

412

**Voltage Dip Immunity of
Equipment and Installations**

**Working Group
C4.110**

April 2010



CIGRE/CIRED/UIE Joint Working Group C4.110

Voltage Dip Immunity of Equipment and Installations

Math Bollen, Convenor (SE), Mark Stephens, Secretary, (US), Sasa Djokic, (GB), Kurt Stockman (BE), Bill Brumsickle (US), Jovica Milanovic (GB), José Romero Gordón (ES), Robert Neumann (GB), Gaetan Ethier (CA), Felipe Corcoles (ES), Alastair Ferguson (GB), Philippe Goossens (BE), Pierre Ligot (BE), Andreia Lopes Leiria (PT), Patrick Marteyn (NL), Alex McEachern (US), John Mentzer (US), Ian McMichael (AU), Ulrich Minnaar (ZA), Koen van Reusel (BE), Francisc Zavoda (CA)

The contribution from S.C. Vegunta, University of Manchester, is acknowledged.

Copyright©2010

“Ownership of a CIGRE publication, whether in paper form or on electronic support only infers right of use for personal purposes. Are prohibited, except if explicitly agreed by CIGRE, total or partial reproduction of the publication for use other than personal and transfer/selling to a third party. Hence circulation on any intranet or other company network is forbidden”.

Disclaimer notice

“CIGRE gives no warranty or assurance about the contents of this publication, nor does it accept any responsibility, as to the accuracy or exhaustiveness of the information. All implied warranties and conditions are excluded to the maximum extent permitted by law”.

ISBN: 978-2-85873-099-5

TABLE OF CONTENTS

Executive summary	5
Abbreviations	8
1. Introduction and scope	9
2. A Description of voltage dips	11
2.1 Introduction	11
2.2 Voltage dip measurements	11
2.3 A typical voltage dip	13
2.4 Existing voltage dip description	13
2.5 An alternative description of voltage dips	14
2.6 Different types of voltage dips	16
2.7 Characteristics of event segments	26
2.8 Characteristics of transition segments	29
2.9 Changes in dip characteristics during the propagation through the network	32
2.10 Summary of voltage dip characteristics	37
2.11 References	38
Appendix 2.A: Classification of voltage dips in three-phase systems	40
Appendix 2.B. Extracting dip type from measurements	43
3. Assessment of equipment and process dip immunity	46
3.1 Introduction	46
3.2 Equipment immunity	47
3.3 Processes immunity	72
3.4 Conclusions	88
3.5 References	89
4. Characterisation and compliance testing of equipment immunity	93
4.1 Introduction	93
4.2 Voltage dip characteristics	93
4.3 Characterisation testing of equipment immunity	94
4.4 Characterisation testing of single-phase equipment dip immunity	100
4.5 Characterisation testing of three-phase equipment dip immunity	100
4.6 Characterisation testing of equipment dip immunity – summary	105
4.7 Compliance testing of equipment dip immunity	105
4.8 Conclusions	107
4.9 References	108
Appendix 4.A: Phase-angle jumps and dip immunity testing	110
Appendix 4.B. Testing of three-phase equipment dip immunity	115

5. Economics of voltage dip immunity	119
5.1 Introduction	119
5.2 Data needed to set voltage dip immunity requirements	119
5.3 Number and characteristics of voltage dips	120
5.4 Financial loss resulting from equipment failure or malfunction	120
5.5 Cost of increasing equipment immunity to voltage dips	127
5.6 Selection of mitigating solutions for individual installations	128
5.7 Setting standards for voltage dip immunity levels	129
5.8 Conclusions	131
5.9 References	132
6. Statistics	134
6.1 Data collection	134
6.2 Main features of each data source	135
6.3 Algorithms	137
6.4 Statistics and charts	141
6.5 Medium and high voltage sites	143
6.6 Low voltage sites	169
6.7 Conclusions from the database	185
6.8 Considerations about rectangular dips	186
6.9 References	187
7. Voltage dip immunity classes and applications	189
7.1 Introduction	189
7.2 Classification of equipment dip immunity and equipment behaviour: Voltage dip immunity	190
7.3 Assessment and improvement of process dip immunity	199
7.4 References	208
Appendix 7.A: Dip contour charts for the representation of dip statistics	210
Appendix 7.B: Sample specifications of voltage dip immunity labels	215
Appendix 7.C: Assessment and improvement of process dip immunity: A case study	220
Appendix 7.D: Testing documentation requirement	241
8. Need for further work	243
8.1 Chapter 2: A description of voltage dips	243
8.2 Chapter 3: Assessment of equipment and process immunity	243
8.3 Chapter 4: Immunity testing and characterization	244
8.4 Chapter 5: Economics of voltage dip immunity	245
8.5 Chapter 6: Statistics	245
8.6 Chapter 7: Dip immunity classes and application	245
8.7 Other power quality disturbances	246
9. Conclusions	247
9.1 Chapter 2: A description of voltage dips	247

9.2 Chapter 3: assessment of equipment and process immunity	247
9.3 Chapter 4: immunity testing and characterization	247
9.4 Chapter 5: economics of voltage dip immunity	248
9.5 Chapter 6: statistics	248
9.6 Chapter 7: Dip immunity classes and application	249

EXECUTIVE SUMMARY

Voltage dips (also known as “voltage sags”) are short-duration reductions in voltage magnitude. Their duration is typically between a few cycles of the power-system frequency and a few seconds. The interest in voltage dips is mainly due to their impact on end-user equipment. Industrial processes may malfunction or shut down due to a voltage dip resulting in significant financial losses.

Voltage dips are due to short-duration increases in current magnitude, whereas voltage dips due to short circuits and earth faults are of most concern for customers.

This report presents the results from an international working group sponsored by CIGRE, CIRED and UIE aimed at improving the understanding of the compatibility between installations and the electricity supply.

The working group was founded in 2006 and its work stretched through the first months of 2009. The working group has addressed a number of aspects of the immunity of equipment and installations against voltage dips and also identified areas where additional work is required. Compatibility between equipment or installations and the power supply can be improved in a number of ways: through alterations to the power grid; by installing mitigation equipment at the interface between the sensitive equipment and the grid; and by improving the equipment or the installation. This report only addresses the latter way of compatibility improvement, without expressing any opinion about whether this is the preferred way.

A description of Voltage Dips

The Working Group has created a detailed description of the different properties and characteristics of voltage dips. This description divides the voltage waveform into pre-dip, during-dip and recovery segments. Special emphasis has been placed on the three-phase character and the occasional non-rectangular character of voltage dips.

Based on this detailed description a summary of voltage-dip characteristics has been created that may be used by equipment manufacturers and researchers as a checklist when they develop new equipment. For voltage dips in three-phase systems the Working Group accepted a classification that is based on the number of phase-to-neutral voltages that show a significant drop in magnitude. The three types of dips (Type I, Type II and Type III) correspond to a significant drop in magnitude for one, two or three phase-to-neutral voltages, respectively.

It is pointed out that measurement of phase-to-neutral voltages gives more information but that the phase-to-phase voltages are more relevant for voltage-dip statistics on medium-voltage and high-voltage networks. Only for low-voltage networks with phase-to-neutral connected loads (as are common in most countries) should the phase-to-neutral voltages form the basis for voltage-dip statistics.

Assessment of equipment and process immunity

The Working Group has presented an overview of the immunity of different types of equipment against voltage dips. The impact of voltage-dip characteristics (magnitude, duration and others) on equipment immunity is illustrated in a quantitative way.

The Working Group introduced a useful new concept, "process-immunity time". A distinction is made between equipment failure and process failure. This distinction allows better economic assessment of the

impact of dips on industrial installations. A methodology has been developed for analysing an entire process, and finding a process immunity time for each individual device or section of that process.

Immunity testing and characterization

The Working Group has made a careful distinction between characterization testing and compliance testing. Guidelines are given for characterizing dip immunity of equipment. The Working Group proposed that the immunity of equipment be presented as a "voltage tolerance curve", which is one simple way for equipment manufacturers and users of their equipment to communicate about dip immunity.

The Working Group recommends that compliance testing includes only two dip characteristics: residual voltage (magnitude) and duration. Based on the presently available knowledge, the Working Group does not see sufficient justification to perform additional tests covering characteristics such as phase-angle jump and point-on-wave.

For characterization testing of three-phase equipment, the Working Group recommends that the equipment immunity be presented by voltage tolerance curves for each of the three types of dips introduced in the report. The working group recognizes that it may not be practical to exactly reproduce these dip types. In many cases approximations need to be made to allow the use of available test equipment. The Working Group is not able to argue for or against any of the methods due to lack of information that any of the methods is significantly less likely to accurately assess compatibility between equipment and the system. For compliance testing of three-phase equipment the Working Group recommends including tests for Type I, Type II and Type III dips. The statistical data presented in the report shows that a significant number of dips are of Type III (balanced dips). However due to a lack of data about the economic consequences of including Type III dips in the compliance testing, the Working Group gives no recommendations regarding the form in which Type III dips should be included in compliance testing.

Economics of voltage dip immunity

The economics of voltage-dip immunity have been described in a qualitative way. A distinction is drawn between dip immunity of individual installations, and dip immunity requirements that are placed on all equipment through standards. The economics of dip immunity at individual installations are well understood, but for a specific installation the data may not always be available. The steps in quantifying the economics of dip immunity at individual installations are described in detail in this report.

So far, the economics of setting global standards for equipment dip immunity are still not understood. The discussions within the Working Group have resulted in a high-level description of the economics involved. The Working Group concluded that economics play an important role in selecting the appropriate voltage-dip immunity, both for individual installations and for immunity requirements that impact all equipment.

Voltage-dip statistics

A global database of voltage-dip statistics has been created. This database includes statistics from several countries on several continents. The database has permitted the Working Group to reach new insights about the ratio between balanced and unbalanced dips, about the variation in number of dips between different sites, about the appropriateness of different equipment immunity requirements, and about the characteristics of three-phase test vectors, among other dip-related questions.

The results of the database analysis are presented as a set of contour charts for Type I, Type II and Type III dips. These contour charts vary significantly for different sites, so a percentile method is used to describe worst-case sites, median sites, and so on.

Dip Immunity Classes and Application

A number of voltage dip immunity classes and associate curves are introduced. These classes will further simplify communication between equipment manufacturers and equipment end-users about dip immunity, while at the same time allowing equipment end-users a sufficient level of choice in selecting equipment. Test levels (combinations of duration and voltage magnitude; for each of the three types of dips) for each class are proposed.

The Working Group emphasizes that performance criteria (how the equipment recovers after a dip-induced trip) are a critical concept next to the immunity requirement. Three performance criteria are proposed: “full operation”; “self-recovery”; and “assisted recovery”. A “voltage-dip immunity label” is introduced that combines the immunity class with the performance criterion for a specific device.

Finally, a systematic methodology, based on the voltage-dip immunity label, is introduced for selecting electrical equipment to ensure a required level of dip immunity for an industrial process.

Further work

Much has been achieved by the Working Group but a number of issues have not yet been resolved. In addition a number of new issues arose from the work done by the Working Group. Finally, a number of issues have not been addressed by the Working Group, mainly due to lack of resources. In the report, some of the issues are presented that, according to the Working Group, should receive more attention in the future. Some of the future work is most appropriate for academic studies. In other cases practical work is needed or new working groups should be formed.

For example: further practical experience is needed for the methods developed within the Working Group; the impact of multiple dips within a short period of time on equipment should be studied in more detail; further study on the way in which the three dip types can be used in characterization and compliance testing. A new working group will be started, sponsored by UIE, to disseminate the results and continue the work done by JWG C4.110.

LIST OF ABBREVIATIONS

ASD: adjustable speed drive

HVAC: heating, ventilation and air-conditioning

DOL: direct on line (with reference to induction motors)

PIT: process immunity time

PCS: plant control system

UPS: uninterruptible power supply

PLC: Programmable Logic Control

EUT: Equipment under test

PCC: Point of common coupling

IEC: International Electrical Committee

SEMI: Semiconductor Equipment Manufacturing Industry

1 Introduction and Scope

Voltage dips are short-duration reductions in voltage magnitude. Their duration is typically between a few cycles and a few seconds. The interest in voltage dips is mainly due to their impact on end-user equipment. Industrial processes may malfunction or shut down due to a voltage dip resulting in significant financial losses.

Voltage dips are due to short-duration increases in current magnitude, whereas voltage dips due to short circuits and earth faults are of most concern for customers.

This report presents the results from an international working group sponsored by CIGRE¹, CIREN² and UIE³ aimed at improving the understanding of the compatibility between installations and the electricity supply. The working group was founded in 2006 and its work stretched through the first months of 2009. The working group has addressed a number of aspects of the immunity of equipment and installations against voltage dips and also identified areas where additional work is required. Compatibility between equipment or installations and the power supply can be improved in a number of ways: through alterations to the power grid; by installing mitigation equipment at the interface between the sensitive equipment and the grid; and by improving the equipment or the installation. This report only addresses the latter way of compatibility improvement, without expressing any opinion about whether this is the preferred way.

Chapter 2 of this report gives a detailed description of voltage dips. The description method goes beyond the single-magnitude-duration description in IEC 61000-4-30, EN 50160, IEEE 1346 and other standards.

Chapter 2 presents a “summary of dip characteristics” to be used as early as possible in the design or development stage of new equipment. In this way future equipment can be made more resilient to voltage dips by design.

Chapter 3 gives an overview of the gathered knowledge on the immunity of individual equipment against voltage dips. The different in immunity for individual devices of the same type is presented.

Chapter 3 also presents a systematic method for making an industrial process more immune to voltage dips without the need to make each individual piece of equipment immune. This chapter introduces the new concept of process immunity time based on the difference between equipment immunity and process immunity. The method presented in this chapter also gives guidance on the measures that could make the process more immune against dips.

Chapter 4 uses the information from Chapters 2 and 3 to select characteristics that should be included in the immunity tests of equipment against voltage dips. A selection is made based on the objectives of the testing. Compliance testing is performed by a certified test laboratory to prove compliance of the equipment with industry, national or international standards. This will involve a limited number of well-defined tests.

Characterization testing is aimed at obtaining more information about the performance of the equipment during voltage dips with a range of characteristics. It will include more tests but with less requirements on the

¹ International Council on Large Electric Systems, <http://www.cigre.org>

² International Conference on Electricity Distribution, <http://www.cired.be>

³ International Union for Electricity Applications, <http://www.uie.org>

specific details of each tests. Characterization testing is a way of exchanging information between the equipment manufacturer and the user of the equipment. Knowledge of the equipment performance during dips facilitates choosing the most appropriate equipment for an industrial installation.

Chapter 5 contains the results of a review of available voltage-dip statistics. No new statistics were gathered for this survey, but instead the results from several studies and sources were merged into one database. The results of the analysis are presented in such a way that the dip statistics can be compared with the equipment performance as obtained from characterization testing.

Chapter 6 presents a discussion on the economics of voltage-dip immunity testing. The choice of immunity objectives and tests in industry, national and international standards should consider the economic impact for all stakeholders.

Chapter 7 combines the results from the different chapters and the introduction of a number of equipment classes based on voltage-dip immunity. These classes are based on the statistics gathered in Chapter 6. A voltage-dip immunity label is proposed that includes, next to the immunity class, requirements for the performance criterion. An overall methodology is presented for selecting equipment powering an industrial process. The methodology combines information on process immunity time and voltage-dip performance of the network, and makes use of the voltage-dip immunity labels.

2 A Description of Voltage Dips

2.1 Introduction

This chapter gives a description of individual voltage dip events as they occur in power systems and at the terminals of end-user equipment. The main aim is to provide a more detailed description of voltage dips than the description based on the use of a single voltage magnitude value and a single duration value. Such an approach should allow better understanding and improved assessment of all relevant factors and parameters that may have an impact on sensitivity of different types of equipment to various voltage dip events. This, in turn, should help the end-users, designers and manufacturers of electrical equipment to quantify, test and compare performance of their equipment in a simple, consistent, transparent and reproducible manner, particularly with respect to prescribed tolerance limits and thresholds. Detailed measurement-based dip definitions, like the ones for residual voltage and duration in IEC 61000-4-30, [1], however, will not be discussed here. Although the working group recognises a general need for detailed measurement-based definitions and does encourage their development, the development of such definitions is not covered in this report.

The description of voltage dips based on one voltage magnitude value (residual voltage or depth) and one duration value, as in [1], is generally suitable as a first step in quantifying, benchmarking and exchanging information on dip performance of the power system. This simplified description, however, does not allow a clear distinction between the wide variety of voltage dip events and, more importantly, possible differences in their impact and effects on operation of different types of equipment. The voltage dip description proposed in this chapter is not intended to replace the method suggested in [1], or any other method. Instead, it is aimed at providing a more detailed description of individual dip events based on additional dip characteristics that will be introduced in later sections.

2.2 Voltage dip measurements

A voltage dip is a reduction in voltage magnitude below a dip magnitude threshold¹ with duration typically from several cycles to several seconds². In a single-phase system and at the terminals of single-phase equipment connected to that system, only one voltage needs to be measured – the supply voltage, which is also the voltage across the terminals of the equipment.

In a three-phase system, or at the terminals of three-phase equipment, a set of three voltages should be measured to obtain complete information about the dip event. This may be a set of three phase-to-neutral voltages, or a set of three phase-to-phase voltages, or a set of three phase-to-ground voltages. Each of the voltage inputs to a measurement instrument is referred to as a "*voltage channel*". In the remainder of this chapter, this term will be used when it is not known (or not relevant)

¹ The most common value for a dip magnitude threshold (including monitoring applications) is 90% of the nominal or declared voltage. For contracting purposes, dip threshold may be set at a lower value.

² The minimum duration for which dip magnitude based on root mean square (rms) voltage value could be calculated is one half of a cycle. The upper limit for dip duration is usually set to distinguish voltage dips from undervoltages, and may be as long as few minutes.

in which way voltages are measured, or available for measurement.

For certain studies, beyond voltage dips, the neutral-to-ground voltage may be important. If the measurement instrument is equipped with the fourth "voltage channel" input and data storage space is not a constraint, recording this voltage is recommended.

If measurements at the terminals of sensitive three-phase equipment are aimed at characterising the quality of supply to this equipment, the choice of measurement channels may be obvious. For three-phase equipment connected with a neutral conductor, the phase-to-neutral voltages are in general more appropriate. For three-phase equipment connected without a neutral conductor, phase-to-phase voltages should be measured.

However, many measurements take place (far) away from the terminals of sensitive equipment and without a specific piece of equipment in mind. Furthermore, the application of the measurement data may be for purposes other than the assessment of equipment sensitivity. Accordingly, voltages used for characterising equipment sensitivity to voltage dips may be different from the measured voltages, e.g. when phase-to-phase voltages are derived from measured phase-to-ground voltages, and then used for the analysis of dip sensitivity of specific equipment. Based on CIGRE TR 261, [2], the following recommendations are made for voltage dip measurements:

- The actual measurement should be performed in such a way that none of the relevant information is lost during the measurement. This implies that it is recommended to measure phase-to-neutral voltages (or phase-to-ground voltages, when the neutral conductor is not available), instead of phase-to-phase voltages.
- The recorded instantaneous voltage waveforms should be stored for every voltage dip and for each available channel, even if the voltage magnitude in that channel does not drop below the dip magnitude threshold. The recordings should be made with a reasonable sampling frequency, so as to enable confident and accurate processing of the recorded dip data³.
- For characterisation towards voltage quality for end-users, the phase-to-phase voltages should be used at medium voltage (MV) or higher voltage levels, or a suitable three-phase characterisation method should be used. These phase-to-phase voltages should be calculated from the measured phase-to-neutral, or phase-to-ground voltages. In solidly or effectively-grounded low-voltage systems, the phase-to-ground or phase-to-neutral voltages should be used, unless the majority of equipment is known to be connected phase-to-phase. Reference [2] states in this context: "*It is recommended for system indices derived from monitoring at high voltage (HV) or extra high voltage (EHV) levels that voltage dip measurements use the phase-to-phase voltages because they give statistically an image that is closer to what the end-user's equipment sees than phase-to-neutral measurements.*"

³ Sampling frequency of 64 samples per cycle is advised as a minimum, resulting in about 5 degrees resolution for phase angle dip characteristics. In some cases, however, this cannot be achieved (e.g. some protection relays use 16 or 32 samples per cycle), when post-processing of recorded dip data may be difficult.

Where only the rms (root mean square) values of the three phase-to-neutral or phase-to-ground voltages are available, the rms values of the three phase-to-phase voltages can be estimated from these values using the method described in Appendix 2.B and [3]. However, it is not possible to estimate the zero-sequence component in the phase-to-neutral voltages from phase-to-phase rms voltages.

2.3 A typical voltage dip

A typical example of a voltage dip measured in a three-phase system is shown in Figure 2-1. The three recorded waveforms correspond to the three phase-to-phase instantaneous voltages measured at the end-user’s 11kV service entrance. In this case, the voltage shows a drop in magnitude in two channels and remains at about the same magnitude in the third channel. As a voltage dip concerns a drop in voltage magnitude, it is more often visualised by plotting the rms voltage as a function of time, which is calculated or derived from the instantaneous voltage data. This rms voltage versus time plot is also shown in Figure 2-1.

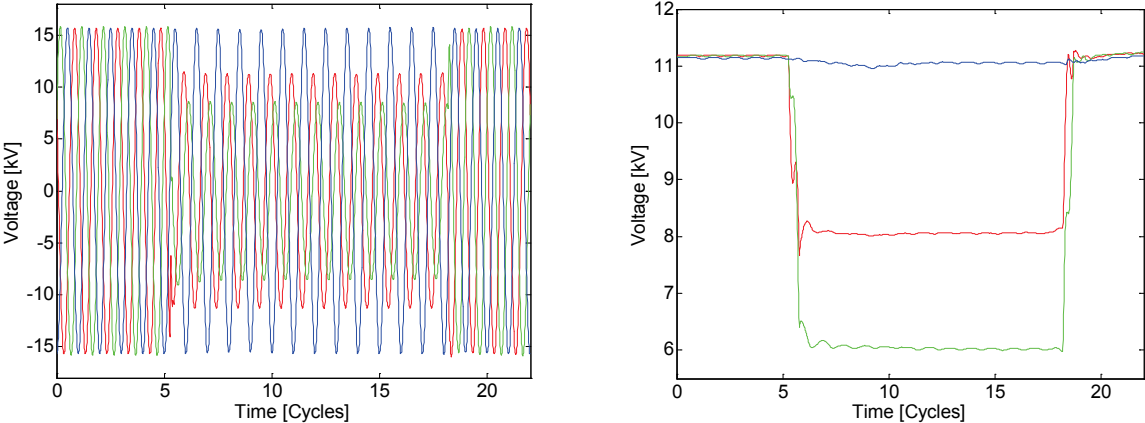

Figure 2-1 Example of a voltage dip recorded in an 11kV network: instantaneous voltage waveform (left) and rms voltage magnitude (right).

The voltage dip event can be quantified by the rms voltage magnitude in each of the three channels as a function of time. This is already shown in the right-hand side of the Figure 2-1, where one-cycle rms voltage values are used to quantify the reduction in voltage magnitude. This is referred to in [2] as a “characteristic versus time”. From the rms voltage magnitude versus time characteristic, so-called “single-event indices” or “single-event characteristics” can be calculated. The two most commonly used single-event indices are the rms voltage magnitude during the dip and the duration of the dip.

2.4 Existing voltage dip description

The IEC power quality measurement standard [1] gives strict measurement-based definitions of the two main characteristics of voltage dips: the “residual voltage” and the “duration”. Both are calculated from one-cycle rms voltage updated every half cycle. For single-channel measurements, the residual voltage is the lowest rms voltage experienced during the event, whereas the duration is the total time during which the rms voltage is below the dip magnitude threshold. The dip magnitude threshold is usually set by the user of the monitoring instrument.

For multi-channel measurements, where more than one phase-to-neutral or phase-to-phase voltage is recorded, the residual voltage is the lowest rms voltage in any of the channels, and the duration is the total time during which the rms voltage in at least one of the channels is below the dip magnitude threshold.

This standard method of characterising voltage dips is introduced to obtain a reproducible way of quantifying the performance of the supply at a specific location. However, reducing voltage recordings in several channels to just two single-value numbers will result in a substantial loss of information when it comes to the description of individual dip events. Two dips with the same residual voltage and duration may have completely different impact on end-user equipment. Therefore, the voltage dip definition in [1] will not be used for the description of dips in this chapter. Instead, an alternative method for the description, analysis and characterisation of individual voltage dip events is introduced in the next section.

Note: The reader is instructed to see [1] and [2, Section 2.4] for more details and further discussion on voltage dip characterisation.

2.5 *An alternative description of voltage dips*

As already mentioned in the previous section, the standard method of describing voltage dips (with one voltage magnitude value and one duration value) leads to a significant loss of information. The main limitation is that the difference between voltage magnitudes in three channels for measurements in three-phase systems is not considered. Additionally, voltage dips do not always fit the pattern “*voltage drop – constant voltage – voltage rise*” (shown in Figure 2-1), i.e., voltage dips are not always rectangular in shape. Finally, phase shift and point-on-wave dip characteristics are not considered in the standard description of dips.

In order to resolve these and some other practical problems encountered during the dip analysis, “dip segmentation method” is introduced in this section. It extends the description of dip events beyond the standard “one constant magnitude and one total duration” approach, and also incorporates into the analysis several almost always neglected characteristics and aspects of dip events.

2.5.1 Transition segments and event segments

The voltage dip in Figure 2-1 is reproduced again in Figure 2-2. The dip recording is divided into distinctive parts (or intervals) called “*dip segments*”.

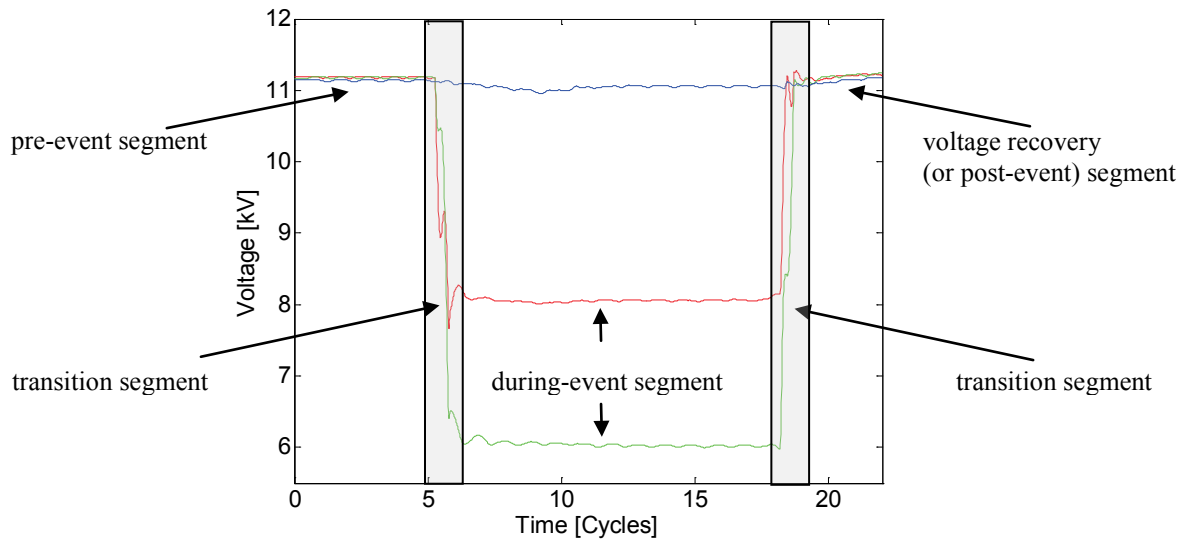

Figure 2-2 Typical voltage dip, with indicated “event segments” and “transition segments”.

The description of voltage dip recording in Figure 2-1 and Figure 2-2 is a combination of five different “segments”:

1. The “*pre-event segment*”, with balanced voltages of about nominal magnitude.
2. The first “*transition segment*”, during which the voltages rather abruptly change from being three-phase balanced and having about nominal magnitude to being unbalanced and with lower than nominal magnitude. For fault-caused dips, the first transition segment includes the instant of fault initiation.
3. The “*during-event segment*”, with, in the most general case, unbalanced voltages of lower than nominal magnitudes.
4. The second “*transition segment*”, during which the voltages rather abruptly change back to being more or less balanced and of more or less nominal magnitude. For the fault-caused dips, like the one shown in the Figure 2.2, the second transition segment includes the instant of fault clearing.
5. The “*voltage recovery segment*”, during which the voltages are balanced and with close to nominal magnitude, but they may show a trend towards a steady state.

The pattern with transition segments and during-event segments is common with practically all voltage dip events. The number of actual segments, as well as their characteristics and features, will vary among the different types of dip events. Some dip events have only one transition segment and no during-event segments (examples will be discussed later), while others may have multiple pairs of transition segments and during-event segments.

It should be noted that not all voltage dips can be described in terms of transition and during-event segments. In some cases, the voltage changes continuously during the whole dip event. These dip events are, however, exceptional, and will not be considered in this report.

2.5.2 *A general description of a voltage dip*

A more complete and detailed description of a voltage dip event than the one in [1] consists of:

- The number of transition segments;
- The time between the transition segments (that is, the durations of all during-event segments);
- The characteristics of each transition segment;
- The characteristics of each during-event segment;
- The characteristics of pre-event and voltage recovery segments.

Characteristics of during-event segments are discussed in Section 2.7, while characteristics of transition segments are discussed in Section 2.8.

2.6 *Different types of voltage dips*

Voltage dips are events characterised by a short-duration reduction of voltage magnitude. Most voltage dips have duration shorter than 1 second, and an upper duration limit of around 1 minute is often used as the longest duration for which a voltage reduction event is considered to be a voltage dip [4], [5]. Events with a reduction in voltage magnitude lasting longer than this “*dip duration threshold*” are referred to as “*undervoltages*”.

In almost all cases, a voltage dip is caused by a short-duration increase in current magnitude. This *overcurrent* condition may occur due to a fault in the power system, or as a result of the switching (i.e. connection) of a load (typically a motor), or switching (i.e. connection) of a network component (e.g. a transformer). A dip due to motor starting is different from a dip due to a fault, while different procedures for fault clearing may also result in different types of dips. Some of the general dip events that may appear at the equipment terminals are discussed in the further text.

2.6.1 *The pre-event segment*

Although the characteristics of a voltage supply are generally specified by explicit mandatory regulations (e.g., [4]), they may still vary both inside and outside the allowed limits and tolerances for relatively long periods of time (e.g. several minutes or hours). Depending on the nature of these variations and equipment sensitivity characteristics, their influence on the actual equipment response to voltage dips ranges from negligible to significant. The most common pre-event characteristics that may have an influence on equipment response to a dip event are related to voltage magnitude and frequency variations, the presence of harmonics and other voltage waveform distortions (e.g. “flat-top” voltage waveforms), as well as to voltage magnitude/phase angle unbalances. When several variations in relevant pre-event segment characteristics occur simultaneously, their impact on end-user’s equipment and processes may be complex and composite. See Chapter 3 for the further discussion of equipment immunity/sensitivity.

2.6.2 *Dips with one transition segment*

Dips due to switching/connection of (large) power supply components and system

loads contain only one transition segment, corresponding to the switching action. In case of motor starting and transformer energising, the current drawn from the supply will show a sudden increase at the instant of switching, followed by a slow decay. Accordingly, the resulting voltage dip will show a sudden decrease in voltage magnitude in the initial part of the dip (corresponding to the transition segment), followed by a slow voltage increase (corresponding to the “voltage recovery segment”). No clear ending point can be identified for most voltage dips due to switching events – the voltage simply slowly recovers until a new post-event steady state voltage is obtained, which may be the same or somewhat different from the pre-event steady state voltage value.

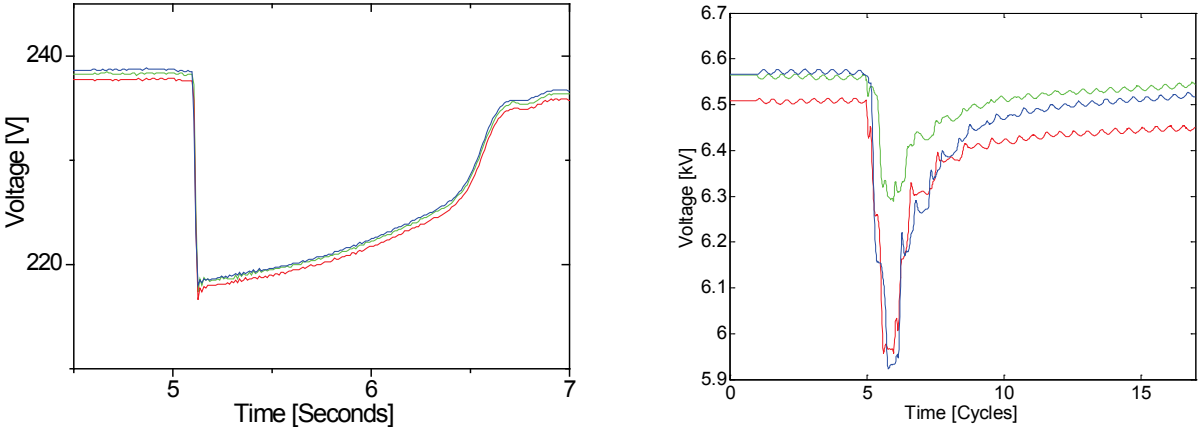

Figure 2-3 Voltage dips due to motor starting (left) and transformer energising (right), having only one transition segment.

Voltage dips due to the starting of large directly connected three-phase motors exhibit the same reduction in voltage magnitudes and the same voltage recovery slope in all three voltage channels (balanced voltage dips), whereas dips due to transformer energising show different voltage magnitudes in different channels (unbalanced voltage dips). Dips due to transformer energising are further associated with a large harmonic distortion, where especially the values of the even harmonics significantly increase during the dip. Figure 2-3 illustrates these two cases.

Dips associated with transformer energising often occur a few seconds to minutes after a dip due to a fault. This happens when a successful autoreclosure of medium-voltage feeder takes place after clearing the fault. The energising of the feeder results in the saturation of all distribution transformers, causing a high inrush current and therefore a voltage dip, which is typically of a short duration. However, depending on the dip magnitude, dip duration and points on wave of dip initiation and ending, as well as on source impedance and locations of transformers and their residual fluxes, there may be a prolonged voltage recovery due to e.g. sympathetic interaction of saturated transformers.

Capacitor energising also leads to events with one transition segment. Although not considered as voltage dips (because of the very short duration), they may have the same impact on sensitive equipment as voltage dips, and therefore should be considered during the design and utilisation of end-use equipment. Capacitor-energising events will not be further discussed in this report.

2.6.3 *Dips with two transition segments*

Voltage dips due to short circuit faults contain at least two transition segments and one during-event segment, which are directly correlated with the initiation, presence and clearing of the fault. Additional transition segments and event segments may occur in case of so-called “developing” faults, when the number of initially faulted phases changes during the fault (e.g. when a single-phase fault develops into a two-phase or three-phase fault), or when the fault is cleared by different circuit breakers (or different breaker poles) at considerably different instants in time. Voltage dips with more than two transition segments are discussed in more detail in Section 2.6.5.

An example of a voltage dip with two transition segments is shown in Figure 2-1. Generally, different fault types will result in different voltage magnitudes in different phases, i.e. in different types of voltage dips. Unbalanced (or asymmetrical) three-phase dips, with different voltage magnitudes in different voltage channels, are the most common. The voltage magnitudes during the fault (i.e. during-event segment voltages) further depend on the fault location in relation to the location of the monitoring equipment, or location of affected end-user equipment. An informative discussion on the voltage magnitudes associated with fault-caused voltage dips is given in Appendix 2.A at the end of this chapter.

In rare cases, the motor starting or the transformer energising results in a protection misoperation and tripping of the motor or transformer. This may also result in a dip with two transition segments, where the first one corresponds to the switching instant and the second to the instant of the protection tripping.

2.6.4 *The voltage recovery segment after a fault-caused dip*

The presence of a period during which voltage recovers from its reduced during-event value to its post-event steady state value is common to all dip events, including those caused by short circuit faults. As the short circuit faults are a rather severe disturbances, the actual time needed for a full recovery of the system voltages after a fault may be quite long. There are several phenomena that may be of interest after the primary cause of the dip event is cleared and voltage starts to recover. The examples include post-fault dip, post-event phase shift, the occurrence of high inrush currents, transformer saturation and multiple dip events.

In Section 2.6.12 it is shown that dips due to switching events (e.g. dips due to motor starting or transformer energising) are associated with a relatively long voltage recovery segment. Dips due to faults may also have a long voltage-recovery segment. For example, rotating machines close to the fault location will lose a large part of the magnetic energy in the air gap and will start to slow down, depending on their moment of inertia. Upon fault clearing, these machines will draw a large current, causing a slow and prolonged voltage recovery. Similarly, transformers may go into saturation after the fault is cleared, resulting in a further slowing down of the voltage recovery. As the underlying phenomena are similar (re-energising of rotating machines and transformers), resulting dip recovery segments show strong similarities to those due to motor starting and transformer energising. An example is shown in Figure 2-4.

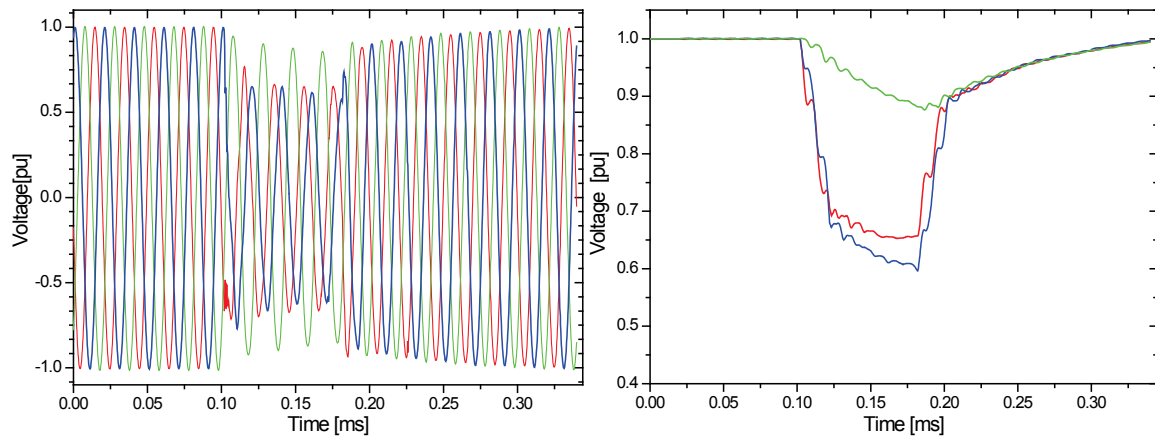

Figure 2-4 An example of a fault-caused voltage dip with a longer voltage recovery segment due to motor load: instantaneous voltages (left) and rms voltages (right).

After clearing the fault and re-establishing steady state supply conditions, two general “scenarios” can be discerned. In the case of a self-extinguishing fault, the system will return to its pre-fault conditions, and all during-dip changes in voltage magnitudes and phase angles will be cancelled. In the second “scenario”, the faulted part of the system and some system elements will be disconnected after the action of the circuit breakers/reclosers, and post-event voltage magnitudes and phase angles will differ from their pre-event values. The difference between the phase angles of the pre-event and post-event instantaneous voltages is a “*post-event phase shift*” [6]. Post-event phase shift is usually the same in all channels, as phase angle unbalance of pre-event and post-event steady state voltages should be within the range of 1%-2%, or smaller. In the first “scenario”, post-event phase shift is equal to zero.

As discussed previously, practically all voltage dips are either caused by, or closely correlated with the events that exhibit an increase of the system currents. The most common examples of such overcurrent conditions include short circuit faults, energising of system components and load switching actions. In case of the high inrush current at the dip ending, these same underlying phenomena are either occurring simultaneously, when they have combined effect, or are taking places in succession to each other, when they have aggregate effect. For instance, in case of fault-caused dips in weak systems with large motors, the motors will loose large part of their air-gap magnetic energy and will start to slow down during the dip. After the dip ending, rebuilding of the air-gap magnetic field and reacceleration will take place, resulting in the occurrence of high inrush current. Although caused by a dip event, this inrush current is load-specific, as it is influenced by the combined effects of two underlying phenomena: a) short circuit fault, which determines during-event voltage supply conditions, and b) post-event load re-energising (or restarting), which determines supply conditions during the voltage recovery. This suggests that there is a complex relationship between the occurrence of inrush currents and other characteristics of dip events (e.g. point-on-wave of dip ending). From the equipment sensitivity point of view, high inrush current at the dip ending may cause activation of the overcurrent protection (e.g. fuses) and subsequent disconnection/tripping of the equipment, although the equipment may otherwise ride-through the dip. The further discussion of high inrush current at the dip ending is provided in Chapter 3.

2.6.5 Dip events with more than two transition segments

Although the majority of voltage dips contains one or two transition segments, a sizeable minority of dip events contain three or four transition segments. Dips with more than four transition segments do occur, but are rare.

Dips with more than two transition segments are especially found among the events with longer total duration, which usually have a more severe impact on equipment. These events are therefore more significant than what would be expected by observing their percentage contribution to the total number of voltage dips events.

An example of a voltage dip due to a developing fault is shown in Figure 2-5.

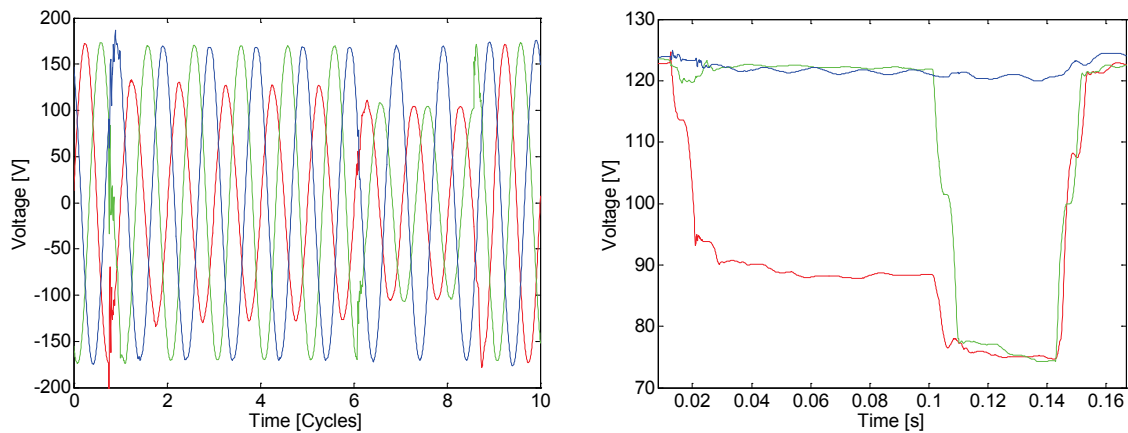

Figure 2-5 Voltage dip with three transition segments due to a developing fault: instantaneous voltage waveforms (left) and rms voltages versus time (right).

Voltage dips with more than two transition segments also occur when the fault-clearing time is significantly different for two breakers on the two ends of a supply feeder or transmission line. This could be due to a protection failure, or because a fault is seen in zone 2 by the distance protection at the other line terminal. An example of such a voltage dips recorded in 11kV network is shown in Figure 2-6.

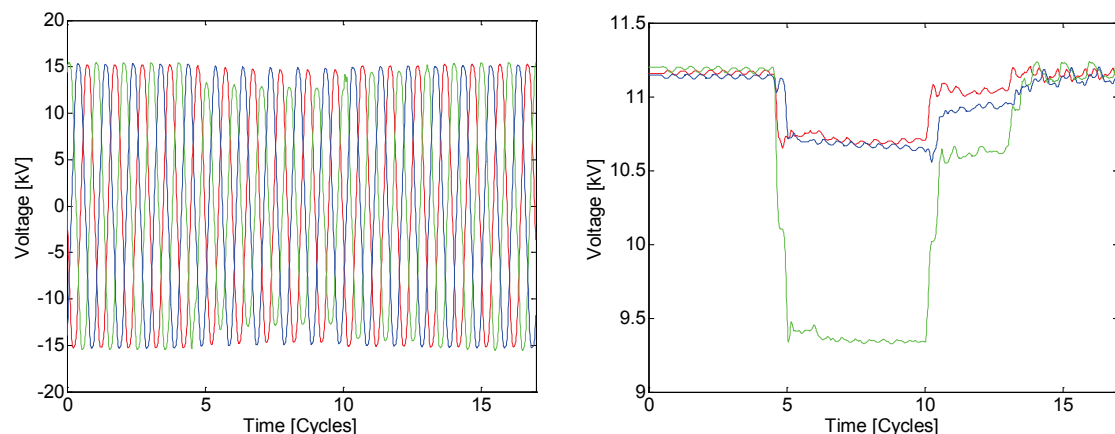

Figure 2-6 Voltage dip with three transition segments due to a difference in fault-clearing times: instantaneous voltages (left) and rms voltages (right).

A voltage dip due to a developing fault being cleared at different instants would result in a dip with at least four transition segments. An example of a dip recording with four transition segments is shown in Figure 2-7.

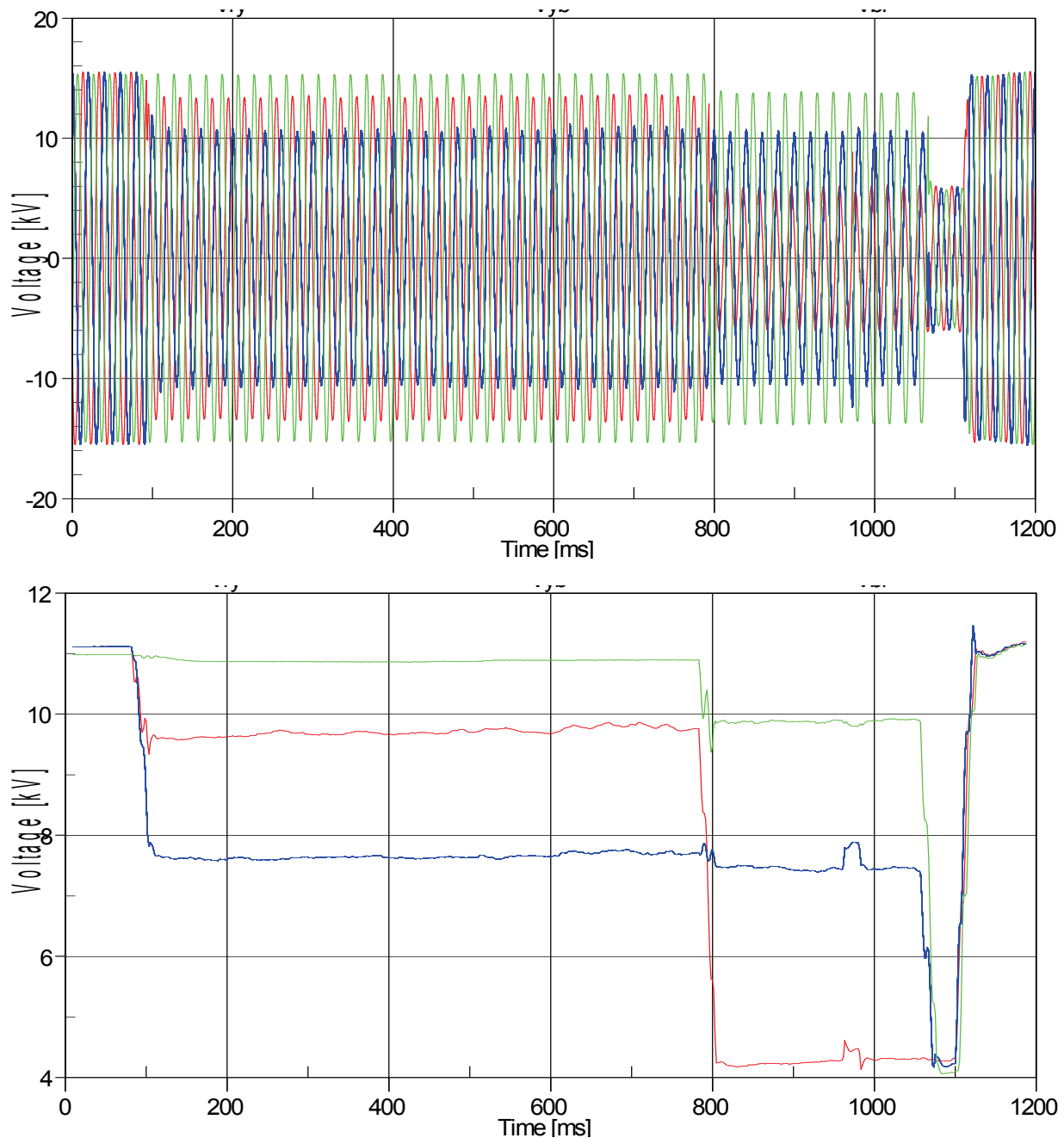

Figure 2-7 Voltage dip with four transition segments and three during-event segments: instantaneous voltages (top) and rms voltages (bottom).

2.6.6 Voltage swells

A voltage swell is an event with a short-duration increase of the voltage magnitude above a swell magnitude threshold⁴ [1]. Like voltage dips, voltage swells come in

⁴ The most common value for a swell magnitude threshold is 110% of the nominal or declared voltage.

different forms. Voltage swells occur, for example, in the voltage between the non-faulted phases and ground/neutral for an earth fault. The overvoltage in the phase-to-ground voltages may be up to almost 2 per unit, although values above 1.7 per unit are rare. It should be noted, however, that these high overvoltages occur in impedance or non-effectively earthed systems, and that they usually do not occur at the terminals of end-user equipment. Also, they are rarely present in the phase-to-phase voltages.

Minor increases in voltage magnitude, from 1.2 to 1.4 per unit, between the non-faulted phases and ground occur in solidly or effectively earthed systems. These swells do appear at the terminals of end-user equipment.

Voltage swells also occur due to sudden load reduction and due to capacitor energising. Swells due to load reductions are typically of much longer duration than swells associated with faults in the system.

Examples of the phase-to-ground voltages due to a single-phase-to-ground fault and a two-phase-to-ground fault are shown in Figure 2-8. The voltage between the faulted phase(s) and ground reduces (i.e. it shows a voltage dip), while the voltage between the non-faulted phase(s) and ground increases (i.e. it shows a voltage swell).

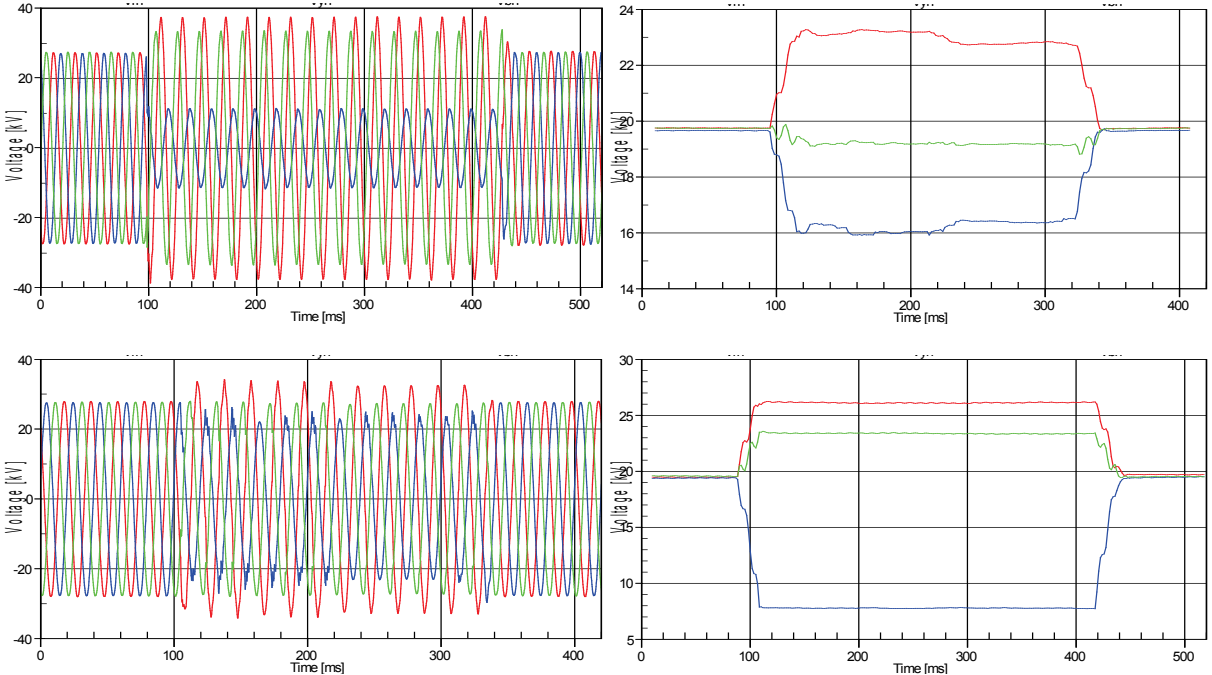

Figure 2-8 Event due to a single-phase-to-ground fault (top) and due to a two-phase-to-ground fault (bottom). The plots show phase-to-ground instantaneous voltages (left) and rms voltages (right).

When analysing the three phase-to-ground voltages, one may argue whether the three-phase events shown in Figure 2-8 should be referred to as a voltage dip, or as a voltage swell, or possibly both as a swell and as a dip. It is important to realise that this ambiguity exists as a classification problem when interpreting three-phase voltage dip and voltage swell statistics. Again, it should be noted that the number of swells due to faults in most cases becomes small, or even zero, when phase-to-phase voltages or voltages at the equipment terminals are used for description of

these events.

2.6.7 Combinations of dips and interruptions

A voltage dip will develop into an interruption when the location of the measurement instrument is downstream of the fault-clearing device in a radial system. An example of such an event is shown in Figure 2-9.

Incorrect coordination or unselective activation of protection devices could also result in a voltage dip followed by a short interruption.

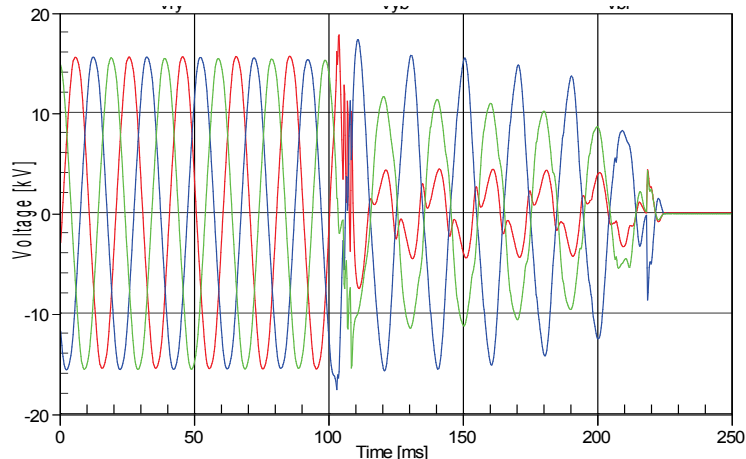

Figure 2-9 Voltage dip developing into an interruption.

2.6.8 Multiple dip events

Voltage dips do not occur evenly or randomly spread throughout the year, but show a clustering in time. During the periods of adverse weather (e.g. lightning storms) more dips occur than during the periods of normal weather. This could result in two or more dip events occurring shortly after each other. Multiple dip events (or "dip sequences") may also occur due to automatic reclosing actions after a fault. An unsuccessful autoreclosure attempt (activated by a permanent fault) results in two similar voltage dips due to a fault, while a successful autoreclosure (activated by a transient fault) may result in one dip due to a fault, possibly followed by another dip due to the energising of the distribution transformers on the faulted feeder. Each unsuccessful autoreclosure attempt will add one more dip to the sequence

An example of a multiple dip event is shown in Figure 2-10. When two or more voltage dips occur within a short time-span, the assessment of their effects on equipment performance needs some additional consideration. For example, equipment may be capable of riding through a particular dip, but the second identical or even less severe dip may cause the equipment malfunction. In other cases, however, the second dip event is of no relevance, as the equipment already malfunctioned due to the first dip event.

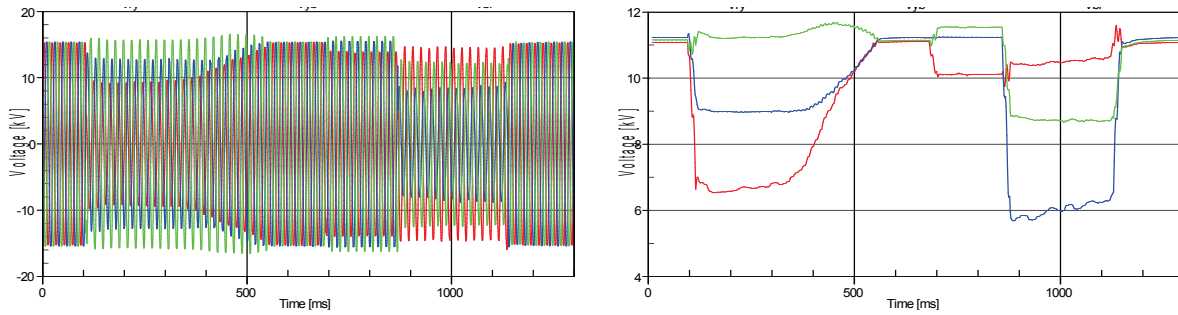

Figure 2-10 An example of a multiple dip event: instantaneous voltages (left) and rms voltages (right).

Many discussions are ongoing concerning the way in which multiple dip events should be described with a limited number of characteristics, where the main aim is to bring a multiple dip event back to two characteristics: residual voltage and duration as in [1]. The aim of this so-called “time aggregation” is to allow the representation of the quality of supply at a given location in the form of statistics on residual voltage and duration. The time-aggregation is usually applied in case of repetitive dips, resulting in a representation of a whole dip sequence with the single most severe dip from the sequence, neglecting all other dips within the time aggregation interval. From the equipment/process sensitivity point of view, this approach may be misleading, as equipment may not malfunction when exposed only to the most severe dip from the sequence, but it may malfunction when that dip occurs in a sequence with the other dips.

Multistage dips, dip-sequences, and combinations of dips, interruptions and swells are typical examples of a series of individual dip events occurring either in different phases/channels or at different but close moments in time. The impact of a series of events on equipment/process performance may be very different from the impact of each individual event in the established series. Even though equipment may malfunction immediately after the initial event in the sequence or series, and therefore does not “see” or react to any further dip event in the sequence, there may be other equipment malfunctioning at any later temporal stage.

2.6.9 Events with relatively long duration

The dip/swell events discussed in the previous sections were all of durations typically up to a few seconds. As fault clearing times rarely exceed a period of a few seconds, this is a reasonable upper limit for the duration of dip events due to faults. Motor starting and transformer energising dips have characteristics different than fault-caused dips, but also typically do not last longer than several seconds. However, voltage dips and swells may also occur due to load increases or decreases lasting longer than several seconds. Such events could last minutes through hours, although in a well-designed system the operation of voltage control equipment or manual action will bring the voltage back within acceptable limits in a few minutes.

Voltage dips and voltage swells with the durations exceeding one minute are typically referred to as “undervoltages” and “overvoltages”, respectively.

2.6.10 Short interruptions

Similarly to a voltage dip, short interruption is also defined as a short duration event

characterised by a reduction of voltage magnitude. For a short interruption, however, voltage magnitude is close to zero. Usually, a threshold of 10% of the nominal voltage ("interruption magnitude threshold") is used to detect an interruption.

The IEC power-quality measurement standard [1] regards an event as a short interruption only if all three voltages are simultaneously reduced below the interruption magnitude threshold. An event with only one or two voltage magnitudes below the threshold is referred to as a voltage dip under that definition.

During a short interruption, the voltage is either equal or close to zero, and all during-event voltage waveform characteristics are of no importance. Therefore, the characterisation of short interruptions (i.e. their during-event segments) takes place only through their duration. Further to this, short interruptions have a steady state pre-event segment and, in case of successful supply voltage restoration, voltage recovery segment.

When an interruption lasts longer than a few minutes (the actual duration limit differs between different countries and in different standard documents), it is referred to as a long interruption.

The majority of long and short interruptions are due to faults. Therefore, the start of a (short or long) interruption typically contains a transition segment similar to the transition segment of a voltage dip due to a fault. An example of a multiple short interruption event due to a fault and unsuccessful autoreclosing on a radial 130kV line (measured at 10kV) is shown in Figure 2-11.

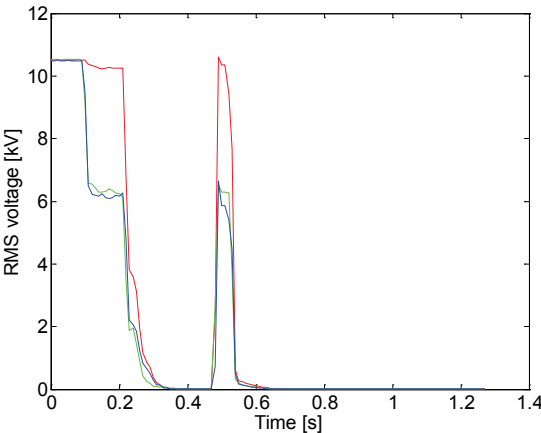

Figure 2-11 Multiple short interruption event caused by a fault and unsuccessful autoreclosing.

Interruptions not caused by faults are in some cases associated with overvoltages at the start of the interruption.

Finally, short interruptions also occur when end-user has designed a bus transfer switch, allowing a fast transfer from the (disturbed or interrupted) main power supply system to the alternative supply or energy source. The duration of these short interruptions is determined by the total time required for the successful transfer, which depends on the selected type of the transfer switch (static or electromechanical) and applied transfer procedure (e.g. fast or in-phase transfer).

2.7 Characteristics of event segments

During an event segment, the voltage dip is a power-system frequency phenomenon, as the fundamental component (50 or 60 Hz) is dominant in the voltage waveform. Based on the previously introduced definitions of the “transition segments” and “during-event segments”, it is therefore sufficient for dip description to consider the power-system frequency properties of the voltages in different channels. The vast majority of voltage dip recordings contain either one or three voltage channels, where single-channel measurements are mainly used in low-voltage networks. For each channel, the voltage can be described by a phasor (see Section 2.9.1), having an rms magnitude and a phase angle, where the phase angle is expressed relative either to the pre-event voltage in that channel, or to the pre-event voltage in the reference channel.

For the measurements in three channels (i.e. for three-phase measurements), three complex voltages characterise each during-event segment, and voltage magnitude unbalance and voltage phase angle unbalance are two other dip characteristics of interest.

The voltage magnitude in some cases shows a slow decrease or increase during an event segment. This holds, for example, during the voltage recovery segment associated with motor starting or transformer energising events discussed before.

In some cases, the waveform distortion during an event segment is significantly higher than during the normal/pre-event operation. This concerns mainly events associated with transformer saturation, but may be also related to the occurrence of different types of transients visibly imposed on voltage waveform, featuring, for example, multiple voltage waveform zero-crossings, which may cause malfunction of some electronic equipment (e.g. those using phase-locked loop, PLL, circuits).

2.7.1 Dip duration

The duration of a dip is usually defined (e.g. [1]) as the total time for which a reduction in the voltage magnitude that is qualified as a voltage dip is present in at least one of the affected/available voltage channels. This is referred to here as the “*total duration of the voltage dip*” or simply “*dip duration*”.

When describing the voltage dip as a sequence of event segments and transition segments, it becomes much more difficult to give a quantifiable definition of the duration of each segment, or to specify an exact borderline between the transition segments and event segments. While the existence and general location of each dip segment could be often easily identified after a simple visual inspection of the dip voltage waveform, establishing an automatic and reproducible method for determining the duration of a dip segment is a much more difficult task. Furthermore, the calculated durations of the transition segments are strongly influenced by the method used for their detection and location, and by the way in which instantaneous voltage data are processed. On the other hand, the information about the duration of a during-event segment sometimes could be obtained in a straightforward way, if the underlying event (or cause of the dip) is known. For example, duration of a fault-caused dip could be closely correlated with the time between the instants of fault initiation and fault clearing. Generally, dip duration in a single channel is a sum of the

durations of all transition segments and during-event segments, plus the duration of that portion of voltage recovery segment during which the voltage magnitude is still below the dip magnitude threshold.

There will be additional problems in determining dip duration when so called post-fault dip occurs after the fault clearing. Due to a slow voltage recovery in such cases, it is not possible to point out any particular moment in time at which the dip ends, and alternative approaches are required for quantifying the dip duration.

2.7.2 Dip magnitude

According to [1], dip magnitude shall be quantified by the so-called “residual voltage”, obtained by applying a one-cycle rms calculation to the instantaneous voltage waveform. The lowest value of the one-cycle rms voltage in any of the voltage channels during the dip (i.e. while the rms voltage in any of the channels is below the dip magnitude threshold) is the residual voltage. Alternative methods have been proposed in literature, including the fundamental component, the maximum voltage and the missing voltage.

When using the description of a voltage dip event in terms of transition and event segments, a voltage magnitude value is to be allocated to each event segment in each voltage channel. This approach is in accordance with a more general “per-phase” (i.e. “per-channel”) characterisation of dip events, which provides a more correct description of unbalanced polyphase dip events. Accordingly, during-event dip magnitude in each of the affected channels can be described by a phasor, having the corresponding voltage magnitude and voltage phase angle values. The rms voltage magnitude then can be calculated from the instantaneous voltage, using one-cycle (or half-cycle) sliding or refreshing window, and commonly used limits for distinguishing dips from allowed variations of steady state supply voltages and from short interruptions (dip magnitude threshold and interruption magnitude threshold values) could be directly applied. Alternatively, the average 1-cycle rms value could be used, or the rms value taken over the whole segment.

For the pre-event segment, a longer window can be used to calculate the voltage magnitude, for instance 3 seconds or 10 minutes.

In some cases, the voltage magnitude during an event segment shows a slow decay or increase. In that case, the rate-of-change of voltage magnitude may be used as an additional characteristic.

During the recovery segment, the voltage magnitude often shows a slow increase towards a new steady-state value. A recovery time constant, a half-time, or a rate-of-change of voltage magnitude may be used as the additional characteristics. Note that the average voltage magnitude cannot be used during the recovery segment, as there is no well-defined ending point.

2.7.3 Phase-angle

The phase angle of the voltage waveform during an event segment is often different from the phase angle of the voltage waveform prior to the event. This difference is referred to as the “phase shift” or “phase-angle jump”. For dips with multiple during-

event segments, the phase shift may be different for each during-event segment.

Like the voltage magnitude, the phase angle may vary with time for a during-event segment, either as a continuous function of time, or in discrete steps (e.g. when dip type changes, as in developing faults). If this is the case, the highest (in absolute value) or the average value of the phase shift may be used for characterisation of during-event segments. For multi-channel measurements, the voltage phase angles (i.e. phase shifts) are typically different in different channels.

The phase shift may be quantified from the difference in voltage waveform zero-crossings between the pre-event and during-event instantaneous voltages. Alternatively, the argument (phase angle) of the fundamental components of the pre-event and during-event voltages may be used to quantify the phase shift. For that purpose, either a discrete Fourier transform or an alternative method can be used.

The voltage-recovery segment shows a post-dip phase shift that slowly tends towards a steady-state value. This value may be close to zero (i.e. the voltage phase angles are the same as the pre-event phase angles), or deviate up to a few degrees from zero.

2.7.4 Three-phase unbalance

When performing measurements in a three-phase system, the measurement consists typically of three voltage channels. These may be phase-to-ground, phase-to-neutral, or phase-to-phase voltages. The voltage magnitude and phase angle are typically different in different voltage channels. Currently, there is no generally adopted consensus on how to describe and quantify this difference.

A number of methods exist to quantify the unbalance between the three voltages in case of unbalanced polyphase dips in a three-phase system.

- By using per-phase representation of dip events, based on the voltages in the three individual channels. Usually, either the rms voltages, or the complex voltages (magnitude and phase angle) are used for dip characterisation and classification with these methods (e.g. [7]).
- By using a classification of dips into a number of types corresponding to typical combinations of voltage magnitudes and phase angles for dips due to symmetrical and non-symmetrical faults. The event is characterised through a dip type and a so-called “characteristic voltage”. A brief overview of this classification method is given in Appendix 2.A at the end of this chapter [8, 9].
- By counting the number of voltage channels in which the voltage magnitude drops below the dip threshold. A “single-channel dip” is associated with a drop below the dip threshold for one channel, whereas the voltage magnitude remains above the threshold in the two other channels. The lowest voltage magnitude is next used to characterise the event.
- By using positive, negative and zero-sequence voltage components. Again, this may be related to calculation of voltage magnitudes only, or complex voltages.

2.7.5 *Waveform distortion*

For most voltage dips, the voltage waveform distortions present in the during-event and voltage-recovery segments are similar to those in the pre-event segment. There are however some notable exceptions.

Voltage dips due to transformer energising are associated with a high level of waveform distortion in the recovery segment. Even harmonics (especially second and fourth) dominate initially. The harmonic spectrum changes when the voltage recovers, with the fifth harmonic becoming the dominant one at the latter stages of the dip. The second harmonic voltage (expressed as a percentage of the nominal voltage) may reach similar levels to the experienced drop in the rms voltage.

For fault-caused dips, transformer saturation may occur upon fault clearing. In such cases, the voltage-recovery segment will exhibit similar waveform distortion as during a transformer-energising dip. Finally, some dip events may have high-frequency transients imposed on the instantaneous during-dip voltage waveform of fundamental frequency. These transients are generally short-lived and may have oscillatory character, usually representing damped oscillations occurring at the initial or final stage of the dip event.

2.8 **Characteristics of transition segments**

Transition segments are related to the periods of time during which the voltage magnitude, and possibly other dip characteristics, experience fast changes. These changes are too fast to be followed (or accurately described) by the rms voltage values, so alternative methods are needed to describe the transition segments. In many cases, the details of the transition segment are not considered when describing the voltage dip. This is in part a consequence of choosing rms voltage to describe the dip. This section discusses some of the characteristics of the transition segments.

Typically, transition segments could be closely correlated either with the occurrence of the particular system events, or with the execution of certain actions (e.g. with the initiation and clearing of short circuit faults, or with the switching/connection of large loads). All these phenomena could be collectively referred to as the “*underlying cause of the transition segment*”, or “underlying cause of the dip” to which the transition segment belongs.

2.8.1 *Point-on-wave*

In the most general case, the underlying cause of a transition segment may occur anywhere on the voltage waveform. To quantify this, the term “*point-on-wave*” has been introduced. Defining and calculating (or identifying) point-on-wave characteristics from the available voltage waveforms in a consistent and reproducible manner is a problem that has not been solved yet. The main interest, however, is usually on the “*point-on-wave of dip initiation*”, related to the first transition segment, and “*point-on-wave of dip ending*” (or “*point-on-wave of voltage recovery*”), related to the last transition segment, as these may have a strong influence on the behaviour of some types of equipment (see Chapter 3).

The point-on-wave may be defined as the phase angle of the fundamental

instantaneous voltage corresponding to the instant at which the underlying cause takes place. In most cases, this is a workable definition, although the choice of reference voltage is not always obvious. Additional problems are related to the identification of point-on-wave of initiation/ending values when dip starts or ends gradually, without a sudden voltage drop from pre-dip to during-dip waveform, or sudden voltage rise from during-dip to post-dip waveform, as well as to quantifying the influence of dip propagation on point-on-wave values [10]. As it can be seen below, the identification of the point-on-wave values is also more difficult when dip initiation or dip ending takes place in multiple steps.

2.8.2 Rate-of-change of voltage

During a voltage dip, the transition from one steady state (or event segment) to another steady state is not immediate, but takes place with a certain speed. The corresponding temporal change of the instantaneous voltage during the transition segments is denoted here as the “rate-of-change of voltage”. The rate-of-change of voltage may be expressed as an average or maximum value, describing either positive or negative voltage gradients. The inclusion of this dip characteristic facilitates further investigation of the typical relationships between the durations of the transition segments and different types/causes of dip events. For example, distinction/correlation could be made based on this characteristic between dips originating at different voltage levels. The rate-of-change of voltage may also help in assessing how dip characteristics change in the propagation to the terminals of end-user equipment.

An example of a dip with a high rate-of-change of voltage is shown in Figure 2-12. The dip was measured at the low-voltage wall-outlet in an apartment, and is due to a fault in the local low-voltage network. The related instants of the initiation and ending of the underlying event are clearly visible for both transition segments.

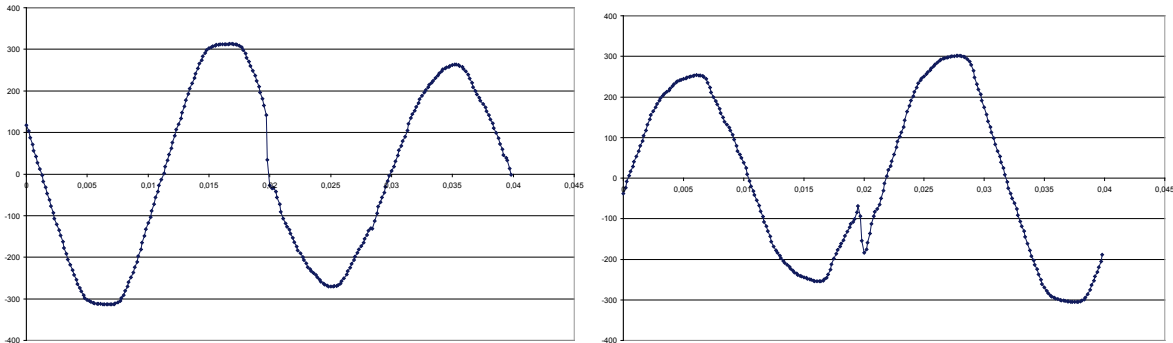

Figure 2-12 Voltage dip with a high rate-of-change of voltage at the fault initiation (left) and at the fault clearing (right).

An example of a much lower rate-of-change of voltage is shown in Figure 2-13. The voltage dip was measured using the same instrument, but at the apartment wall-outlet in another country. The dip was due to a fault at subtransmission level. It is much harder to see when the underlying event takes place.

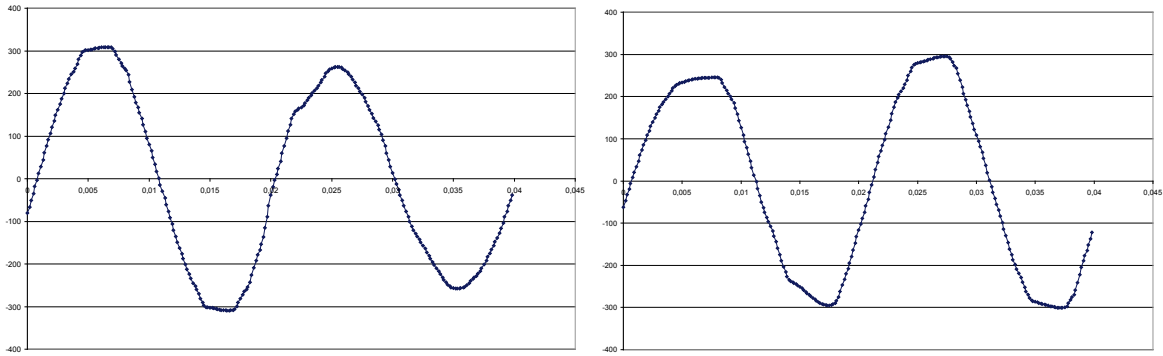

Figure 2-13 Voltage dip with a small rate-of-change of voltage at the fault initiation (left) and at the fault clearing (right).

2.8.3 Damped oscillations

As the transition segments represent the transfer between two steady states (e.g. between pre-dip and post-dip supply conditions), or two quasi-stationary states (e.g. between two consecutive during-event segments), they are often associated with damped oscillations. In circuit theory, these are referred to as “transients” and their origin and spread through the system are very similar to the transients due to, for example, capacitor energising. An example of a damped oscillation, measured at low voltage, is shown in Figure 2-14. Frequency of oscillation and damping time constant may be used as the additional characteristics, e.g. for a better correlation and identification of different types and causes of dip events, as well as for the analysis of the influence of dip propagation and pre-event system operating/loading conditions on dip characteristics. Both frequency of oscillation and damping time constant depend on the location and characteristics of the fault (underlying cause of the dip).

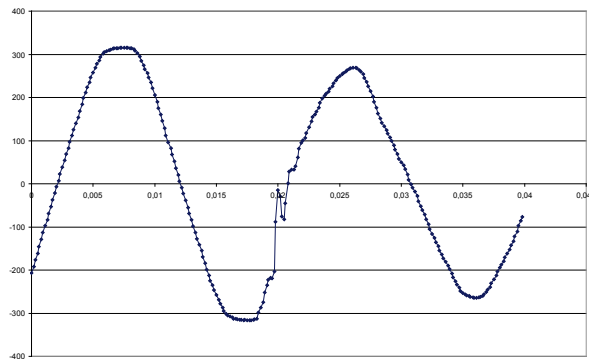

Figure 2-14 Voltage dip with a damped oscillation in the first transition segment.

2.8.4 Initiation and ending of a dip event in multiple steps

In some cases, a fault develops from a single-phase (or two-phase) to a multi-phase fault within one cycle, making it difficult to distinguish between the individual instants (or stages) in the measured/recorded voltage dip data. Accordingly, both stages of the developing fault will be contained in one transition segment. An example of such a dip event is shown in Figure 2-15.

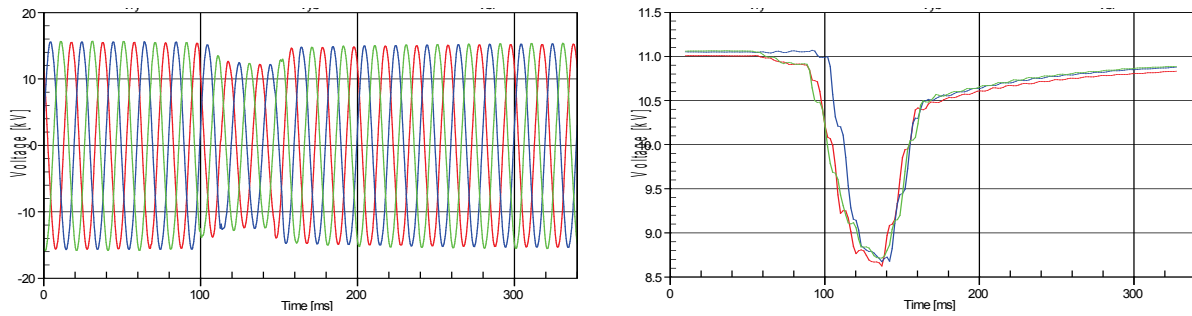

Figure 2-15 Voltage dip due to a fast-developing fault: instantaneous voltages (left) and rms voltages (right).

In case of two-phase-to-ground and three-phase faults, fault clearing will take place in two or three steps, as each breaker pole clears the corresponding fault current at a current waveform zero crossing. Two examples of fault clearing for a dip due to a three-phase-to-ground fault are shown in Figure 2-16.

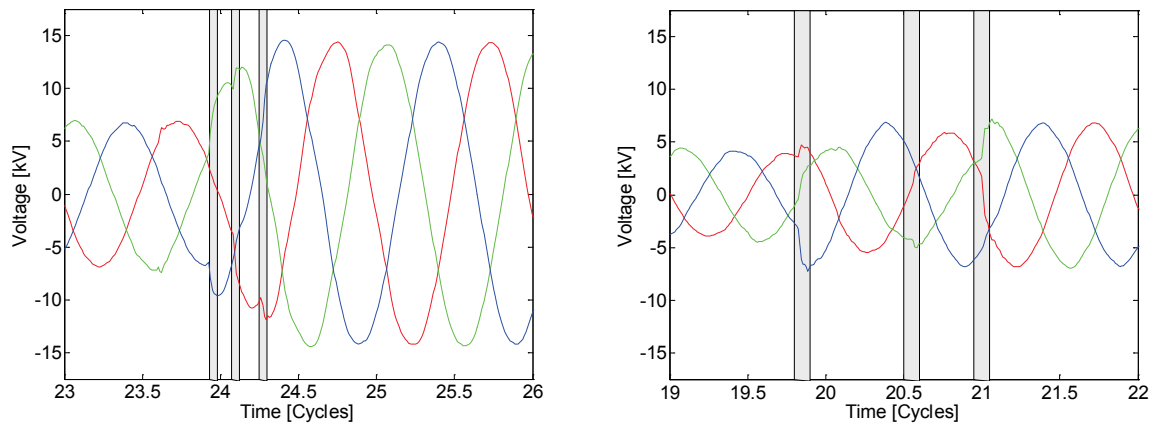

Figure 2-16. Voltage recovery in three stages after a three-phase fault with about 0.3 cycles between individual breaker poles (left) and with about 0.7 and 0.4 cycles between individual breaker poles (right).

2.9 Changes in dip characteristics during the propagation through the network

When a short circuit fault occurs at a certain system location, different voltage dips (i.e. dip events with different characteristics) will be measured and experienced at the different locations within the system. This phenomenon is commonly known as a *"dip propagation"*. A general rule is that the experienced/measured voltage dips will become less severe at the locations further away from the fault position. The term "less severe" implies here that the drop in voltage magnitude in all affected phases/channels is smaller, and that the corresponding change in phase angles is less pronounced.

The biggest changes in voltage dip characteristics occur when moving from the voltage level at which the fault occurs (e.g. HV or MV levels) to the terminals of the sensitive end-user's equipment (e.g. LV level). The characteristics of all interposing/intervening transformers (e.g. their earthing arrangements and winding connections) will have a significant impact on the changes in voltage magnitudes and

phase shifts. This is discussed further in Section 2.9.1. Voltage magnitudes and phase angles of the voltage dips measured at the lower voltage levels are additionally influenced by the (large) motor loads and generator units connected there. This is discussed briefly in Section 2.9.2. These two sections discuss only changes in event segments. The changes in transitions segments when dips propagate through the network are not well understood, in part due to a lack of detailed measurement data. A very brief discussion of this topic is presented in Section 2.9.3.

2.9.1 Changes in event segments due to transformer winding connections

Different transformer winding/earthing connections change the magnitudes and phase angles of the phase-to-ground and phase-to-phase voltages. A distinction can be made, in this context, between the three general types of transformers:

- Transformers that do not have any impact on the voltages; these are only Yy transformers, grounded/earthed on both sides.
- Transformers that remove the zero-sequence voltage in part or completely. The zero-sequence voltage is completely removed by, for example, a Dd transformer, or by a Yy transformer that is not grounded. A three-winding Yyd transformer removes only a part of the zero-sequence voltage.
- Transformers that change phase-to-phase voltages into phase-to-neutral voltages (and the other way around), and also remove the zero-sequence voltage. The best-known example is the Dy transformer.

The table below illustrates the changes in voltage magnitudes and phase angles of the three phase-to-neutral voltages for dips due to different fault types after propagating through one and two Dy transformers. The following comments should be made for interpreting the table.

- The (green) phasors with smaller arrowheads indicate the pre-fault phase-to-ground voltages; the (red) phasors with bigger arrowheads indicate the during-fault phase-to-ground voltages.
- For all diagrams, the phasor in one of the phases is given in the horizontal direction. Any phase shift between primary and secondary side of a transformer is not considered here.
- Any transformer that changes phase-to-phase voltages into phase-to-neutral voltages (i.e. the third type in the above list) will change the dip type in the same way as a Dy-transformer.
- The impact of removing the zero-sequence voltage is the same as the impact of two Dy transformers.
- The impact of changing from phase-to-ground measurements to phase-to-phase measurements is the same as the impact of a Dy transformer.

Type of fault	Dip at faulted voltage level	Dip after one Dy transformer	Dip after two Dy transformers
Three-phase			
Single-phase in a solidly-grounded network			
Single-phase in a non-solidly-grounded network			
Two-phase			
Two-phase-to-ground in a solidly-grounded network			
Two-phase-to-ground in a non-solidly grounded network			

A dip due to a three-phase fault does not change at all due to the transformers: a

voltage drop in three phases remains a voltage drop in three phases. However, a voltage drop in one or two phases, due to an asymmetrical fault, changes character (i.e. dip type change) when transferring through a Dy transformer.

A single-phase fault in a non-solidly grounded system will not cause any significant drop in voltage behind a Dy transformer. The impact of a two-phase-to-ground fault in a non-solidly-grounded system is the same as that of a two-phase fault behind a Dy transformer.

The transfer of voltage dips through transformers can be also described in terms of the dip classification presented in Appendix 2.A at the end of this chapter. This is shown in the table below.

Type of fault	Dip at faulted voltage level	Dip after one Dy transformer	Dip after two Dy transformers
Three-phase	Type III	Type III	Type III
Single-phase in a solidly-grounded network	Type I with a zero-sequence voltage	Type II	Type I
Single-phase in a non-solidly-grounded network	Zero-sequence voltage only.	No dip	No dip
Two-phase	Type II	Type I	Type II
Two-phase-to-ground in a solidly-grounded network	Type II with a zero-sequence voltage	Type I, but with a bigger drop in magnitude in all phases than the common Type I	Type II, but with a bigger drop in magnitude in all phases than the common Type II
Two-phase-to-ground in a non-solidly grounded network	Type II with a zero-sequence voltage	Type I	Type II

2.9.2 Changes in event segments due to motor load and generators

The tables presented in the previous section assume a fully passive load, or more precisely, a load that behaves as a constant impedance during the fault. When significant motor loads or generators are present on the secondary side of the transformers, they will impact the dip voltage magnitudes and phase angles as well.

Motor load and generation based on rotating machines will have a low impedance for the negative-sequence component, so that any unbalanced dip will result in a high

negative-sequence current. Accordingly, the negative-sequence voltage will be damped when moving towards the load. This reduction of the negative-sequence voltage when moving from the faulted voltage level to the terminals of equipment has been observed in many dip recordings. The ultimate result is that the voltage dip becomes more balanced.

Motor load and any type of generation will initially maintain the positive-sequence voltage. The result is that the drop in positive-sequence voltage becomes smaller when moving towards the load. This phenomenon is strongest for synchronous generators. For long-duration dips in areas with significant amount of motor loads, however, the positive-sequence voltage may drop during the later stage of the dip, as the motors will draw higher currents. This phenomenon is also commonly observed in voltage dip recordings.

2.9.3 Changes in transition segments

No significant changes in the point-on-wave of transition segments are expected to occur when the dip propagates through the system, except for the usual phase rotation, which depends on the transformer vector group (multiple of 30°). However, no study has been conducted to confirm this statement.

As mentioned before, the characteristics of a drop or rise in voltage magnitude during a transition segment depend on the location of the fault and the location of the equipment. Although this implies that the corresponding characteristics of the transition segments will change to some extent in the propagation through the network, no further conclusions can be drawn without a detailed investigation of this subject.

2.10 Summary of voltage dip characteristics

This section gives a summary of the different characteristics of voltage dips that have been introduced in this chapter. The summary can be used as a “check-list” for a fast and transparent assessment of equipment and process sensitivity to voltage dips during all stages of equipment and process design. It is expected that by considering this check-list at the early stages of the development and design of equipment, (at least some of) the future dip immunity concerns and problems may be avoided.

Dip Characteristic	Description
Pre-event segment	
Characteristics of the pre-event segment	The actual or expected values of the pre-event voltage magnitudes, voltage phase angles, harmonics and other waveform distortions, voltage magnitude/phase angle unbalances and frequency variations.
During-event segment	
Dip magnitude	Quantifies the reduction in voltage magnitude below the “dip magnitude threshold”, usually expressed as a root mean square (rms) value of the measured or calculated instantaneous voltage in any of the affected input voltage channels.
Dip duration	The time for which a reduction in voltage magnitude that is qualified as a voltage dip is present in a single voltage channel (per-phase/per-channel dip duration), or in at least one of the affected voltage channels (the total dip duration).
Dip shape	Dips with the constant during-event rms voltage magnitudes are rectangular dips, while non-rectangular dips have variable rms voltage magnitude.
Dip voltage magnitude unbalance	In case of polyphase dip events, voltage magnitudes in different channels are typically different.
Dip phase shift (phase-angle jump)	Change of during-dip voltage magnitudes is often associated with a change in corresponding voltage phase angles. In case of polyphase dips, voltage channels with different voltage magnitudes will typically have different phase shifts.
Dip phase angle unbalance	For polyphase dips with different voltage magnitudes and/or different phase shifts in different channels, during-dip voltages will also experience voltage phase angle unbalance.
Dip waveform distortion and transients	Dips due to transformer energising are associated with a high level of harmonic distortion, while some dips have high-frequency transients imposed to the fundamental component of the during-dip instantaneous voltage.
Transition segment	
Dip initiation	The first transition segment marks the instant of dip initiation (i.e. the transition from pre-dip voltage to during-dip voltage), manifested as a sudden drop in voltage magnitude at the start of the dip.
Point-on-wave of dip initiation	Phase angle of the instantaneous pre-dip voltage waveform at which (main) transition from pre-dip voltage to during-dip voltage is initiated.
Phase shift at the dip initiation	The majority of fault-caused voltage dips are associated with a change in voltage phase angles. Accordingly, sudden drop in voltage at the start of the dip event is usually accompanied by a distinctive shift/jump in corresponding phase angle.
Multistage dip initiation	At the dip initiation, the drop in voltage magnitude in affected channels may take place in several steps due to e.g. developing faults. The corresponding multiple stages may occur at a sub-cycle time scale, or at a time scale of several seconds.

Dip ending	The last transition segment marks the instant at which underlying cause of the dip is cleared, manifested as a sudden voltage rise. It is followed by a voltage recovery segment, during which voltage may be still below the dip magnitude threshold.
Point-on-wave of dip ending	Phase angle of the post-dip instantaneous voltage waveform at which (main) transition from during-dip voltage to post-dip voltage is finished.
Phase shift at the dip ending	Sudden rise in voltage at the end of the dip event is usually accompanied by a distinctive shift/jump in corresponding phase angle, which usually cancels all the changes in phase angles in affected channels, except for the post-dip phase shift.
Multistage dip ending	The voltage magnitude rise at the end of fault-caused dips may take place in several steps due to e.g. difference in circuit breaker opening instants in different phases or at different network locations. The corresponding multiple stages may occur at a sub-cycle time scale, or at a time scale of up to one second.
Rate-of-change of voltage	The transition from one steady state to another steady state (or from one quasi-steady state to another quasi-steady state) takes place with a certain speed. Corresponding temporal change of voltage is denoted as the rate-of-change.
Damped oscillations	Transition segments are often associated with damped oscillations, whose frequency of oscillation and damping time constant depend on the location/type of the fault and characteristics of system load and generation.
Voltage recovery (post-event) segment	
Voltage recovery	During the voltage recovery segment, the voltages are usually balanced and with close to nominal magnitude, but they may show more or less prolonged trend towards their steady state values, with voltages still below the dip magnitude threshold.
Post-fault dip (prolonged voltage recovery)	After the initial cause of the dip (e.g. short circuit fault) has been cleared and after the affected voltages already experienced main rise in magnitudes, the voltage magnitudes in affected channels may be still below the dip magnitude threshold. This part of the voltage recovery segment is termed as the post-fault dip.
Post-dip phase shift	Phase angle difference between the steady state pre-dip and post-dip voltages. Typically occurs when a (faulted) part of the network is disconnected in order to clear the underlying cause of the dip, influencing a change in system impedances.
Multiple dip events (dip sequences)	Multiple dip events occur within a short period of time, ranging from less than one second up to one minute. Examples include successive dips due to adverse weather (e.g. lightning storms), or dips due to automatic reclosing actions after the occurrence of a short circuit fault.
Composite dip events	In case of polyphase events, voltage dips in some of the affected channels may be accompanied by interruptions and/or swells in the other channels.

2.11 References

- [1] Electromagnetic compatibility (EMC), Part 4: Testing and measurement techniques, Section 30: Power quality measurement techniques, IEC Standard 61000-4-30, International Electrotechnical Commission, 2003.
- [2] CIGRE, Power Quality Indices and Objectives, Report 261, Joint CIGRE/CIRED Working Group C4.07, October 2004.
- [3] M.H.J. Bollen, P. Goossens, A. Robert, “Assessment of voltage dips in HV networks: Deduction of complex voltages from the measured rms voltages”, *IEEE Trans. on Power Delivery*, Vol. 19, no.2, April 2004, pp.783-790.

- [4] EN 50160, Voltage characteristics of the electricity supplied by public distribution systems, Cenelec, 1999.
- [5] IEEE Std. 1159, Recommended Practice for Monitoring Electric Power Quality, 1995.
- [6] S. Ž. Djokić and J. V. Milanović, "Advanced Voltage Sag Characterisation I: Phase Shift", *IEE Proc. - Generation, Transmission and Distribution*, Vol. 153, No. 4, pp. 423-430, July 2006.
- [7] S. Ž. Djokić, J. V. Milanović, D. Chapman, M. McGranaghan, and D. S. Kirschen, "A New Method for Classification and Presentation of Voltage Reduction Events", *IEEE Trans. on Power Delivery*, Vol. 20, No. 4, pp. 2576-2584, October 2005.
- [8] M.H.J. Bollen, Understanding power quality – voltage sags and interruptions, IEEE Press, 2000.
- [9] M.H.J. Bollen, I.Y.H. Gu, Signal processing of power quality disturbances, Wiley – IEEE Press, 2006.
- [10] S. Ž. Djokić and J. V. Milanović, "Advanced Voltage Sag Characterisation II: Point on Wave", *IET Proc. - Generation, Transmission and Distribution*, Vol. 1, No. 1, pp. 146-154, January 2007.

Appendix 2.A: Classification of voltage dips in three-phase systems

The classification of voltage dips in three-phase systems remains a point of discussion. A possible classification, based on the different types of faults that may occur in a three-phase system, is presented in this appendix. Only the resulting classification is presented here. For the derivation of the classification and characteristics, as well as for the further mathematical details, the reader is referred to the literature [8, 9].

In its basic form, the classification distinguishes between the three general types of voltage dips that may occur at the terminals of sensitive equipment.

Dip Type III is a drop in voltage magnitude that is equal for the three voltages.

Dip Type II is a drop in voltage magnitude that takes place mainly in one of the phase-to-phase voltages.

Dip Type I is a drop in voltage that takes place mainly in one of the phase-to-ground voltages.

The definition of these three dip types is given in mathematical terms in Figure 2-17, where it should be noted that all quantities are complex voltages. The "characteristic voltage" has a magnitude and phase angle which are typically different from those of the pre-event voltage. The difference in magnitude depends on the fault location; the difference in phase angle depends on the difference in X/R ratio between the source and the faulted feeder. When the X/R ratios are similar, this will result in a small phase-angle difference. On the other hand, a large difference in X/R ratio results in a large difference in phase angle. The difference in phase angle between the pre-event voltage and the (during-event) characteristic voltage is referred to as the "characteristic phase angle jump".

In Figure 2-18 the resulting voltage dips are shown as phasor diagrams for zero characteristic phase angle jump and for a characteristic phase angle jump of 30 degrees. The magnitude of the characteristic voltage is in all cases equal to 50%.

The illustrative instantaneous voltage waveforms and the rms voltage versus time for the different dip types are shown in Figure 2-19 and Figure 2-20, respectively.

$\begin{aligned}\bar{U}_a &= \bar{V} \\ \bar{U}_b &= -\frac{1}{2}\bar{V} - \frac{1}{2}j\bar{V}\sqrt{3} \\ \bar{U}_c &= -\frac{1}{2}\bar{V} + \frac{1}{2}j\bar{V}\sqrt{3}\end{aligned}$ <p>Type III</p>	$\begin{aligned}\bar{U}_a &= \bar{E} \\ \bar{U}_b &= -\frac{1}{2}\bar{E} - \frac{1}{2}j\bar{V}\sqrt{3} \\ \bar{U}_c &= -\frac{1}{2}\bar{E} + \frac{1}{2}j\bar{V}\sqrt{3}\end{aligned}$ <p>Type II</p>	$\begin{aligned}\bar{U}_a &= \bar{V} \\ \bar{U}_b &= -\frac{1}{2}\bar{V} - \frac{1}{2}j\bar{E}\sqrt{3} \\ \bar{U}_c &= -\frac{1}{2}\bar{V} + \frac{1}{2}j\bar{E}\sqrt{3}\end{aligned}$ <p>Type I</p>
--	---	--

Figure 2-17. Mathematical expressions for different types of voltage dips due to faults that may occur in a three-phase system. \bar{E} is the pre-event voltage; \bar{V} is the "characteristic voltage" of the dip.

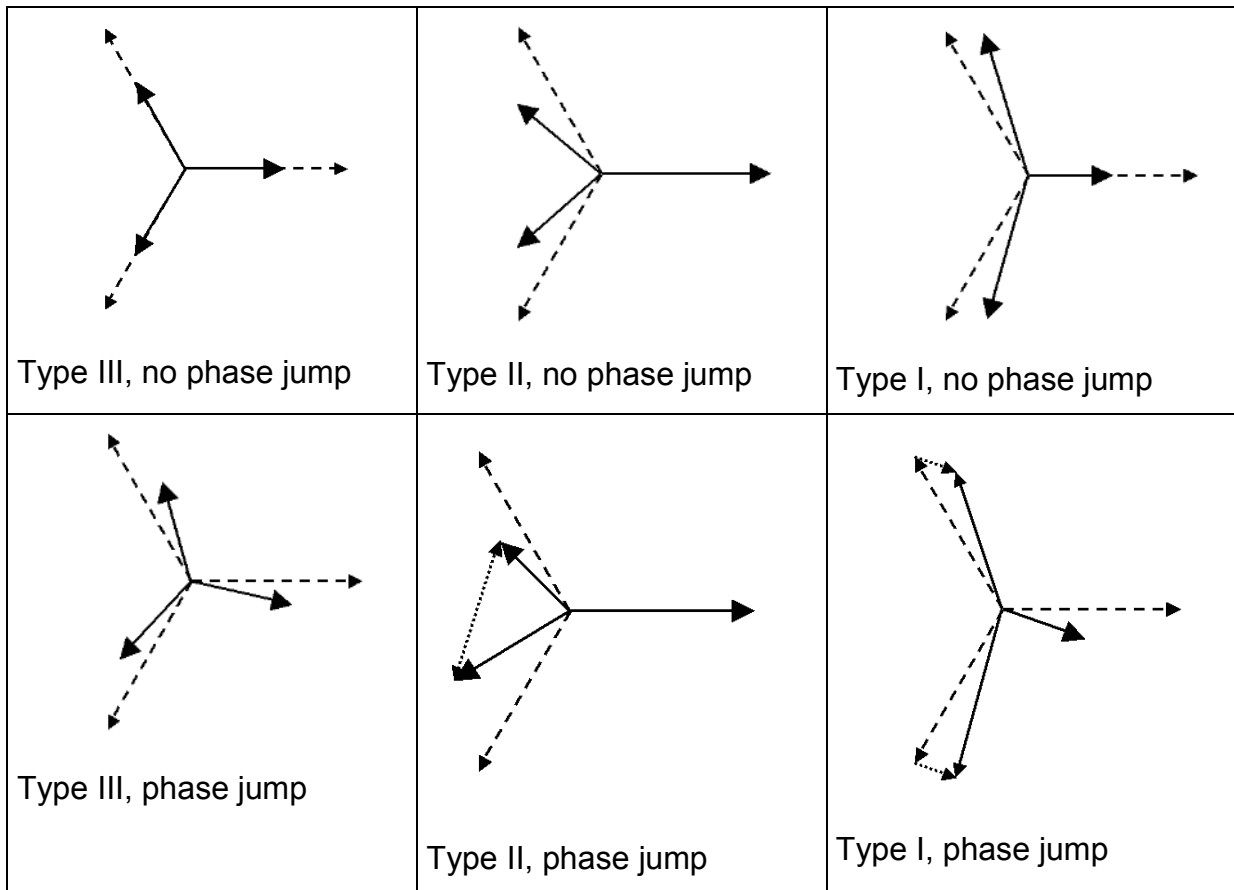

Figure 2-18. Phasor diagrams for different types of voltage dips due to faults that may occur in a three-phase system: without (top) and with (bottom) characteristic phase-angle jump.

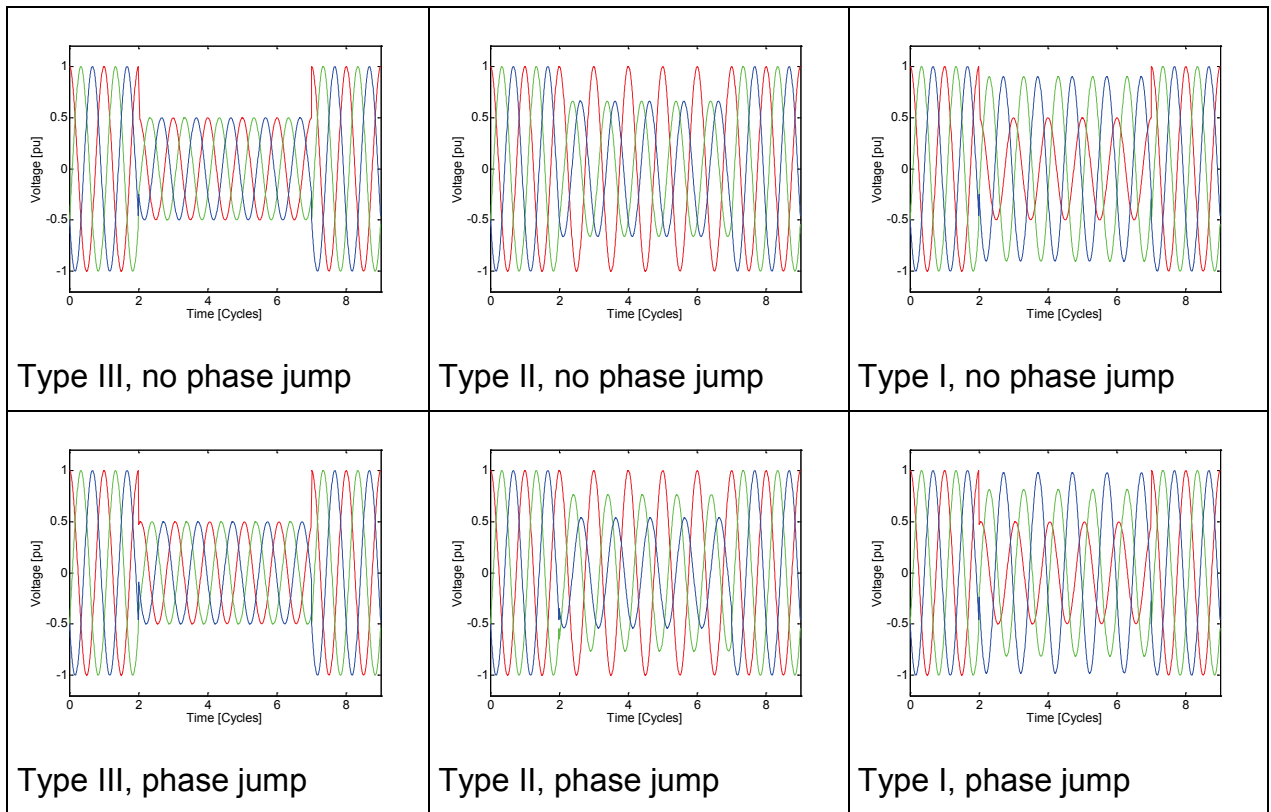

Figure 2-19. The instantaneous voltage waveforms for different types of voltage dips due to faults that may occur in a three-phase system: without (top) and with (bottom) characteristic phase-angle jump.

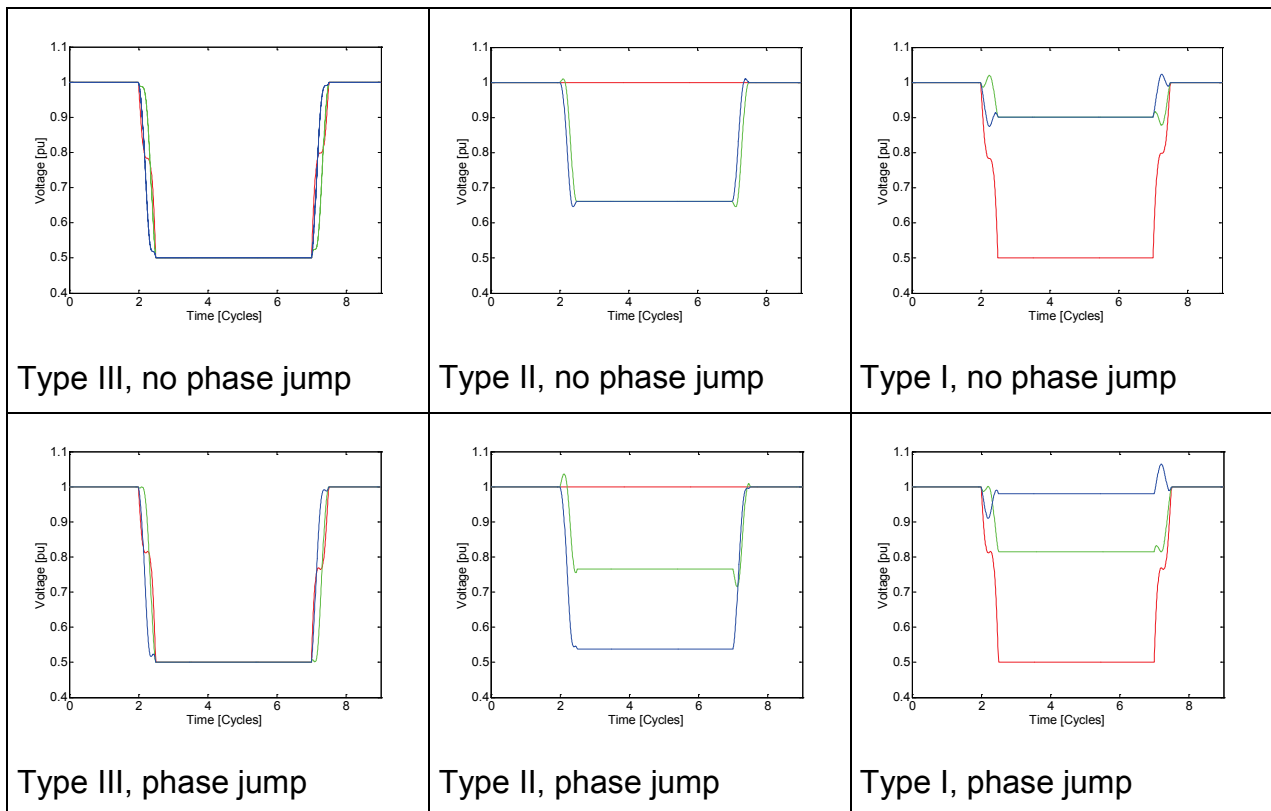

Figure 2-20. The rms voltage vs. time plots for different types of voltage dips due to faults that may occur in a three-phase system: without (top) and with (bottom) characteristic phase-angle jump.

Appendix 2.B. Extracting dip type from measurements

A classification of voltage dips into three types, based on the number of voltages that show a drop in magnitude, has been proposed in Annex 2A. In this annex, we will present methods for extracting the dip type from recordings.

Different methods can be used, based on the availability of the complete voltage waveforms or of the voltage magnitudes only. In all cases, three magnitudes or three waveforms should be available. One of the methods, the one to be discussed first, has been used for the database presented in Chapter 5.

Three voltage magnitudes

The method described below has been proposed in [3] to extract the type of voltage dip and to estimate the magnitudes of the phase-to-phase voltages from the magnitudes of the phase-to-neutral voltages.

The method takes place in two steps. In the first step a distinction is made between a drop in one voltage and a drop in two voltages: Type I versus Type II. Type III dips fall randomly in one of the two other types. In the second step, the Type III events are detected among the two other types.

We will start by assuming that the three phase-to-neutral voltages are available. The three rms voltages are ranked in ascending order, V_x , V_y , V_z , where $V_x < V_y < V_z$, after which dip events are split into two groups:

- $V_z - V_y < V_y - V_x$, the highest rms voltages closer together. This group contains Type I and Type III events.
- $V_z - V_y > V_y - V_x$, the lowest rms voltages are closer together. This group contains Type II and Type III events.

A distinction is made between Type I and Type III events by comparing the average of the two highest rms voltages with the lowest rms voltage. If this difference is less than a value obtained from theoretical considerations [3], the dip is classified as Type III (balanced); otherwise it is classified as Type I. The following conditions are used, where V_x , V_y and V_z are expressed in per-unit:

- $\frac{1}{2}(V_y + V_z) < 0.3 + 0.7 \times V_x \rightarrow \text{Type III.}$
- $\frac{1}{2}(V_y + V_z) \geq 0.3 + 0.7 \times V_x \rightarrow \text{Type I.}$

A distinction is made between Type II and Type III in a similar way: the highest rms voltage is compared with the average of the two lowest voltages.

- $V_z < 0.3 + 0.7 \times \frac{V_x + V_y}{2} \rightarrow \text{Type III.}$
- $V_z \geq 0.3 + 0.7 \times \frac{V_x + V_y}{2} \rightarrow \text{Type II.}$

The method can be easily extended to phase-to-phase voltages (i.e. the same algorithm can be applied to phase-to-phase voltages), but Type I must be changed to Type II, and vice versa.

This method has been used in Chapter 5 to extract the dip type for phase-to-neutral measured dip events from the global voltage dip database. An example of the above algorithm written in Python⁵ is as follows:

```
# Input voltages are va, vb and vc.
v = [va, vb, vc]
(vx, vy, vz) = v.sort()

if (vz-vy)<(vy-vx): # I+III
    if 0.5*(vy+vz)<(0.3+0.7*vx):
        type = 'III'
    else:
        type = 'I'
else: # II+III
    if vz<(0.3+0.7*(vx+vy)/2.0):
        type = 'III'
    else:
        type = 'II'

print type
```

Three voltage waveforms

When the complete voltage waveform is available, more information can be extracted than when only rms voltages are available. The dip type can be estimated more accurately and additional information can be extracted. This is described in detail in **Fel! Hittar inte referenskölla.**, including two different methods for extracting dip type from recorded voltage waveforms. One of those methods calculates six rms voltages and is straightforward to implement; the other method is based on symmetrical components and more difficult to implement but even more accurate. Here, we will only present the method using six rms voltages.

Assume that the three phase-to-neutral voltages $v_a(t)$, $v_b(t)$, and $v_c(t)$ are available. As a first step the zero-sequence voltage is removed:

$$v_0(t) = \frac{1}{3} \{v_a(t) + v_b(t) + v_c(t)\}$$

$$v_a'(t) = v_a(t) - v_0(t)$$

$$v_b'(t) = v_b(t) - v_0(t)$$

$$v_c'(t) = v_c(t) - v_0(t)$$

Next six rms voltages are calculated:

$$V_a = rms(v_a')$$

$$V_b = rms(v_b')$$

$$V_c = rms(v_c')$$

⁵ Python is a dynamic object-oriented programming language. See www.python.org for more details.

$$V_{ab} = rms\left(\frac{v_a - v_b}{\sqrt{3}}\right)$$

$$V_{bc} = rms\left(\frac{v_b - v_c}{\sqrt{3}}\right)$$

$$V_{ca} = rms\left(\frac{v_c - v_a}{\sqrt{3}}\right)$$

If one of the rms voltages V_a , V_b or V_c is the lowest of the six, the dip is of Type I.

If one of the rms voltage V_{ab} , V_{bc} , V_{ca} is the lowest of the six, the dip is of Type II.

If the six rms voltages are about equal, the dip is of Type III.

When the three phase-to-phase voltages $v_{ab}(t)$, $v_{bc}(t)$, and $v_{ca}(t)$ are available, the phase-to-neutral voltages minus zero-sequence are calculated by using the following expressions:

$$v_a'(t) = \frac{v_{ab}(t) - v_{ca}(t)}{\sqrt{3}}$$

$$v_b'(t) = \frac{v_{bc}(t) - v_{ab}(t)}{\sqrt{3}}$$

$$v_c'(t) = \frac{v_{ca}(t) - v_{bc}(t)}{\sqrt{3}}$$

3 Assessment of Equipment and Process Dip Immunity

3.1 Introduction

To harden processes against voltage dips, it is very important to understand the process. For dip immunity purposes, processes can generally be divided into two distinctive groups. The first group of processes can operate without supply voltage for a longer time (e.g. several seconds or longer, as in case of chemical reactors). The processes from the second group stop shortly after the occurrence of a voltage interruption or a voltage dip (e.g. within 100ms, as in cases of extrusion, steel and paper mills). For the second group of processes, an understanding of the responses of individual equipment to voltage dips is required, in order to take correct measures to harden the entire process against dips.

This chapter starts with a review of equipment responses to voltage dips, as reported in available literature. Among the other types of equipment, the impact of a voltage dip on direct on-line induction motors, adjustable speed drives (ASDs), contactors, programmable logic controllers (PLCs), personal computers (PCs) and large rectifiers is discussed.

For each general type of equipment, different manufacturers often implement different hardware components, different topologies and different control algorithms. Therefore, the discussion of equipment performance is in this report kept rather generic. For direct on-line induction motors, their behaviour and their impact on the supply system during and after the dip is discussed. For contactors and equipment containing power electronics, best-case and worst-case rectangular voltage tolerance curves are presented, based on the current technology of tested devices reported in literature. The equipment parameters and tripping mechanisms responsible for high sensitivity of the equipment are discussed. Knowledge of these parameters and tripping mechanisms can indicate what type of mitigation technique is best suited to immunise the equipment.

The second part of this chapter, Section 3.3, discusses process behaviour in the presence of voltage dips and proposes a general framework to identify the most critical equipment within the process. The method is centred around a concept referred to as “Process Immunity Time” (PIT). The PIT links equipment behaviour with the process behaviour, indicating whether the normal operation of equipment is critical, or equipment can be switched off and restarted after the dip without causing interruption of the process.

3.2 *Equipment immunity*

This section describes typical behaviour of several general types of equipment during voltage dips. Numerous parameters influence whether the equipment will trip/malfunction as a result of a voltage dip. This makes studying and describing of their impact a complex and time consuming task. Different influential parameters, however, can be classified in three general categories with respect to their nature and origin:

- Voltage related parameters
 - Pre-dip parameters:
 - Magnitude of supply voltage, voltage distortion, etc.
 - During-dip parameters
 - Dip type (Type I, II or III, see Chapter 2), dip duration, dip magnitude, dip shape, points on wave of dip initiation/ending, phase shift, etc.
 - Post-dip parameters
 - Slow recovery of the supply voltage due to high inrush currents drawn at the end of dip event and re-energising of equipment, voltage distortion, etc.
 - Network topology
 - Source impedance at equipment terminals
 - Presence of other equipment at the same or parallel supply lines/feeders.
- Equipment specific parameters
 - Hardware specifications
 - Operating mode: parameter setting of the equipment, protection settings
 - Load type: load current or voltage, load speed, load torque, mechanical inertia, etc.
- Non-electrical parameters: temperature, humidity, altitude, presence of vibrations, etc.

It can be concluded from the above list that, depending on the nature of the equipment and the number of parameters to be considered, it is not possible to represent the impact of all dips with a simple (e.g. single voltage-tolerance curve) representation. In this chapter, the emphasis is on the main parameters that may impact equipment behaviour.

The knowledge on this is based on the available literature and on the actual experience of the working group members.

The following sections describe the behaviour and typical responses of contactors, direct on-line induction machines, ASDs, thyristor-controlled rectifiers, PLC's and PC's to voltage dips. The presented results are obtained either in extensive laboratory tests of a limited number of devices per equipment type, or using computer simulations, which are validated with actual measurements. For each equipment type, the list of the parameters known to have an impact on equipment behaviour is also provided.

It should be noted that published results may not be generally applicable, as each individual equipment, together with its environment and application-specific parameters, exhibits its own and unique characteristics.

3.2.1 Contactors

Electromechanical relays and contactors are used to power and control loads. References to "contactors" in this section apply equally to electromechanical relays. After a supply interruption, a motor contactor may also act as a safety device, to prevent the uncontrolled restarting of the motor. Due to a voltage dip, contactors can disconnect loads unintentionally, resulting in process interruptions or in unsafe situations. The safety function of contactors and relays should always be kept in mind, even if this results in reduced voltage dip immunity.

Although they may switch single-phase or three-phase equipment, contactors themselves are normally connected as single-phase devices. The single-phase supply is connected to the magnetising coil of the contactor. Depending on the design, this can be an ac or dc coil. Applying voltage to the coil results in a magnetic flux, which in turn creates a force that closes the contacts. After disengaging the control voltage, the flux vanishes and a spring opens the contacts¹. Contactors are identified as a weak link in many processes during voltage dips [3], [4], [5], [6], [7], [30].

¹ The higher the source impedance of the supply, the slower the flux will decrease. So far, accurate information of the actual impact of the source impedance on the contactor dip behaviour is not reported and remains as a research topic.

Figure 3-1 shows typical voltage tolerance curves for a contactor obtained in laboratory tests. The area above the curves indicates normal operation of the contactor (pass). Dips with magnitudes and durations below the curve result in malfunctioning of the contactor (fail). Apart from magnitude and duration of the voltage dip, the point-on-wave of dip initiation also influences the contactor behaviour, Figure 3-1 a) and b), [3], [4], [5]. This can be explained from the energy stored in the magnetic circuit. The stronger the magnetic field at the moment of dip initiation, the more easily the contactor rides through the dip. For short duration voltage dips, due to the lagging power factor of the inductive contactor coil, contactors are most sensitive to dips initiated at 90° and least sensitive to dips initiated at 0° , where 0° corresponds to the upward voltage waveform zero crossing.

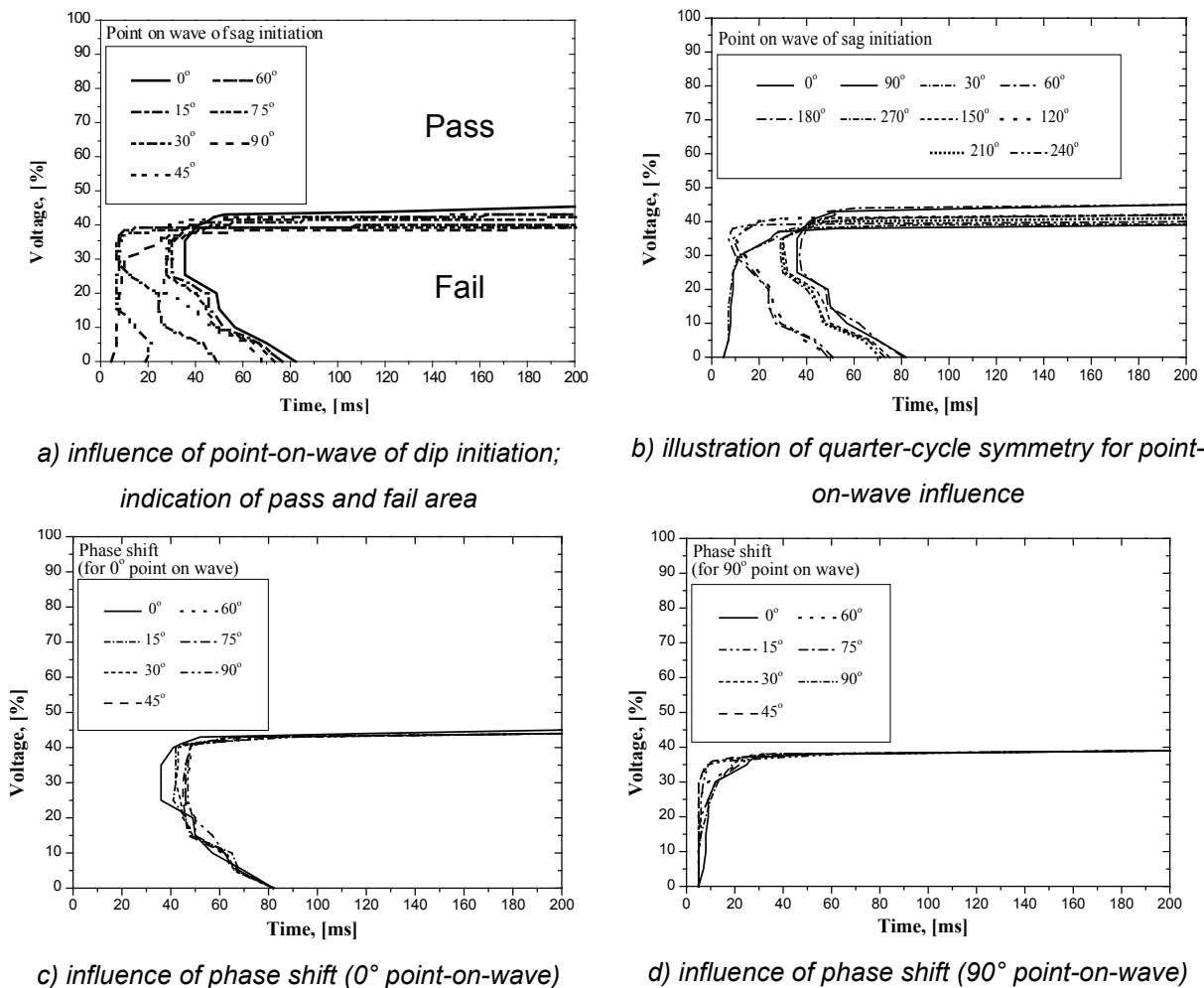

Figure 3-1 The influence of dip parameters on contactor sensitivity identified in laboratory tests: a) and b) point-on-wave of dip initiation, c) and d) during-dip phase shift [5].

For long duration voltage dips, the horizontal part of the tolerance curve for 0° point-on-wave is higher for about 5-10% than 90° point-on-wave curve. Figure 3-1 c) and d)

illustrate the impact of the phase shift (phase-angle-jump) on the contactor behaviour ([5]), which has less influence than the point-on-wave of dip initiation.

Figure 3-1 shows contactor behaviour based on laboratory testing, but the same behaviour can also be generated through simulation. Accurate models for ac contactors are reported in literature, and can be developed with reasonable effort [4], [7]. Figure 3-2 gives simulation results with point-on-wave as a parameter (0° and 90° points-on-wave). The simulation models allow good understanding of the tripping mechanisms of the contactor, because all physical variables can be easily controlled and analysed.

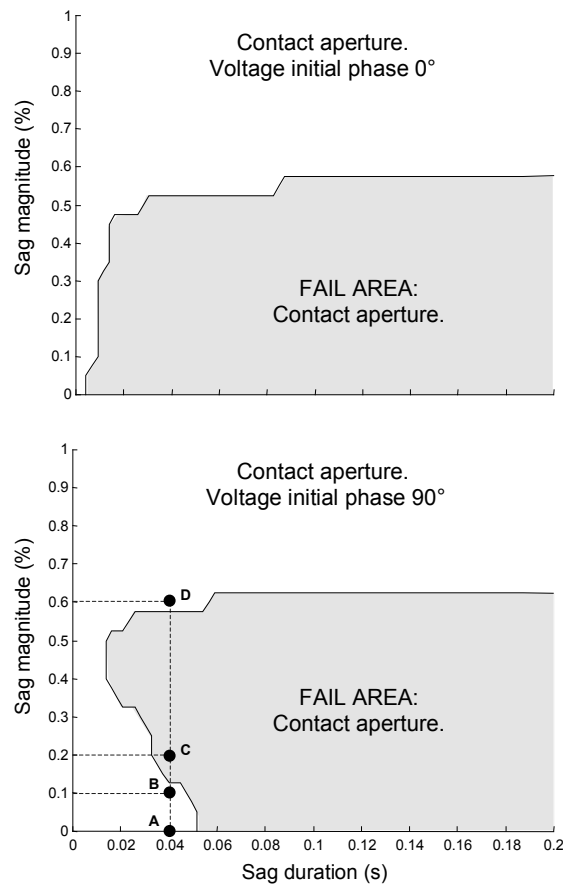

Figure 3-2 Simulation results: impact of point-on-wave on contactor behaviour [7].

The sequence of voltages in a non-rectangular dip can also influence how an ac coil contactor responds, as illustrated in Figure 3-3. Two two-stage voltage disturbances are generated, each having the same parameters of the individual stages, but different order of stages. The first disturbance is characterised by an initial short interruption (drop to zero voltage magnitude) and subsequent dip to 35% of nominal voltage, both with 30-ms duration (Figure 3-3a). This disturbance yields malfunction of the equipment (i.e.,

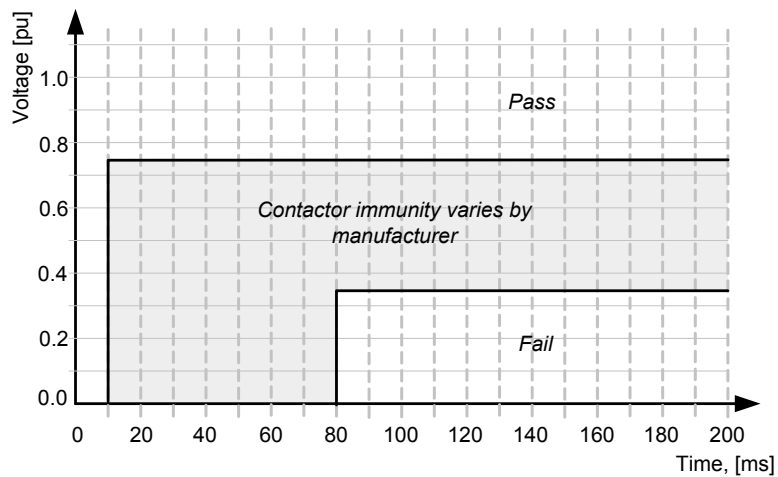

Figure 3-4 Best case and worst case voltage-tolerance curves for ac-coil contactors from different manufacturers.

Voltage dip immunity can be improved if a dc control voltage is used instead of ac control voltage. The ac supply voltage is rectified and then flattened by means of a capacitor. The use of a capacitor results in a certain amount of energy storage. During a dip, this energy is used to keep the contactor closed. Figure 3-5 shows the voltage tolerance curve for a contactor with dc control voltage. Compared to a contactor with ac control voltage, the immunity for short interruptions and deep voltage dips increases drastically. Furthermore, the impact of point-on-wave on the tolerance curve can be neglected.

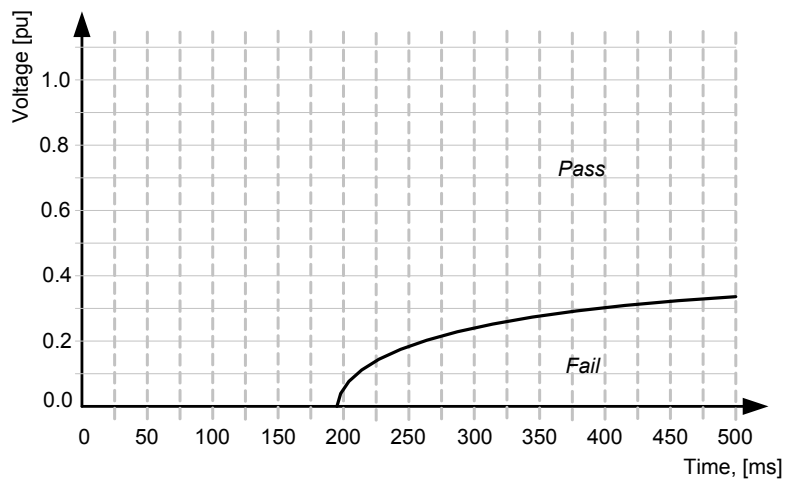

Figure 3-5 Voltage tolerance curve for a contactor with dc control voltage coil.

3.2.2 Direct on-line induction motors

Most motors in industry are still direct on-line induction motors (DOL IM), usually used in applications with constant speeds. A voltage dip at the terminals of a direct on-line induction motor results in speed loss, current and torque fluctuations, and possible

activation of protective devices, such as fuses, circuit breakers, or dedicated motor protection devices [8]-[15].

First, the behaviour of a three-phase DOL motor exposed to a Type III dips (with all three phase-to-phase voltages equally reduced) is discussed. At voltage dip initiation, the motor speed starts to decay, because the developed torque is proportional to the square of the supply voltage. Figure 3-6 shows the torque-speed motor characteristics before and during a voltage dip, for motor operating in a constant load torque application (horizontal line). The intersection between the two motor curves and the load curve are stable operating points. During the voltage dip the motor speed decays from ω_{nom} to ω_{dip} . The time it takes motor to reach this new steady state depends on the system inertia and applied load torque (Figure 3-7). The higher the inertia and the lower the mechanical load, the slower is the decay. The motor current shows a transient, before increasing with the same rate as the speed reduction. The transient is caused by the contribution to the fault of the motor due to the flux decay [11]. If the load torque exceeds the maximum motor torque for the reduced voltage, the motor stalls.

At voltage recovery, the motor will reaccelerate and may draw higher currents than the starting current, [14]. If a large motor has to recover, or if a process or plant contains many direct on-line induction motors, the cumulative effect of the reacceleration of all motors will cause an additional voltage drop (post-fault voltage dip), additionally influenced by the source impedance (Figure 2-3, chapter 2). As a result, the available torque is reduced and the acceleration time increases. This can stress the supply system with the consequent activation of protective equipment in the system, or it can be misinterpreted by the motor protection as the locked rotor situation and lead to a disconnection of the motor, [8]. Depending on the dip magnitude, dip duration, source impedance and loading conditions, the motor speed may or may not reach the pre-dip value after voltage recovery. For a given load and source impedance, a dip magnitude and dip duration can be identified beyond which speed recovery is no longer possible.

One strategy that avoids induction motors stalling at voltage recovery consists of disconnecting the motors as soon as the voltage dip is detected. Immediately after voltage recovery, a controlled motor restarting procedure is then activated (e.g. by starting the

motors sequentially and/or in groups, beginning with the most critical ones for the process), avoiding a system-wide large starting currents.

If a motor is restarted before the flux of the machine has disappeared, high transient shaft torques have been reported to cause damage to the mechanical load driven by the motor [15]. The disappearance of the flux may take up to several hundred milliseconds in open circuit.

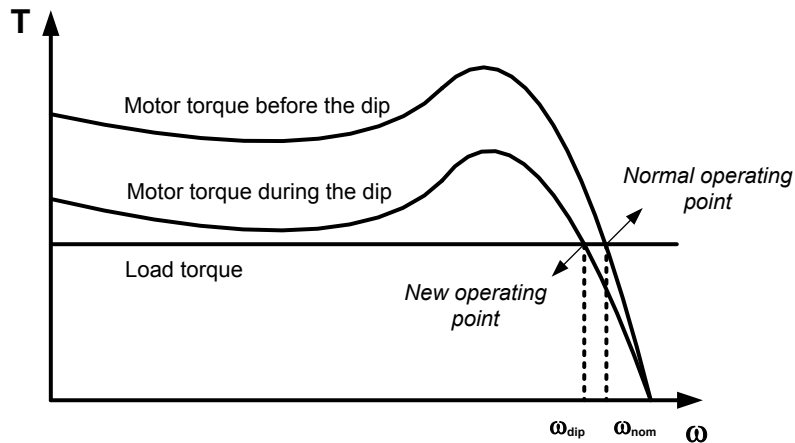

Figure 3-6 Torque – speed curves for a direct on line induction machine under normal and reduced voltage (voltage dip) conditions.

Type I and II (unbalanced) dips applied to three-phase on-line induction motors also result in speed loss and current and torque fluctuations [11]. Current and torque peaks depend on point-on-wave of dip initiation. The torque is oscillatory during the dip, which is not the case for a balanced dip [12]. The speed reduction is typically less pronounced, compared to balanced Type III dips (Figure 3-8).

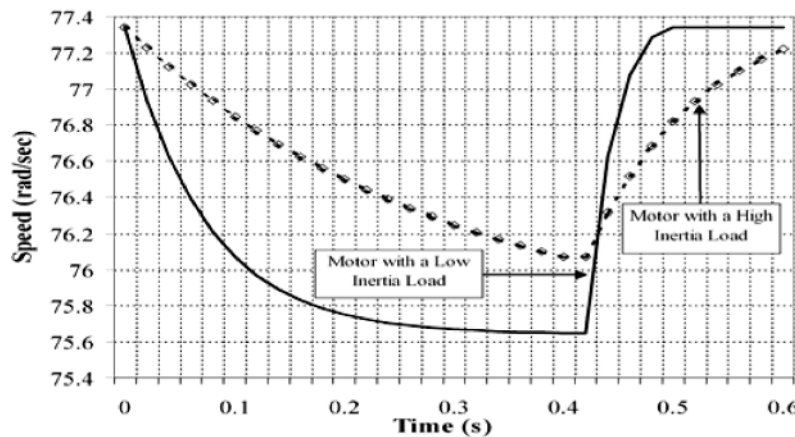

Figure 3-7 DOL IM speed change with respect to high and low load inertia [10].

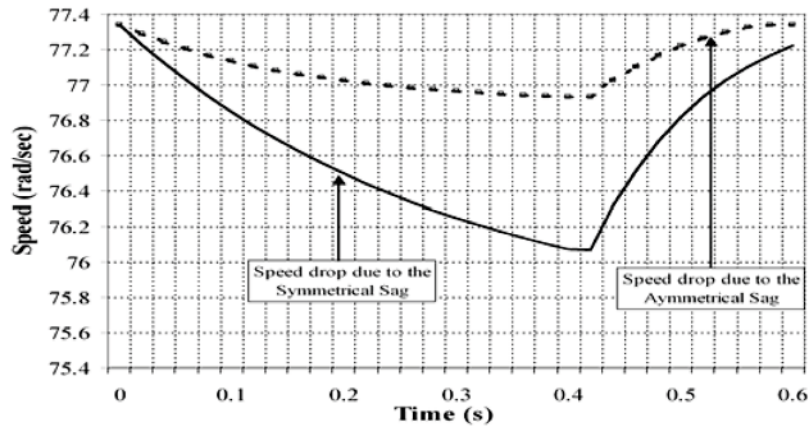

Figure 3-8 DOL IM speed change with respect to balanced (Type III) and unbalanced dips [10].

3.2.3 Adjustable speed drives

Adjustable speed drives³ are used to improve process control, to save energy, or to avoid mechanical stress in installations. An ASD controls the torque or speed of an induction motor, or a synchronous permanent magnet motor, by converting the fixed frequency supply voltage to a variable frequency and variable voltage magnitude at the motor terminals. The ASD is a power electronic converter, typically consisting of a diode rectifier, a dc bus with dc capacitor(s) and an IGBT-inverter (Figure 3-9). The diode rectifier charges the dc bus capacitors, which, apart from filtering/smoothing the ripple on the dc voltage, also act as an energy buffer that can be used to maintain operation under voltage dips conditions. A pulse-width modulated inverter converts the dc bus voltage to the desired motor supply voltage. Starting from the power ratings of about 1.5 kW, ASDs are usually connected to a three-phase supply.

The dip behaviour of an ASD depends on the hardware topology, the control algorithm and loading conditions. Furthermore, a distinction has to be made between the behaviour for Type III dips and Type I and Type II dips [18]-[23], [25], [26].

³ “Adjustable speed drives” are also referred to as “power drive systems” or “variable speed/frequency drives”.

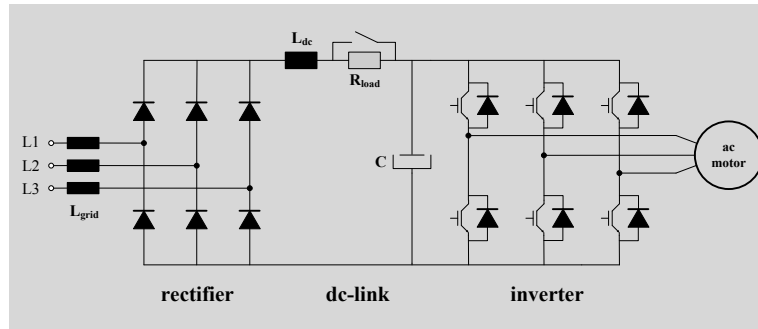

Figure 3-9 Hardware topology of an adjustable speed drive with passive front-end diode rectifier.

Type III (balanced) dips and three-phase Adjustable Speed Drives

Figure 3-10 shows the voltage tolerance curve of a three-phase ASD with open loop “scalar” Volt/Hertz control for a Type III (balanced) dips. After voltage dip initiation, the dc bus capacitors discharge as long as the supply voltage magnitude is lower than the dc bus voltage U_{dc} . The rate of voltage decay of the dc bus voltage depends on the loading conditions of the controlled motor. If U_{dc} drops below the undervoltage protection setting, this will trip the drive. The undervoltage protection is mainly activated for interruptions and voltage dips with low remaining voltage. The undervoltage protection value $U_{dc\ min}$ ranges from about 85% to 60% of the nominal value, depending on the hardware topology and software settings of the drive. In some cases, this value can be set by user⁴.

For dips with high remaining voltage and long duration, the motor overcurrent protection may be activated at voltage recovery. For an ASD with simple Volt/Hertz control, the reduction of U_{dc} due to a dip is not compensated for, and, as a result, the applied motor voltage is reduced and motor develops lower torque. If the ASD is used in open loop, the motor speed will not be corrected. At the conclusion of the dip, the supply voltage recovers and dc bus capacitor recharge and draws a high current. This high charging current can activate line current protection, or even damage the rectifier components. On the motor side, this causes a high reacceleration current in the motor, similar to the reaction of a DOL motor after a dip. The acceleration current may activate the motor overcurrent protection in the ASD. This motor overcurrent phenomenon can be avoided by using a field oriented control scheme, which can detect and correct for the reduced U_{dc} and is fast

⁴ The user is recommended to contact the manufacturer before any change in protection settings is made.

enough to limit the motor currents to avoid tripping of the drive due to motor overcurrents. If closed loop control is used, the ASD can correct for the speed reduction by increasing the frequency of the applied motor voltage, as long as the available torque is higher than the load torque [21].

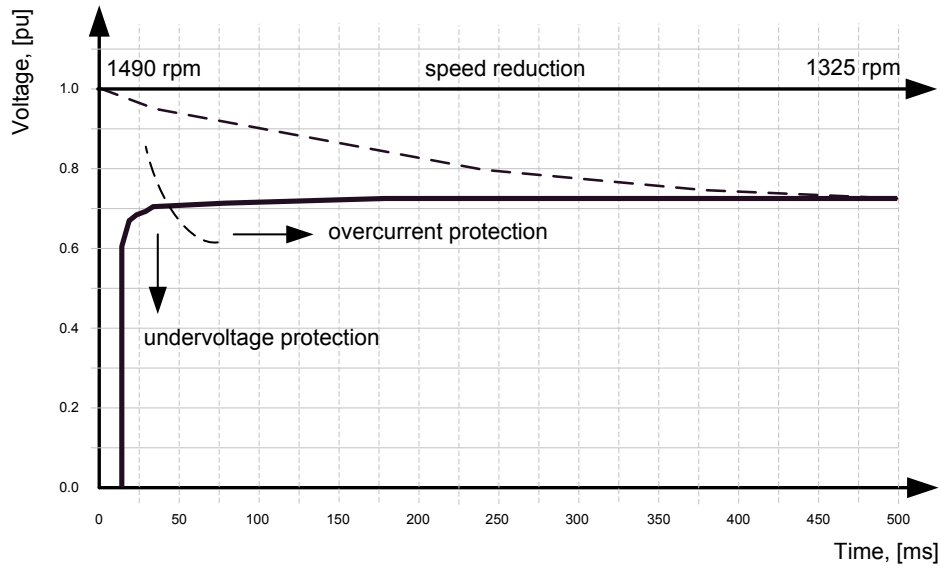

Figure 3-10 Voltage tolerance curve and speed reduction (dashed line) for an open loop Volt/Hertz-controlled ASD subjected to Type III (balanced) dips.

Figure 3-11 shows that the mechanical loading of the motor has a significant impact on the immunity of an ASD [21]. Generally, a reduction of the load will improve drive immunity, with both the horizontal and vertical parts of the voltage-tolerance curve affected. As the load decreases, the energy required by the motor during the dip will also decrease. Accordingly, the dc bus voltage decay is slower, and it takes longer to reach the undervoltage protection value $U_{dc \text{ min}}$. Consequently, the vertical line of the voltage-tolerance curve shifts to the right. The voltage values indicated in the voltage-tolerance curves show the rms supply voltage. In contrast, the activation of the undervoltage protection is based on the pre-dip dc bus voltage $U_{dc \text{ dip}}$. As the load decreases, the ripple on U_{dc} also decreases and the horizontal line of the tolerance curve approaches the undervoltage value. The time to trip t_{trip} depends on the load conditions, the pre-dip voltage and the undervoltage settings. It can be approximated by:

$$t_{trip} = \frac{C(U_{dc \text{ pre}}^2 - U_{dc \text{ min}}^2)}{2P}$$

where C is the dc bus capacitance and P is the electric power required to drive the load.

Figure 3-12 shows the impact of different load profiles and different motor speeds on the voltage-tolerance curves, again illustrating the variations in ASD dip immunity due to different equipment specific factors.

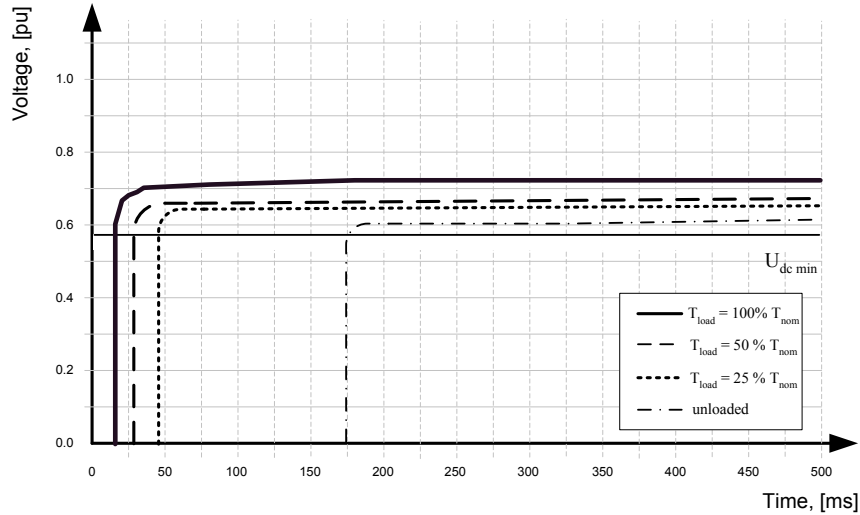

Figure 3-11 Impact of different loading conditions on the immunity of an ASD to a balanced voltage dips [21].

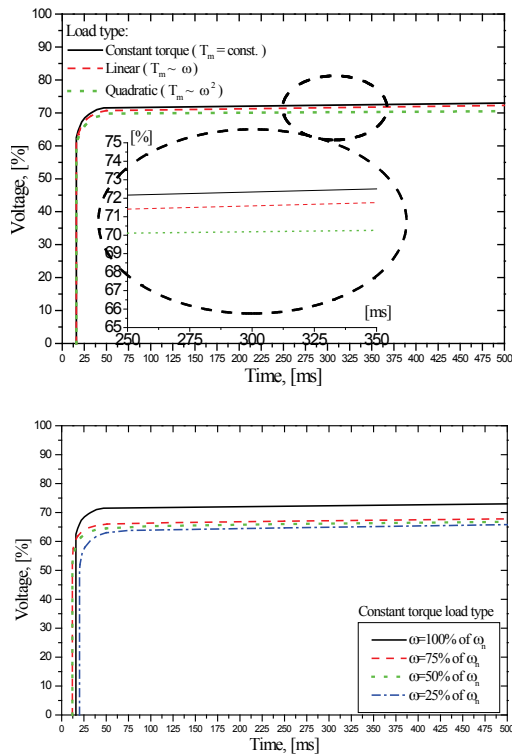

Figure 3-12 Impact of load types and different motor speeds on the immunity of an ASD to balanced dips [21].

Some drive manufacturers allow the reduction of the undervoltage protection level $U_{dc\ min}$, in order to improve ride-through capability of the drive for both balanced and unbalanced dips. When doing so, extra line chokes/inductances may be required to limit the charging currents at voltage recovery (i.e. at the end of the dip). Figure 3-13 shows simulation results for an ASD subjected to a Type III dip and for a 1% and 5% line choke⁵. Before the dip, the dc bus voltage for an ASD with 5% line choke is lower than for a drive with 1% line choke. Adding line inductance, therefore, reduces the energy stored in the dc bus capacitors. At voltage recovery, a lower value of source impedance (1% line choke) results in higher charging currents and higher stress of the rectifier components. Increasing the line choke value reduces the amplitude of these charging currents, and helps in obtaining more reliable operation of the rectifier. Some drive manufacturers integrate the chokes between the diodes and the capacitors. For most drives, however, additional chokes must be placed in front of the rectifier.

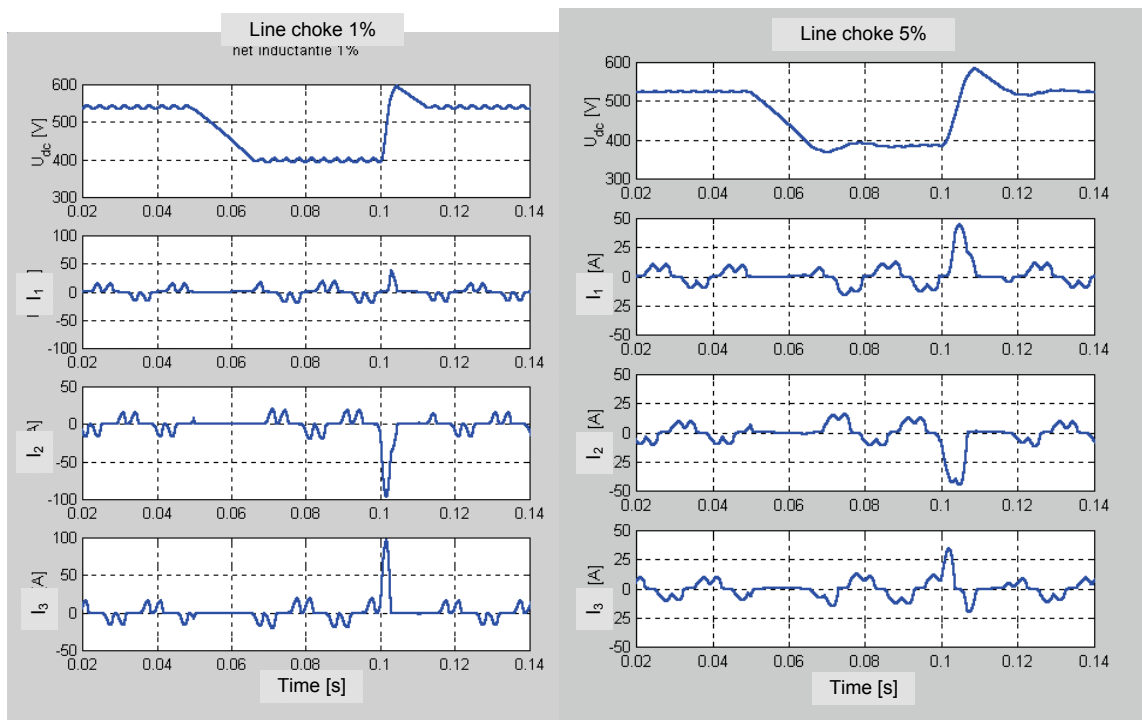

Figure 3-13 The dc bus voltage and line currents for an ASD with different values of line choke/inductor subjected to a Type III dip.

⁵ A 5% line choke has an impedance of 0.05 pu, with the rated power and voltage of the drive selected as a base values. [Note: The original statement is only correct in steady state, when the current is purely reactive and the choke is purely inductive.]

Unbalanced dips and three-phase Adjustable Speed Drives

For Type I and II dips, the analysis of the drive behaviour is more complicated. Depending on the during-dip voltages, the rectifier may be able to charge the dc link capacitors. For a Type I dip, with drop in magnitude in only one of the phase-to-neutral voltages, the three-phase rectifier will act as a single-phase rectifier. The dc link is charged at twice the supply frequency. The dc voltage ripple increases and different powers/currents flow through six diodes of a full-bridge rectifier, [26]. If the dc voltage does not drop below $U_{dc\ min}$, the ASD can ride-through this dip. If no overcurrent protection is activated, the behaviour is dictated by the value of the dc bus capacitor C and $U_{dc\ min}$. Under these conditions, although the undervoltage protection is not activated, some drives still trip due to the phase-loss protection, which is typically activated after several 100ms. Figure 3-14 gives the required dc bus capacitor value C for a given undervoltage protection level $U_{dc\ min}$. Points marked with crosses in the figure represent actual values for some commercial drives in the power range up to 7.5 kW, [25]. If the pre-dip dc bus voltage is equal to the nominal value U_{nom} , 50% of the tested drives are capable to ride-through any Type I dip. If, however, the pre-dip voltage is lower, for example $0.9U_{nom}$, all drives will trip due to a Type I dip. A similar analysis can be found in [26]. What matters for the performance of ASD is not the rms value of the pre-dip voltage but its peak value. The distortion of the pre-dip voltage, therefore, also impacts the ASD dip immunity. In [20], the impact of a pre-dip voltage distortion with total harmonic distortion THD = 3.5%, resulting in a reduced pre-dip voltage magnitude, is simulated. The resulting voltage-tolerance curve (Figure 3-15) shows that the device is less immune. In [21], measurements on a drive confirmed this conclusion.

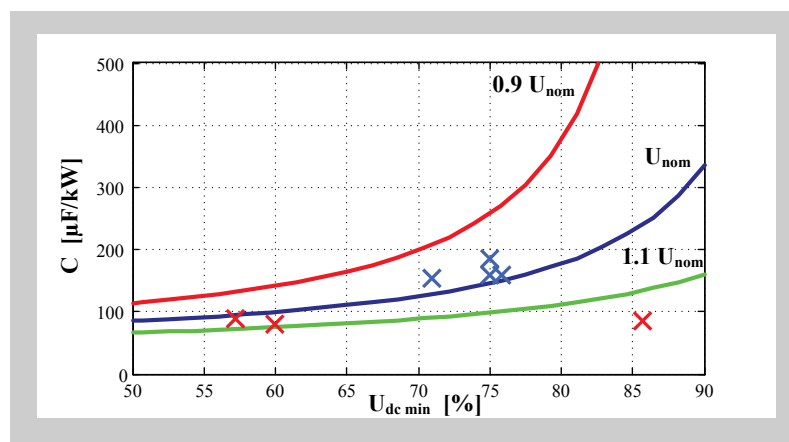

Figure 3-14 Required dc bus capacitor value C for a given undervoltage protection level $U_{dc\ min}$ for a Type I dips (with reduction in one phase-to-neutral voltage); points marked with crosses are found in commercial drives [25].

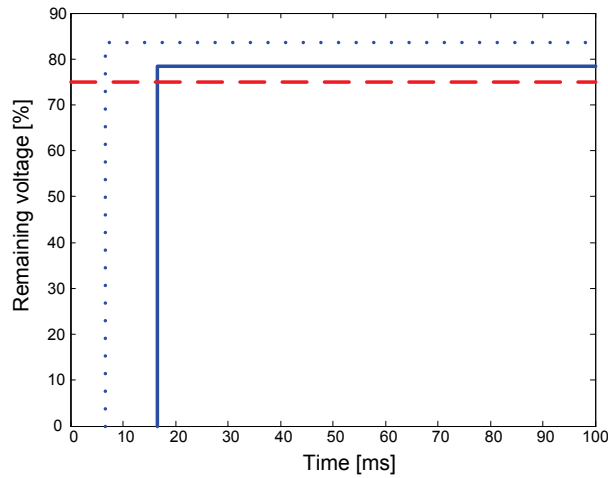

Figure 3. 15 Simulated voltage-tolerance curves for both sinusoidal (solid line) and non sinusoidal pre-dip supply voltage with a total harmonic distortion THD = 3.5% (dotted line) with reduced pre-dip voltage magnitude.

Under unbalanced dip conditions, all power is transported via the phase with the highest remaining voltage. This results in increased currents. Depending on the source impedance, this can result in additional voltage reduction at the equipment terminals. Figure 3-16 and Figure 3-17 show the measured voltage tolerance curves illustrating the impact of unbalanced dips on an ASD. In Figure 3-16, curves for an unbalanced dip with a strong reduction in one phase-to-neutral voltage are given. As an additional parameter, the magnitude of the other two phase-to-neutral voltages is varied, resulting in a less immune drive. Figure 3-17 shows the results for an unbalanced dip with a strong reduction in two phase-to-neutral voltages with the variation of the third voltage magnitude as additional parameter.

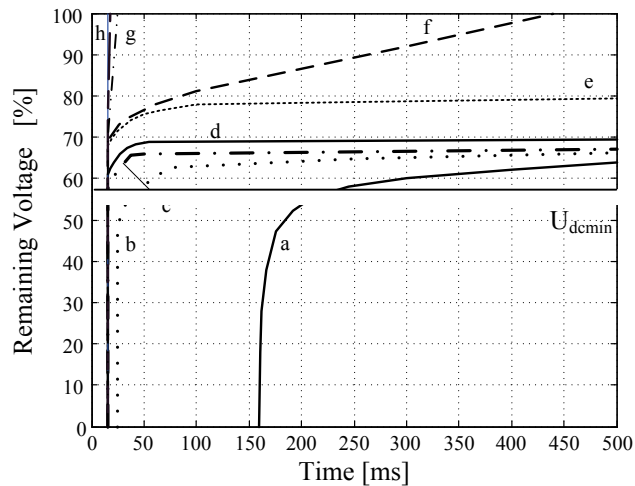

Figure 3-16 Voltage-tolerance curves of ASD for Type I unbalanced dips (with reduction in one phase-to-neutral voltage); voltage in two other phases: a-100%; b- 90%, c-80%, d-75%; e-70%, f-65%, g-60%, h-50%, [21].

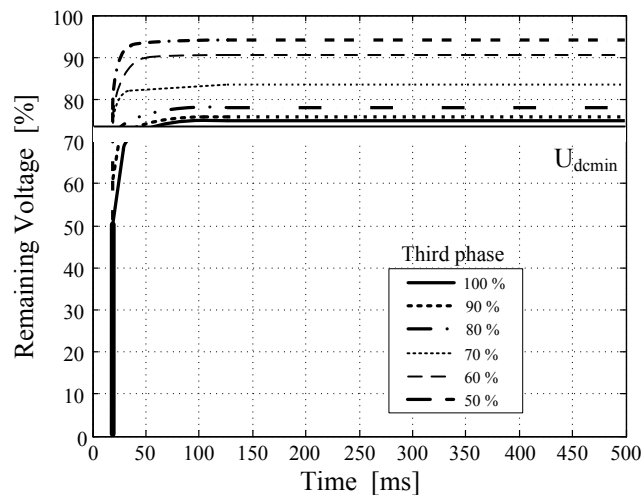

Figure 3-17 Voltage-tolerance curves of ASD for Type II unbalanced dip (with reduction in two phase-to-neutral voltages); voltage in the third phase is additional parameter, [21].

Depending on the process requirements, the sensitivity of the ASD can be improved by implementing inertia ride-through (also known as “kinetic buffering”), [22]. If a speed reduction in the process can be tolerated, the drive with this option enabled will attempt to maintain the dc bus voltage at a certain level during the dip by regenerating power from the load. Regeneration is started when the dc bus voltage drops below the activation level U_{KIB} . High load inertia and increased tolerance for speed reduction both improves dip immunity. Figure 3-18 shows the impact of kinetic buffering on a 4 kW ASD with large inertia compared to the voltage-tolerance curve without kinetic buffering (dashed line). If a

process contains several ASDs, the use of a common dc bus for all drives can further improve the overall ride-through capabilities of the drives and the process.

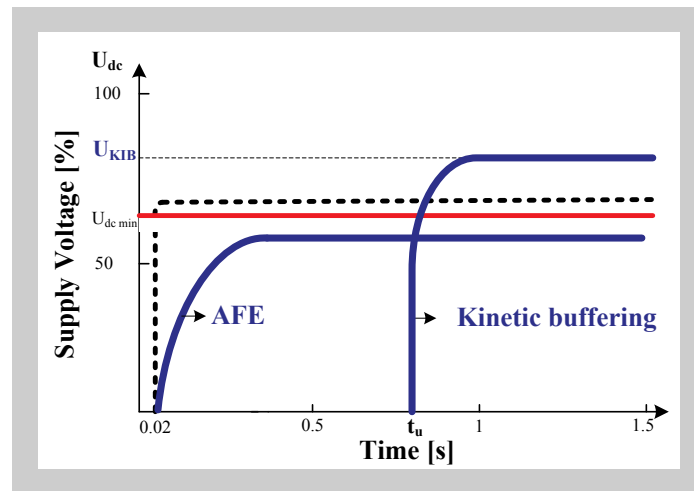

Figure 3-18 Voltage-tolerance curves for a 4 kW ASD with large inertia, and with/without (dashed line) kinetic buffering, and with active front end (AFE) IGBT rectifier. Kinetic buffering activation level U_{KIB} is set at 80% .

The ASDs can also be equipped with an active front end (AFE) IGBT rectifier [24], [22]. This results in sinusoidal line currents and the ability to regenerate energy to the supply. The drive is energised as a passive diode rectifier, and then the IGBTs are enabled and the dc bus voltage is regulated to a value higher than the peak of the ac line voltage. During a voltage dip, the rectifier regulates the dc bus voltage as long as the ac line currents are below the current limit of the rectifier. A typical voltage-tolerance curve is given in Figure 3-18. Rectifier current overload or loss of synchronisation can trip the ASD [22]. If a synchronisation fault occurs, the IGBT gate pulses are disabled. The rectifier now acts as a passive diode rectifier until synchronisation is re-established.

When the ASD trips due to a voltage dip, the motor is released from the control and allowed to freely spin. After the end of the dip and recovery of supply voltage, the drive can be activated/connected either manually or automatically. If the motor is still spinning, a “flying restart” option is required to immediately re-establish drive control of the motor. When activated, the restart procedure detects the actual motor speed in order to synchronise the drive to this speed and to accelerate the motor to desired (e.g. pre-dip) speed. If no speed sensors are available, this speed detection procedure can take from several ms to several seconds, depending on the applied control strategy in the ASD. This

method is extremely useful for automatic restarting of remote ASDs without manual intervention.

3.2.4 Thyristor controlled devices

Thyristor controlled devices such as dc motor drives and rectifier units usually use a phase-locked-loop (PLL) circuit to synchronise operation of the thyristors to the ac supply voltage. Typical PLL circuits require a few system cycles/periods to stabilise, after a voltage dip. Especially when thyristor devices are used in generation mode, voltage dips with phase angle jumps often result in uncontrollably high rectifier currents. These currents can blow the special semiconductor fuses or can damage the power electronic components themselves [17].

IGBT rectifiers are less sensitive to voltage dips than thyristor rectifiers, because the dc bus voltage is regulated by closed loop control. If a line synchronisation fault occurs during a dip, the freewheeling diodes in the IGBT rectifier provide a conduction path and can prevent tripping.

3.2.5 Programmable logic controllers

Programmable Logic Controllers (PLCs) are used to control industrial processes. Malfunctioning of a PLC will therefore almost always result in process tripping, or unsafe process conditions [31]-[33]. A typical PLC includes a power supply, Central Processing Unit (CPU), as well as digital and analogue input/output (I/O) modules. The inputs are processed by the software program in the CPU, generating appropriate output signals to control the process. A discussion of each of these parts, as well as the power quality considerations, is given in the next sections.

PLC I/O Power Supply. A PLC power supply uses a typical switch-mode power supply topology. Although available for both ac and dc input power sources, the most commonly used units utilise an ac input source of 120V or 230V ac. The purpose of the unit is to supply dc power to all devices physically mounted on the I/O rack backplane of the PLC. These devices may include the PLC CPU and communications module(s), as well as discrete and analogue I/O modules. The power output of the supply depends on the number and type of I/O modules connected. It is important to note that, typically, the PLC power supply does not provide power to field devices, such as sensors, transmitters, motor starters, and solenoids.

Because of the serious consequences that might result from a malfunctioning PLC system, most PLC power supplies perform continuous diagnostics. The protection of the PLC is constantly monitoring either the input ac voltage, or the power supply's dc voltage output, in order to decide when to shutdown during the voltage dip events. If a serious problem is detected, the power supply will notify the CPU to halt program execution, in order to shut down process operations in a controllable way. Figure 3-19 displays the general topology of a PLC power supply.

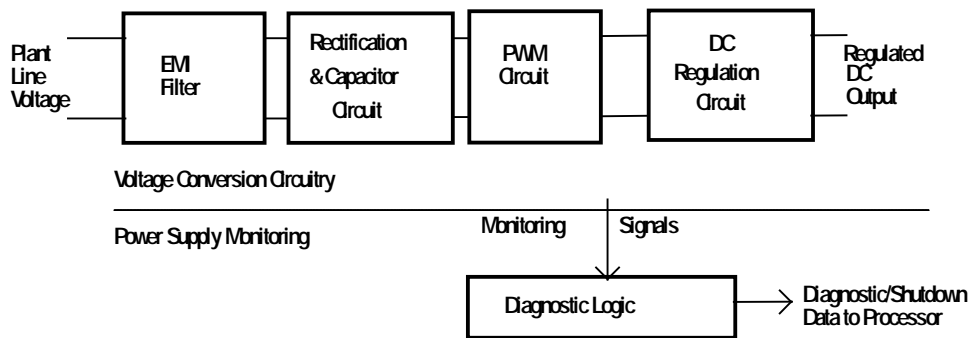

Figure 3-19 Typical PLC power supply topology.

If the input ac voltage is monitored, PLCs will usually react to voltage dips as short as 1 cycle in duration, which may be inappropriately fast if the PLC function can be maintained for a longer time by simply using the energy stored in the power supply's dc bus capacitors. In contrast, if the dc output voltage is monitored, reaction on the voltage dip is retarded, as the energy stored in the dc bus capacitor(s) will maintain the dc output voltage, and improve overall PLC dip immunity. An example of voltage tolerance curves obtained in testing PLC power supply is shown in Figure 3-20, illustrating different behaviour depending on the implemented protection strategy and hardware topology.

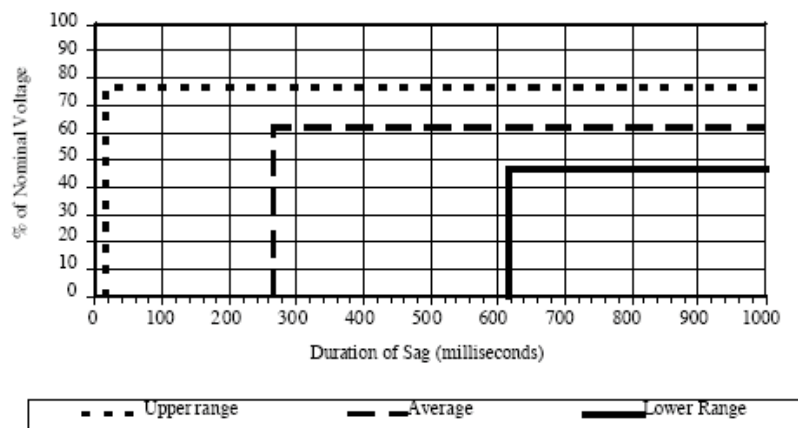

Figure 3-20 Upper and lower range of voltage dip tolerance curves for PLC power supply [28].

Input/Output modules. The Input/Output modules can be grouped into digital and analogue modules. *Digital input modules* are usually used to connect external sensors, such as proximity switches, pushbuttons, etc. The susceptibility of the digital inputs to voltage dips is only relevant if the PLC power supply has not already led to a system shutdown (this especially holds for PLCs that monitor the dc voltage). Digital inputs are designed to react quickly to detect a change in the input signal. As a result, they will also react quickly to changes in the digital input values caused by voltage dips, and control system may misinterpret an “on” condition to actually be an “off” condition. Such false negative conditions from a process sensor can lead to the malfunction or immediate shutdown of the process.

In the case of *ac input modules*, the voltage dip immediately passes to the input terminals of the module. In the case of dc discrete input modules, the external dc power supply can mitigate effects of a voltage dip, and provided output power to the sensors may not be affected. The ability of the dc power supply to provide this “embedded” mitigation to voltage dips is generally dependent on the topology, size of the dc bus capacitors, actual loading, and input voltage. If the dc power supply is unregulated, less energy will be present to mitigate the voltage dip (only available energy is in the dc bus capacitors). It can be generally concluded that if the power supply design is more robust, the input sensor signals will also be more robust to voltage dips.

Discrete Output modules are available as ac or dc types, and are used to switch the on/off voltage signal to field devices, such as motor starters, relays, solenoids, and pilot lights.

The susceptibility of the discrete output module is directly related to the PLC power supply shutdown signal, as well as to the susceptibility of the individual loads connected to the module. Since the discrete output module simply acts as a switch to the individual loads, it has little ability to affect the voltage dip response of the system. If the PLC decides to shut down as a result of a voltage dip, all discrete output signals typically will drop, unless they are specially configured on the I/O rack. Most end-users do not opt to allow the outputs to stay powered in this state, since such conditions may lead to safety and machine damage issues.

Even when PLC power supply is immune to voltage dips, but field devices (e.g. motor starters and relays) are not, the process may still malfunction or shut down. To ensure that all outputs have good dip immunity, the most comprehensive approach is to ensure that the control power voltage source is robust. The system integrator can do this by conditioning the power source in an ac system, or by using a robust dc power supply and dc output module which, in turn, would require the use of dc-powered field devices.

Analogue input modules receive a continuous dc current or voltage signal from the process transmitters (typically 4-20 mA, 1-5 V, or 0-10 V). DC power supplies are required to source the voltage or current loops for the analogue input signals. Therefore, the voltage dip susceptibility of the analogue input module and the process transmitters is related to the ability of the external dc power supply to ride-through the voltage dips. Typical voltage tolerance curves are given in **Fel! Hittar inte referenskölla**. Two basic configurations for process transmitters are known as “two-wire” and “four-wire,” each of which leads to power quality considerations. A “two-wire” process transmitter is powered by an external dc power supply, which may also provide dc power for all transmitters in the system. With a single source of dc power, the analogue input signals can be made robust to voltage dips if the dc power supply is robust. With the “four-wire” transmitter topology, an external ac voltage source is needed to power the transmitter. In this configuration, the transmitter provides the continuous dc signal to the individual channel on the analogue input card. In this case, the required dc power supply is located within the transmitter itself. For these reasons, voltage dip immunity should be checked for each of the “four-wire” transmitters in the process.

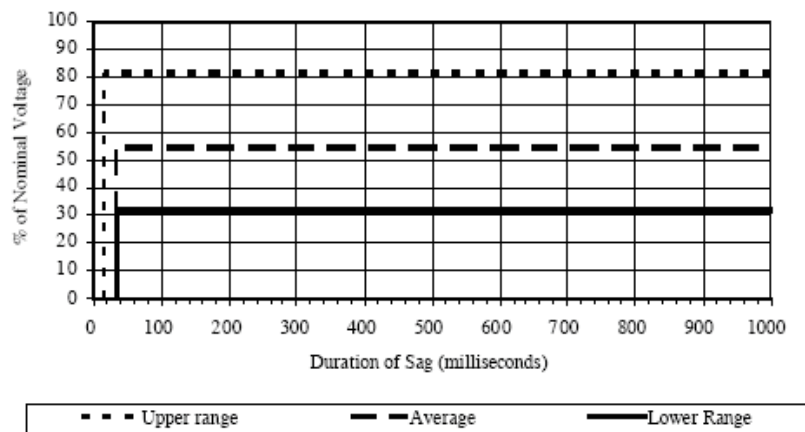

Figure 3-21 PLC ac input card voltage tolerance curves [28].

Analogue output modules provide a continuous dc voltage/current signal to field devices (used for e.g. control of the position of a proportional valve, or speed control of a motor). Depending on the manufacturer and module type, analogue output signals can be sourced by the PLC power supply through the I/O rack back plane, or by an external dc supply. Therefore, the stability of the output signal to the field device is dependent on the robustness of the actual dc voltage source. Tests have indicated that, when sourced by the PLC power supply, the PLC will normally shut down before the dc output voltage and integrity of the control signal is affected. When the PLC shutdown occurs, the analogue signal is removed from the field device, which will directly affect the controlling signal (position of a valve or the speed of a motor). In the case where an external dc power supply is required to source the analogue output current loop, the robustness of the power supply to voltage dips may directly affect the control of the process.

Central Processing Unit (CPU). The CPU reads the input data, solves the control program, and updates the output. The CPU receives operating power through the I/O rack back plane via the rack's power supply. A lithium battery and/or Electrically Erasable Programmable Read Only Memory (EEPROM) are typically used to maintain the PLC program in the event of loss of power. Due to a dip, false input data from disturbed sensors can be processed by the CPU, resulting in incorrect output actions, or even shutting down the process.

Using appropriate programming techniques can help to reduce the impact of a voltage dip on the PLC and the process it is taking care off. For example, in process applications, the

process step of a batch may be held in the PLCs volatile memory. If the PLC experiences a shutdown and restart as a result of a voltage dip, the process state of the batch will likely be cleared, since the volatile memory is erased. This may lead to the loss of the batch. A better technique is to write process step information into non-volatile memory areas that are not cleared when the PLC shuts down and restarts. By placing a process step number into a non-volatile memory location, the PLC can then, with the proper coding, know where to resume the process operations. This approach, which is known as the state-machine method, can be of significant help for restarting control system when a voltage dip or outage-related upset occurs. In some voltage-dip immunity designs, the CPU receives a digital signal (or contact of some relay closes), indicating that a dip is in progress. This signal can activate alternative programme or code, specifically written to recover the whole process automatically after the dip ends and voltage supply recovers. More practical guidelines to help integrators and users of PLC-based systems to make proactive changes in design and to improve voltage dip response can be found in [31] and [32].

3.2.6 Personal Computers

Personal computers (PCs) are often a crucial part in many processes, especially when used for real-time control and communication purposes. Usually, they are powered by an ac/dc converter, which converts ac supply to a stable dc supply. The ac voltage is rectified by means of a diode rectifier, and a dc bus capacitor is used for reducing the ripple of the rectified voltage. Under normal operation, the capacitor contains energy that can be used during a voltage dip. The rectifier stage is followed by a switched-mode regulator, which provides stable low voltage dc supply, and power factor correction circuit, which regulate input current to be sinusoidal in shape and in phase with input voltage. Most PCs are designed to operate on 230V/50Hz and/or 120V/60Hz supply systems.

When subjected to a voltage dip, the operation of the PC can be compromised. Several malfunction criteria are reported in literature [29], [30], [35]. Typically, sensitivity of personal computers to voltage dips is expressed by a single voltage-tolerance curve, corresponding to the restarting/rebooting malfunction criterion (Figure 3-22). This curve indicates that voltage dips longer than the specified duration and deeper than the specified voltage magnitude will lead to a restarting/rebooting of the computer. In assessment of computer sensitivity, restarting/rebooting of computer is denoted as the “hardware”

malfunction criterion. However, tests showed that a voltage dip or short interruption might cause interruption of some of the operations performed by the computer without the restarting/rebooting of the computer [29]. Two additional malfunction criteria used in the tests were: a) lockup of a read/write operation, and b) blockage of the operating system. They are denoted as “software” malfunction criteria. For some of the tested computers, these two additional malfunction criteria resulted in different voltage-tolerance curves, indicating higher dip sensitivity than in case of hardware malfunction criterion. As the computer does not reboot in case of software malfunction criteria (but it has stopped functioning because its operating system is blocked), the use of only restarting/rebooting voltage-tolerance curve can be especially misleading when continuous control of the process by the computer is of a particular importance and interest.

Figure 3-22 shows voltage-tolerance curves for a PC with switched-mode power supply for a 230V/50Hz and 110V/60Hz supply system.

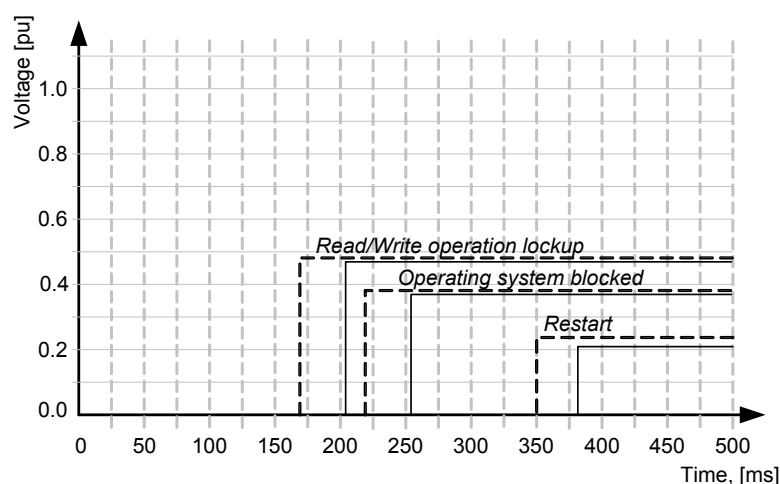

Figure 3-22 Voltage-tolerance curves for PC with switched-mode power supply: three different malfunction criteria and two different supply voltages (230V/50 Hz, solid line, and 110V/60Hz, dashed line) [29].

As shown in the figure, lower supply voltage results in higher sensitivity. Additionally, the PC is more sensitive if lockup of read/write operation is used as a malfunction criterion. The read/write operation corresponds to a specific loading condition. The power/current consumption of the PC is higher during the read/write operation than when the computer is idling with the operating system running and not performing any other particular task. Accordingly, for other loading conditions other voltage-tolerance curves will be obtained, most likely between those shown.

At voltage recovery, the capacitor in the power supply module is quickly recharged through the diode rectifier. The resulting high inrush current stresses the diodes in the rectifier and all other components/circuits present at the front end, which can result in a hardware failure, or operation of some input protective devices. If many PCs are connected to the same electrical circuit, the cumulative current can activate dedicated fuse or circuit breaker. This is illustrated in Figure 3-23, which shows the inrush current for a PC/device with a single-phase diode rectifier. For 90° point-on-wave of voltage ending (i.e. when voltage recovers at the maximum value), the highest post-dip inrush current will be obtained. It should be noted that maximum inrush current is also influenced by the source impedance, where generally a higher source impedance results in lower inrush currents.

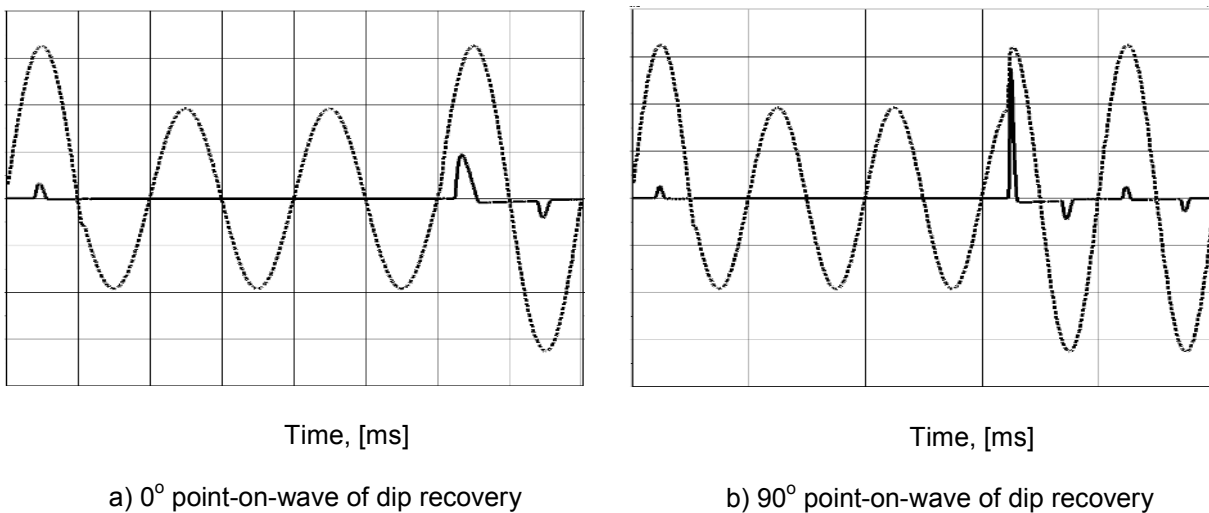

Figure 3-23 Illustration of the influence of the point-on-wave of dip ending on the inrush current of a single-phase diode rectifier (dotted line - input voltage, solid line - input current; vertical scale: 100 V/division and 10 A/division; horizontal scale: 10 ms/division).

3.2.7 Power distribution system and equipment

Interruption of the process can also be caused by malfunctioning of an industrial power distribution system. It is well known that transformers have high inrush currents ([1], [27]), which, apart from inducing shallow voltage dips, can result in transformer saturation. This may be misinterpreted by a protective device connected to this current transformer. At the conclusion of a voltage dip, many devices (as previously discussed) draw increased current from the system, and coordinated parameter-setting of protective devices is crucial

to avoid process trips due to these short-time over-current situations. A typical example is the over-current setting of a motor starter device.

Finally, if a process generates electricity by means of a combined heat and power, or using some other, e.g. renewable-based generation, the interaction of the generation unit(s) and the grid during dips must be studied. The generation unit may be switched off during a dip, or may transfer to islanded operation. If good coordination is achieved, it may also be possible to stay synchronised to the grid. In doing so, the generator can help to reduce the initial or overall impact of a dip by feeding the process with alternative supply.

3.3 Processes immunity

3.3.1 Introduction

This section presents a method for quantifying the immunity of industrial processes against voltage dips. The ultimate goal is to keep the industrial processes up and running during a voltage dip event, or at least know which voltage dips will cause a process to trip, in order to take the optimal measures for process recovery. An industrial process contains a group of devices working together and interacting with each other. Depending on the process, the number of devices can be rather high and their dip immunity characteristics may be rather diverse. This usually results in large differences between distinctive characteristics of different processes, making each process a unique case study.

As a common practice, engineers try to identify the most critical device(s) in a process. Typically, because voltage dips are electrical phenomena, electrical engineers are appointed to identify critical equipment and to increase their dip immunity. This effort is not trivial. The interaction between different devices and their impact on the overall process performance is often beyond the knowledge and experience of electrical engineers, and is not always well or fully understood. The number of involved or relevant devices can be very high in large and complex processes. Electrical engineers, therefore, may be tempted to take into account only the power processing equipment, or equipment known to be vulnerable to voltage dips (such as adjustable speed drives or contactors). Too often, however, it has been found that processes trip due to monitoring and measuring equipment, controllers or protective equipment – equipment that was not initially considered.

For this section, the Working Group began by gathering information about the dip susceptibility of a wide variety of processes. It became clear, however, that it is difficult to use information from one process to evaluate another, even within the same industry. During working group discussions, it also became clear that the formulation of a general framework for evaluating existing or new production facilities could be the most valuable contribution, assuming that this framework is able to identify the most critical devices, equipment, or groups of equipment within a given process.

This section starts with description of some typical processes (discussion includes only a limited number of processes), indicating typical equipment used there. These processes can roughly be split up in two groups. The first group of processes is characterised by a slow change of process parameters after dip-caused tripping or malfunction of process equipment, such as pressure, temperature, tank levels, etc. In the second group, process parameters change quickly when equipment is tripped during the dip. Examples of those include tight torque, speed or position control and synchronisation between movements in machinery.

After this classification, the chapter introduces a general framework for the assessment of process dip performance. The Process Immunity Time (PIT) concept is defined, linking each process parameter with one or more devices. By means of a simplified process model, the usefulness of the proposed framework to analyse process sensitivity to voltage dips is illustrated in a step by step procedure. The chapter concludes with two examples, for which the PIT concept was used and validated.

3.3.2 Process behaviour

Understanding the behaviour of a process during and immediately after a voltage dip or short interruption is essential for taking the correct measures to increase the process dip immunity to a desired level. This understanding requires a lot of effort and in most cases is only valid for one specific process. Some case studies describing the impact of voltage dips on specific processes can be found in literature. They are, however, very specific and hard to translate to the other, often quite similar processes [34]-[37]. Some engineering companies now specialise in offering services for identifying sensitive equipment and suggesting corrective measures.

When designing a new process, the impact of voltage dips is rarely the first concern, and in many cases it is not considered at all. As a result, the awareness (or appreciation) of the involved organisations, companies or factories to voltage dips increases as the cost associated with dips grows. The cost is actually the main driving factor to examine the process and to take corrective retrofit measures. Typically, electrical engineers are appointed to address (improvement of) process dip performance. It will be shown later in this chapter that appointing only electrical plant specialists may not be the best option.

After studying the responses of several different processes to voltage dips, two categories were identified: a) processes requiring tight control of relevant process parameters, and b) processes where large variations of relevant process parameter can be allowed without disturbing the entire process or the desired process outcomes. As mentioned, examples of the first category are processes with synchronised movements, tight speed or position control, or accurate temperature control. Examples of the second category are processes with fluid level and flow rate control, air fans, etc.

In most cases, a mix of both types of processes is present in one industrial or production facility. To illustrate such an example, a paper production facility is examined firstly. After the wood preparation phase, the pulp is produced and transformed into paper in the paper production part of the process.

Wood preparation: Barking drum, Wood chipper

In this part of the process, normally direct on-line (DOL) induction motors are used, and the impact of voltage dips is related to their effects on motor contactors. The overall impact of voltage dips on the production is low, because of the large volume of stored wood chips, which gives enough time to restart any motor tripped during the dip. The important part of process dip performance assessment is restarting of wood chipping motor with logs inside the machine, which can create another voltage dip.

Pulp preparation: Refiner, Blower, Pumps

The refiners are normally large synchronous motors, with rated powers from 1,000 HP to 25,000 HP (750 kW – 19 MW). The blowers and pumps are typically equipped with adjustable speed drives (ASDs) and directly connected induction motors. The dip immunity of this part of the process depends on the sensitivity of ASDs used for the pumps and

blowers, because the process control will not allow material jams and must also maintain the fluidity of the material through the process.

Paper Production: Press, Pumps, Calenders, Dryers, Reels, Winders

This part of the process is the most vulnerable to voltage dips, because of the required synchronisation between the different production stages. To control the speed difference between the different production stages, ASDs are used. Voltage dips can disturb this synchronisation, resulting in tearing apart the paper sheets. In this case, subsequent restarting of interrupted process is time consuming and very expensive.

It can be generally concluded that paper production stage is the most sensitive part of the process, while pulp production and wood preparation stages are less sensitive. The two latter stages are characterised by a “buffer capacity”, enabling them to overcome short interruptions. Figure 3-24 shows the impact of voltage dips on the operation of the whole process. The red dots indicate voltage dips that resulted in the interruption of the process, typically related to deeper dips, or dips with longer duration. The black dots refer to dips that did not disturb the process.

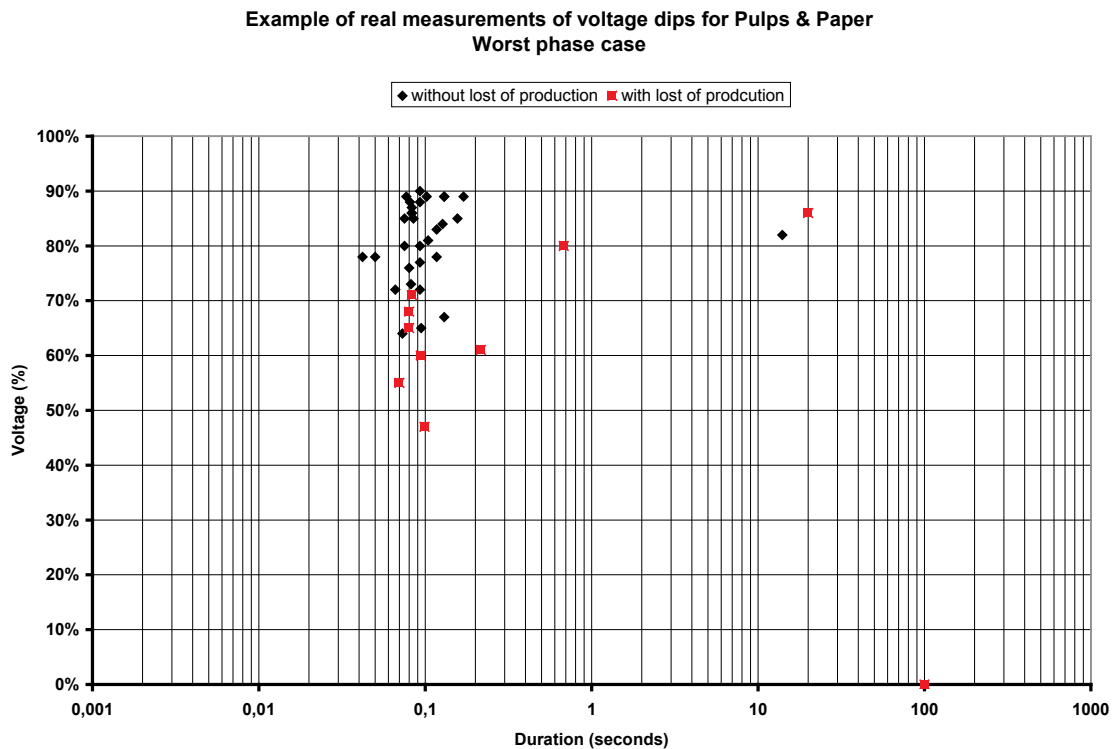

Figure 3-24 Impact of voltage dips on the normal operation of a pulp and paper process.

3.3.3 Process Immunity Time concept

The purpose of methodology for the assessment of process dip immunity proposed in this section is to identify the critical equipment within a process. This identification is the basis for a general Process Immunity Time (PIT) concept, in which each individual device in the process is linked with the process parameter(s) on which the device has an impact. In this analysis, “device” also includes the switchgear which connects it to the supply. For example, a DOL induction motor together with its motor starter and dedicated protection circuits/components is considered as one “device”. For each device, the impact of a short interruption on that device is analysed, as interruption of a supply voltage is a worst case scenario during the determination of PIT. The behaviour of the equipment under such conditions is easy to understand. Furthermore, testing for PIT is relatively simple, because generating a short interruption is straightforward compared to voltage dip testing⁶. Figure 3-25 shows how the PIT can be determined. Starting with the nominal process parameter value p_{nom} (controlled by the device), a supply voltage interruption is assumed to occur at t_1 . As a result, the process parameter starts to deviate from its nominal value. This may happen instantaneously or, as depicted in Figure 3-25, after a time interval Δt . This delay might be associated with the tripping of the equipment Δt seconds after the actual supply voltage interruption, or with a “dead time” in the process response. At time t_2 , the process parameter value crosses the lower boundary p_{limit} , below which normal operation of the process cannot be maintained⁷. Starting from t_2 onwards, the process no longer operates as intended and must be either shut down, or re-started, or otherwise corrected. The PIT is defined as the time interval between the start of the voltage interruption and the moment the process parameter goes out of the allowed tolerance limit (i.e., below the threshold).

$$PIT = t_2 - t_1$$

⁶ Voltage dip testing requires specific equipment (see Chapter 4), which can be expensive and usually has a limited power range.

⁷ The boundary p_{limit} might be determined by safety requirements, or as a limit preventing damage to process equipment, or it simply marks such a variation of process parameter that result in defective products.

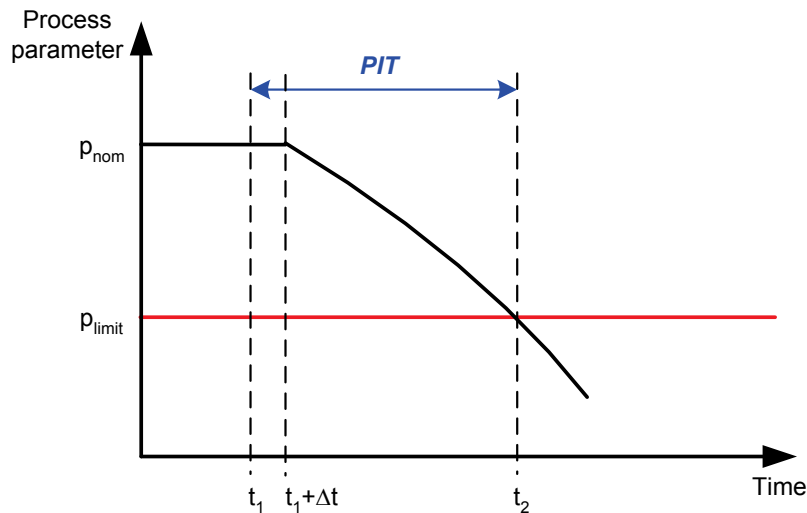

Figure 3-25 Definition of the Process Immunity Time (PIT) for an equipment within the process.

The first step in the proposed PIT assessment is to generate a list of all devices within the process. The list must be as complete as possible, as process interruptions are often caused by equipment whose impact on the process is not always fully understood (such as sensors, ice-cube relays, or control equipment).

The process is then split up in functional units (functions) or levels. The number of levels required depends on the complexity of the process. The lowest level contains individual equipment, for which involved process parameters should be identified. Table 1 illustrate this methodology on an example of a simplified chemical reactor process (Level 1), which is part of a chemical plant. In Level 2, three subsystems are identified: the cooling system of the reactor vessel, the reaction process and the controls.

The cooling of the reactor is accomplished by means of a DOL induction motor (DOL IM 1), which drives the water pump. This device directly affects the reactor's cooling water temperature, which is a critical parameter for the overall process. The pumping system also contains a small oil pump, operating at high oil pressure to lubricate the main water pump. The cooling of the water circuit is realised by means of a DOL induction motor driving an air fan (DOL IM 2).

The reactor vessel is equipped with a feed pump (DOL IM 3), which controls the flow rate of the chemicals. For a good and homogenous reaction, a speed regulated mixer is required. This is accomplished using an adjustable speed drive (ASD 1). As the reaction

also requires control of oxygen level, another ASD is used to control the air inlet (ASD 2). As both temperature and oxygen controls are required for a good reaction process, temperature and oxygen sensors are connected to a programmable logic controller (PLC) that is taking care of the control actions. The temperature sensor is connected directly to the PLC, while the oxygen sensor is supplied separately and communicates with the PLC over a fieldbus. The PLC is equipped with an Uninterruptable Power Supply (UPS), to keep both the PLC and the fieldbus up and running during voltage dips and short interruptions.

In this example process, every device is related to only one process parameter. In some systems, however, it is possible that one device influences or controls more than one process parameter. In that case, all the process parameters involved should be listed. Some process parameters may also be controlled by multiple devices. To correctly interpret these interconnections and finally to determine the PIT for each equipment–parameter combination, electrical engineers, process engineers and instrumentation engineers need to share relevant information and to understand the limitations of the power supply system and the process itself. In order to determine the PIT, it is essential to establish the nominal value and upper and lower limits for each process parameter. This is typically the responsibility of process engineers.

For each “equipment–parameter” combination, the PIT is determined by considering a supply interruption to only that device. For an existing process, recordings of past voltage disturbances, and their effects on the process, can be very helpful. For new processes to be built, simulations, calculations or experience from similar processes can be used. If possible, field tests should be applied, as they are the most reliable way to determine the exact PIT values. However, field tests are not always possible, due to e.g. safety reasons or, in case of a continuous process, production interruptions may be forbidden.

Once all PIT values are determined, a ranking of the most critical equipment can be made. This ranking can be done for each defined level within the process. At Level 3 of the example process in Table 1, the oxygen measurement sensor is the most critical device, followed by the oil pump and the ASD2 controlling the oxygen inlet. The overall PIT of the reactor vessel (including its control) is dictated by the dip sensitivity of the oxygen sensor, and is as low as 1 second. The DOL IM 2 driving the fans for cooling the water circuit and

the PLC with UPS are the least critical devices. At Level 2, the control system is the most critical part of the process, followed by the cooling system and the reaction process itself.

Table 1. Equipment list and PIT values for a simplified chemical reactor process.

LEVEL 1	LEVEL 2	LEVEL 3	Process parameter	PIT	Priority	Action
Reactor						
	Cooling					
		DOL IM 1 (water)	Reactor cooling water temp	5s	4	Restart 1
		Oil pump	Oil pressure	1,5s	2	Crucial
		DOL IM 2 – fan	Cooling of the water circuit	3min	7	Restart 3
	Reaction					
		DOL IM 3 (feed)	Flow rate	30s	6	Restart 2
		ASD 1 (mixer)	Reaction time	6s	5	Restart
		ASD 2 (air)	% O ₂	2s	3	Mitigate
	Control					
		Temperature sensor	Reactor temperature	1 h	8	
		Oxygen measurement	% O ₂	1s	1	Mitigate
		PLC with UPS		1 h	8	

3.3.4 Using Process Interruption Time for selecting the appropriate mitigation strategy

Based on the PIT analysis, processes, functions and equipment can be divided into two groups: those with high PIT values and those with low PIT values. The terms “high” and “low” are related to the typical duration of a voltage dip. Processes with high PIT values are perfectly capable of operating without supply voltage for a period of time longer than the typical duration of a voltage dip (as in case of, e.g., ventilation systems, or systems for fluid level control). Usually, this type of process contains some inherent buffering capabilities against short interruptions. The DOL IM 3, which controls the flow rate of the chemicals in the previously considered simplified chemical reactor example, has a PIT of

30s. At the occurrence of a voltage dip or a short interruption, this device can be shut down or disconnected from the supply. After disconnection, the motor speed will start to decrease. Once the voltage has recovered, the equipment can be reconnected to the supply. In the case of the DOL IM 3, the motor will reaccelerate and restore the process parameter value. This procedure of disconnecting and restarting the equipment can only be successful if the duration of the voltage dip or interruption, t_{dip} , augmented with the required restarting (or recovery) time of the equipment, $t_{restart}$, is lower than its PIT value:

$$t_{dip} + t_{restart} < PIT$$

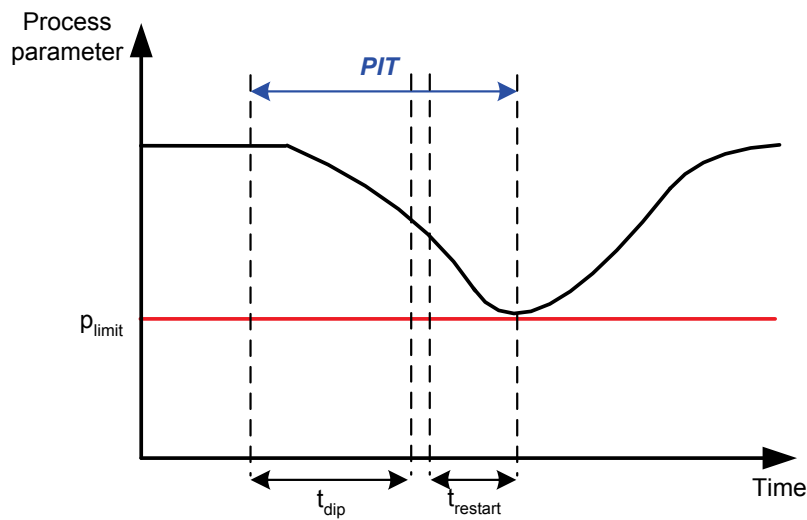

Figure 3-26 Successful restart of the equipment after a voltage dip with duration t_{dip} .

Figure 3-26 shows the process parameter behaviour for a controlled stop and restart action. The process parameter value remains within the allowed range. It should be noted, though, that the time interval between t_{dip} and $t_{restart}$ may be dictated by the scanning time or response time of the control system governing the restart procedure.

If the process contains several DOL motors with high PIT values, each of which controls the corresponding process parameter, shutdown and a coordinated restart procedure is a particularly cost-effective dip mitigation method. In the case of big motors, restarting all motors simultaneously after the end of the dip (i.e. during the voltage recovery stage), may cause very high restarting currents and an extended voltage recovery, or even a voltage collapse. The PIT values can be used in this case to determine the optimal restarting sequence of the motors.

The second group of processes contains equipment with PIT shorter than the typical duration of a voltage dip. They trip quickly after the occurrence of a voltage interruption or a voltage dip (as in case of, e.g., systems for speed control, or synchronised motion control). Controlled shut down and restart is not an option here. For these processes, knowledge of the individual equipment behaviour under dip conditions is required to take the correct measures to improve overall process dip performance. The oxygen measurement in Table 1 has a very low PIT value. The oxygen measurement is fed directly from the supply, and at the occurrence of a voltage dip, this sensor trips within 1 second. Consequently, the value for the oxygen concentration in the reactor vessel is no longer sent to the controlling PLC, which interprets the lack of information from the oxygen measurement system as an unacceptable state and decides to shut down the entire reactor process. Power requirements of the oxygen measurement sensor are small, so a simple solution would be to supply this sensor from the UPS, already available for the PLC system.

The resulting PIT value for the oxygen sensor after this modification in supply will then increase from 1 second to approximately 1 hour (depending on the amount of energy stored in the UPS). The overall PIT for the reactor vessel is now dictated by the PIT of the oil pump in the cooling water subsystem.

The PIT procedure, as described above, identifies critical equipment that requires mitigation techniques, and non-critical equipment that can be shut down and restarted without causing interruption of the whole process. The sensitivity of the second category of equipment to voltage dips is much lower, as it uses inherent buffering capabilities available within the process. This suggests that when designing new processes, one strategy to improve its dip performance is to add extra buffers. In most cases, this will be less expensive compared to other dip mitigation techniques. In the considered example, the reaction process is very sensitive to interruptions in the air (oxygen) supply. Instead of directly driving the air inlet, an intermediate air buffer (accumulator) may be installed between the ASD 2 driving the fan and the reactor vessel. Starting from the required PIT for this device, the required sizing of the accumulator can be realised. The same strategy can be used to increase the PIT value of the oil pump in the cooling water subsystem.

3.3.5 *Integrating voltage dip levels in the PIT procedure*

So far, the procedure assumed a supply interruption as a starting condition to determine the PIT. As a result, the most critical equipment and equipment that can be stopped and restarted in a controlled manner are identified. If typical voltage dip levels are known, or a voltage-tolerance level for the process is specified, the procedure can be refined for those devices that are critical for process dip performance. Adjustable speed drives, for example, cannot ride through short interruptions, but in most cases are capable of withstanding symmetrical three-phase voltage dips with remaining voltage up to 70%, and unbalanced dips with even lower remaining voltage. For such types of equipment, different PITs for different voltage dip levels can be useful. In most cases, information from manufacturers (e.g. voltage-tolerance curves) is required to accomplish this refinement.

3.3.6 *Flowchart for evaluating equipment behavior*

The PIT procedure assumes that a device always contains contactor, breaker or manual switch, indicating how the device is connected to the supply. A breaker is immune to dips, as it is a mechanically latched device, which is manually operated or positively driven to operate by an electromechanical trip system. Contactors, however, may trip due to a voltage dip or interruption. When examining the equipment behaviour, the types and characteristics of associated switchgear must be taken into account. Figure 3-27 shows a general flowchart for the analysis of this problem, in which only sensitive electrical equipment is considered. Protective devices in the process power distribution system are not considered. A distinction is made between manual switches, breakers and contactors. Manual switches are typically used with sensors and control systems. If the PIT for this equipment is low⁸ and if no back-up supply is available, the process may not ride-through.

Contactors are available with and without dip protection. Contactor without dip protection may disconnect the equipment from the supply during a voltage dip. The equipment is then no longer active. If there is no auto-reset (reclosing) for the contactor when voltage recovers and no restarting mechanism for the equipment, the process will not ride-through. If restart is possible, and the PIT is not too small, the process can continue its normal operation.

⁸ In the flowchart (Figure 3-11), a 4 second limit is suggested. This value, however, depends on the actual type of process and specific requirements for its operation.

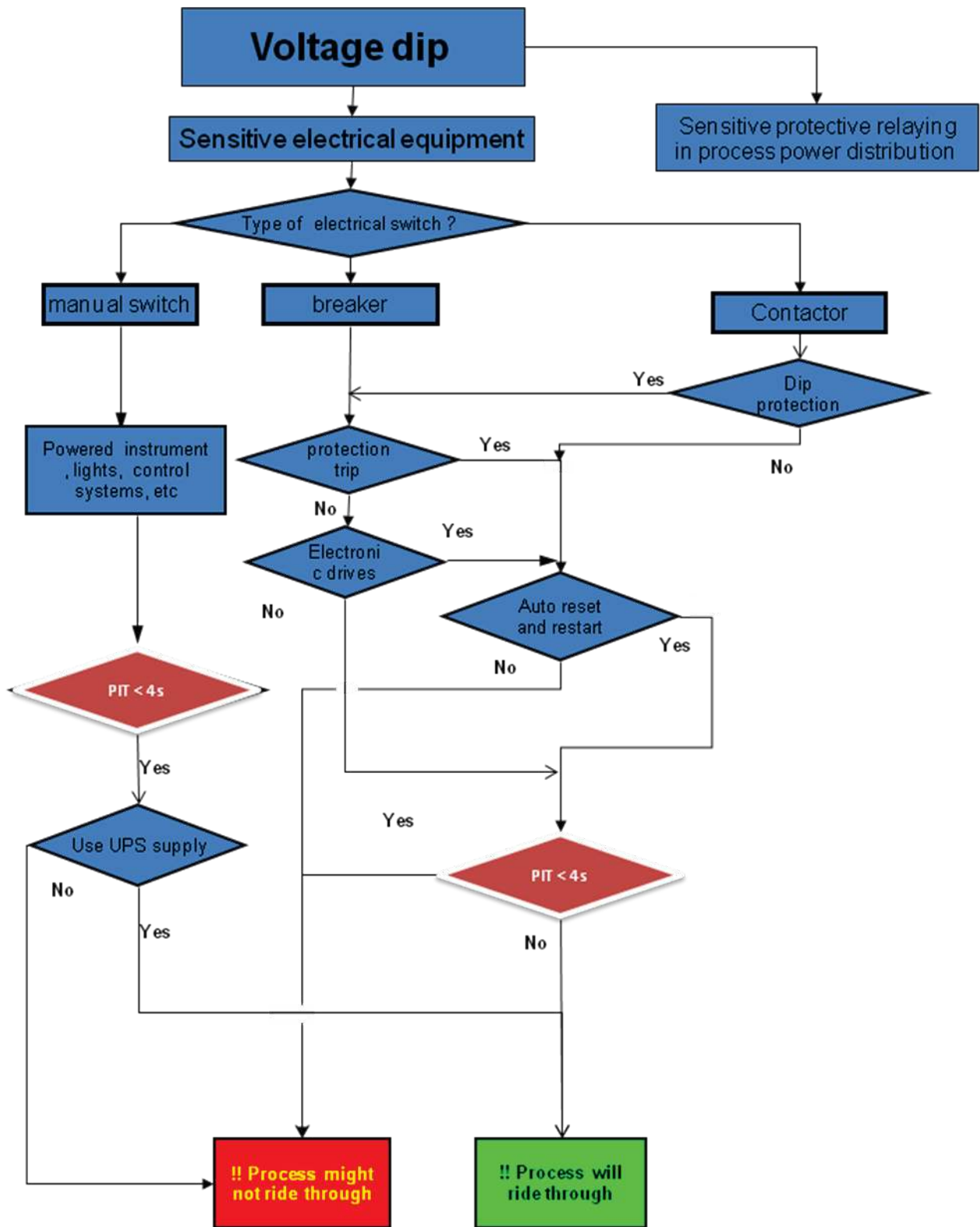

Figure 3-27 Flowchart for the analysis of the behaviour of an equipment based on the type of connecting device (breaker, contactor or manual switch) between the grid and the equipment.

For contactors with dip protection, the equipment will stay connected to the supply system during the dip. Whether this equipment will continue to operate, depends on its protection settings. If the equipment trips and an auto reset or manual restart can be realised within the PIT time, the process would ride through.

3.3.7 Example 1: HVAC system in a pharmaceutical manufacturing site

To help the reader understand the PIT framework, we present a first example that describes the use of PIT in a Heating, Ventilation and Air Conditioning (HVAC) system in a pharmaceutical manufacturing site [37], [38].

A detailed description for this dip immunity assessment study, including mitigation, can be found in Chapter 7, Appendix 7.C. Figure 3-28 shows the schematics of the test plant. Like most similar processes, it must comply with stringent sterility standards set by various drug-production regulatory bodies. A complex HVAC system maintains the sterile environment in the production area by enforcing a positive pressure difference between the production area and external surrounding areas. The HVAC system, consisting of ducts, fans, motors and other equipment, provides a constant flow of clean air in forced circulation, maintaining a positive difference in pressure. Induction motors, typically used as a constituent part of an HVAC system, are generally driven and controlled by ASDs.

There has been an increased number of reports of HVAC failures as a consequence of ASD malfunctions due to voltage dips (considered ASDs are based on a passive front-end technology). The HVAC failures caused total plant shutdown, leading to appreciable loss in revenue, long plant downtimes for cleaning and restarting, and frustration among the staff. Preliminary investigation has found that these failures are direct consequence of ASD malfunction, and coincided with voltage dip events recorded at the 11kV main switchboard at the site entrance. The PIT procedure is used to get better understanding and to provide quantitative information about the process behaviour during a dip or interruption.

Table 2 lists the functions and devices in the process shown in Figure 3-28. The positive static air pressure for the plant's core sterile area is maintained by two sets of fan pairs: one pair for clean air supply, and one pair for exhaust. Each fan from a pair operates at 50% of nominal speed to meet an N-1 security criterion. If one drive-controlled fan fails, the Plant Control System (PCS) commands the other drive to compensate for the incurred

loss of air volume. The low-power equipment controlling the process and logging data have a UPS back-up.

Data collected during both independent tests and dip-caused plant shutdown scenarios were used to evaluate the PIT. When both of the supply fans fail, the differential pressures collapse within 34 seconds (column PIT (1) in Table 2). Similar analysis in case when only one fan malfunctions resulted in a lower PIT value of 30 seconds. As one fan continues to circulate air under these conditions, the pressure will drop faster, resulting in a more sensitive process, compared to the situation when both fans malfunction/trip. So far, the minimum PIT in the HVAC system is 30 seconds. With one fan failing, the speed of the other one could be increased to compensate for the reduced air flow. However, the PCS, which monitors the plant's operating condition and dictates the speed set point for the fans, uses a sampling time of 20 seconds. As a result, this sampling time dictates the PIT of the whole HVAC system, indicating the major impact of the control system on the overall process operation.

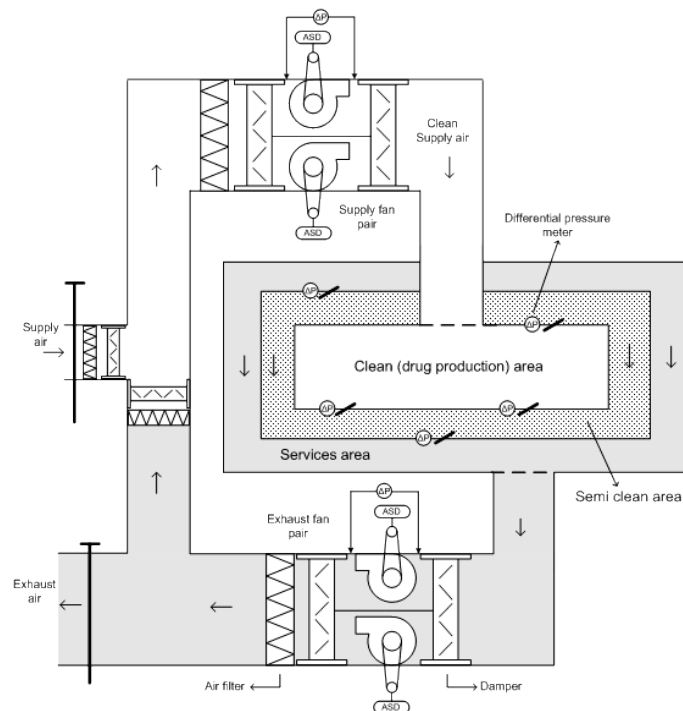

Figure 3-28 HVAC schematic of the example pharmaceutical plant, [37].

Table 2. Equipment list and PIT values for an HVAC system in a pharmaceutical plant/process.

LEVEL 1	LEVEL 2	LEVEL 3	Process parameter	PIT (1)	PIT (2)	PIT (3)
HVAC						
	Supply air					
		ASD – fan 1	Δp	34 s	30 s	
		ASD – fan 2	Δp	34 s		
	Exhaust air					
		ASD – fan 3	Δp	34 s	30 s	
		ASD – fan 4	Δp	34 s		
	PCS					
		PLC		2 h		20 s
		Δp sensors		2 h		

3.3.8 Example 2: Cooling tower system feeding an air compressor

A second example describes a cooling tower system as used in many industries (Figure 3-29). The system consists of a motor and pump for circulating the cooling water, motors to drive air fans on the cooling tower and small motors driving chemical dosing pumps to control the water quality. When the circulation pump is lost, the cooling water temperature $T_{\text{cooling water}}$ goes outside the allowed margin in 10 seconds. When the set of paralleled air fans drops out, the PIT related to $T_{\text{cooling water}}$ is 15 minutes. The chemical dosing pumps can be out of service for 1 hour before the water becomes contaminated.

A large air compressor uses the cooling water and is connected in series with the cooling water circuit. The compressor was purchased as a whole and is treated as a packaged unit. This unit contains the compressor, a compressed air buffer to guarantee autonomy time of 30 seconds for delivering the required air flow Q_{air} when electrical supply to the compressor is lost, sensors, controls and protection. The air compressor uses an internal cooling water flow measurement $Q_{\text{cooling water}}$ to decide on its cooling conditions instead of the temperature measurement used in the control of the cooling tower. When the motor–pump combination in the cooling water system is lost, the air compressor control system

senses a reduction in $Q_{\text{cooling water}}$ within 3 seconds and shuts down the compressor system⁹. Table 3 lists all the equipment and their corresponding PIT values.

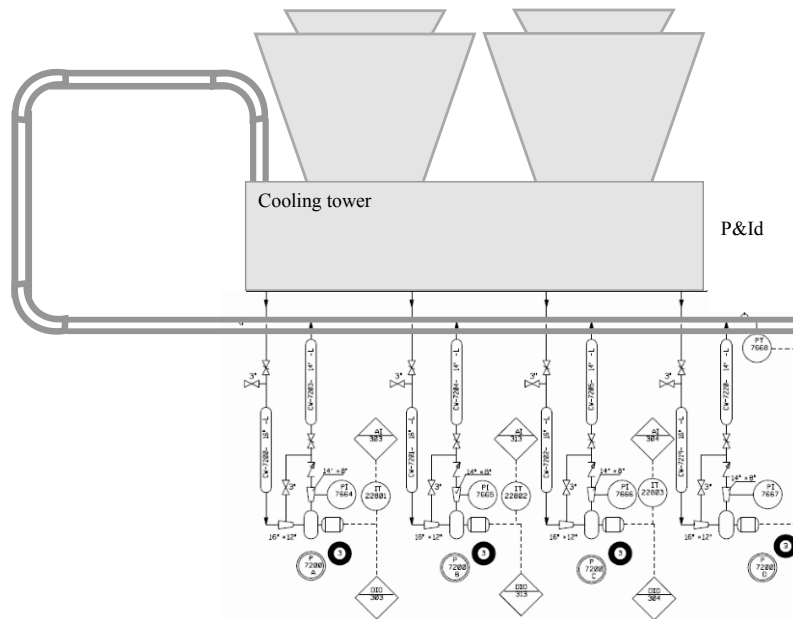

Figure 3-29 Cooling tower schematic.

If the cooling tower system and the air compressor are analysed separately, neglecting the coupling between them in the exchange of cooling water, the overall PIT of the process is estimated as 10 seconds. A restart procedure for the cooling water pump requiring 5 seconds would then be appropriate to restore the function of the cooling system. Due to the interaction between the cooling tower and the compressor, the actual PIT is 3 seconds. Within this short time interval, the cooling water pump cannot be restarted after a voltage dip. Another and most likely more expensive mitigation technique will be required. Detecting the interaction between different process functions is not always easy to achieve. Again, bringing together engineers from different disciplines can be most helpful here.

As can be seen from Table 3, the air fans on the cooling tower are not critical equipment (PIT=15 min). This PIT was determined considering tripping of all air fans at the same moment, which is the worst case scenario. For restarting the air fans, a conservative

⁹ Large compressors are typically equipped with oil circulating systems fed by an independent oil pumping system. Although loss of cooling water pumps can be the cause of failure, the loss of the lubricating pumps may also disrupt operation, resulting in an even lower PIT.

approach is to determine the minimum number of air fans and how fast they must be restarted to allow recovery of the whole system.

Table 3. Equipment list and their PIT values for a cooling tower interacting with an air compressor.

LEVEL 1	LEVEL 2	LEVEL 3	Process parameter	PIT	Priority	Action
Cooling system						
	Cooling Tower					
		Cooling water pump	$T_{\text{cooling water}}$	10 s	1	Mitigate
		Air fans	$T_{\text{cooling water}}$	15 min	3	Restart
		Chemical dosing pumps		1 h	> 1h	Restart
	Air compressor	Air buffer	Q_{air}	30s	2	
		Internal compressor cooling control	$Q_{\text{cooling water}}$	3 s	1	

3.4 Conclusions

The main contribution of this chapter is the introduction of the Process Immunity Time concept to identify the most critical equipment in the process. The lower the PIT, the more critical is the equipment for the process. The advantage of the proposed framework, although it may look time consuming, is a guarantee that all relevant equipment is incorporated in the analysis. The first challenge for the successful application of the proposed framework is gathering the required information. Too often, only electrical engineers are involved in the voltage dip susceptibility study of a process. They are not always aware of the complex interactions between the different parts of the process, different process parameters and different devices. Furthermore, they often focus exclusively on those devices that are processing the power, neglecting the impact of sensors, protection and control equipment.

Bringing together electrical engineers, instrumentation engineers, process engineers and control engineers is therefore essential for a reliable analysis.

The awareness among the engineers on the importance of sharing relevant information is crucial for a good understanding of the overall process dip performance. For equipment with low PIT values, the information on their behaviour during dips is required for the correct analysis of the process dip immunity. Therefore, the chapter gives an overview of dip sensitivity of general equipment types, indicating which parameters may have an impact on equipment (and process) responses. These parameters are classified in voltage-related, equipment specific and non-electrical parameters. It is generally concluded that the relevant/influential parameters will most likely be different for different application. As a result, predicting the exact equipment behaviour in a specific process is not a straightforward procedure. This chapter, therefore, has focussed on the reported dip sensitivity of the equipment in literature (based on extensive lab testing and on simulation results), which was then combined with the expertise from the Working Group members. The parameters having the highest impact on the dip sensitivity of a particular type of equipment are highlighted, together with the different malfunctioning/tripping mechanism of the equipment.

3.5 References

- [1] M.H.J. Bollen, Understanding power quality problems, Voltage sags and interruptions, IEEE press series on power engineering, Piscataway, 1999.
- [2] Electromagnetic compatibility (EMC), Group of IEC Standards 61000, International Electrotechnical Commission, 1990-2003.
- [3] A. E. Turner and E. R. Collins, The Performance of AC Contactors During Voltage Sags, in Proc. 7th International Conference on Harmonics and Quality of Power ICHQP '96, pp. 589-595, Oct 1996.
- [4] F. D'hulster, K. Stockman, J. Desmet, R. Belmans, Modeling of the behavior of AC undervoltage relays during voltage dips, International conference on modelling and simulation MS2002-IASTED, Marina Del Rey, CA, USA, May 13-15, 2002; pp. 142-146.
- [5] S. Z. Djokic, J. V. Milanovic and D. S. Kirschen, Sensitivity of ac coil contactors to voltage sags, short interruptions and undervoltage transients, IEEE Transactions on Power Delivery, Vol. 19, No. 3, pp. 1299-1307, July 2004.

- [6] J.C. Gomez, M.M. Morcos, Contactor immunity related to voltage sags, 19th International Conference on Electricity Distribution, CIRED, Vienna, 21-24 May, 2007.
- [7] J. Pedra, F. Corcoles and L. Sainz, Study of AC Contactors During Voltage Sags, 10th International Conference on Harmonics and Quality of Power, Vol. 2, pp. 565-570, 2002.
- [8] A. Leiria, P. Nunes, A. Morched and M. Correia de Barros, Induction Motor Response to Voltage Dips, International Conference on Power Systems Transients – IPST, New Orleans, USA, 2003.
- [9] Das J.C., The effects of momentary voltage dips on the operation of induction and synchronous motors, *IEEE Transactions on Industry Applications*, Vol. 26, pp. 711-718, 1990.
- [10] J.V. Milanovic, M.T. Aung and S.C. Vegunta, The Influence of Induction Motors on Voltage Sag Propagation – Part I: Accounting for the Change in Sag Characteristics, *IEEE Transactions on Power Delivery*, Vol. 23, No. 2, pp. 1063-11071, April 2008.
- [11] J. Pedra, F. Corcoles and L. Sainz, Effects of unsymmetrical voltage sags on squirrel-cage induction motors, *IET Gener. Transm. Distrib.*, Vol. 1, No. 5, September 2007.
- [12] L. Guasch, F. Corcoles and J. Pedra, Effects of unsymmetrical voltage sags on induction motors, *IEEE Transactions on Power Delivery*, Vol. 19, No. 2, pp. 774-782, April 2004.
- [13] C. Brozio, The effects of a brief voltage dip on the performance of a power system with motor loads. (available at www.measurlogic.com)
- [14] M.D. McCulloch, The effect of voltage dips on induction motors. (available at www.measurlogic.com)
- [15] G.G. Richards, M.A. Loughton, Limiting Induction Motor Transient Shaft Torques Following Source Discontinuities, *IEEE Transactions on Energy Conversion*, Vol. 13, No. 3, September 1998.
- [16] F. Carlsson and C. Sadarangani, Behavior of Synchronous Machines Subjected to Voltage Sags of type A, B and E, *EPE Journal* Vol 15, No 4, December 2005.

- [17] J. Pedra, L. Sainz, F. Corcoles, J. Bergas, A. de Blas, Effects of balanced and unbalanced voltage sags on DC adjustable-speed drives, *Electr. Power Syst. Res.*, 2007.
- [18] Cao R. and Collins E.R., The Effect of Load Types on The Behavior of AC Motor Drives During Voltage Sags, *Conference Proceedings of 10th ICHQP'02*, Vol. 1, pp. 353-358, 2002.
- [19] Duran-Gomez J.L., Enjeti P.N. and Ok Woo B., Effects of Voltage Sags on Adjustable-Speed Drives: A Critical Evaluation and an Approach to Improve Performance, *IEEE Transactions on Industry Applications*, Vol. 35, pp. 1440-1448, 1999.
- [20] K. Stockman, J. Desmet, R. Belmans, Impact of harmonic voltage distortion on the voltage sag behaviour of adjustable speed drives, *XVII International Conference on Electrical Machines (ICEM 2006)*, Chania, Crete Island, Greece, September 2-5, 2006.
- [21] S. Z. Djokic, K. Stockman, J. V. Milanovic, J. J. M. Desmet and R. Belmans, Sensitivity of AC Adjustable Speed Drives to Voltage Sags and Short Interruptions, *IEEE Transactions on Power Delivery*, Vol 20, No. 1, 2005, pp. 494-505.
- [22] R.A. Lukaszewski, R.W. Reese, R.M. Tallam, D.W. Kirschnik, M. Stephens, Response of adjustable speed drives with active and passive rectifiers to various voltage sag test methodologies, *PQA 2006*, Atlanta, GA, July 24-26, 2006.
- [23] K. Stockman, F. D'hulster, K. Verhaege, M. Didden, R. Belmans, Ride-through of adjustable speed drives during voltage dips, *Electric Power Systems Research* , Vol. 66, Elsevier, 2003; pp. 49-58.
- [24] A. von Jouanne, P. N. Enjeti and B. Banarjee, Assessment of Ride-Through Alternatives for Adjustable-Speed Drives, *IEEE Transactions on Industry Applications*, Vol. 35, pp. 908-915, 1999.
- [25] K. Stockman, F. D'hulster, R. Belmans, Cost effective solutions to increase the immunity of AC drives against voltage dips, *11th European Conference on Power Electronics and Applications 2005*.
- [26] J. Pedra, F. Corcoles, F.J. Suelves, Effects of balanced and unbalanced voltage sags on VSI-fed adjustable-speed drives, *IEEE Transactions on Power Delivery*, Vol.20, No. 1, pp. 224-233, January 2005.

- [27] J. Pedra, L. Sainz, F. Corcoles, L. Guasch, Symmetrical and Unsymmetrical Voltage Sag Effects on Three-Phase Transformers, *IEEE Transactions on Power Delivery*, Vol. 20, No. 2, April 2005.
- [28] IEEE Recommended practice for evaluating electric power systems compatibility with electronic process equipment, Annex C, IEEE Std 1346-1998 (R2004).
- [29] S.Z. Djokic, J.J.M. Desmet , G. Vanalme, J.V. Milanovic and K. Stockman, Sensitivity of Personal Computers to Voltage Sags and Short Interruptions, *IEEE Transactions on Power Delivery*, Vol. 20, No. 1, January 2005, pp. 375-383.
- [30] P. Pohjanheimo and M. Lehtonen, Equipment sensitivity to voltage sags – test results for contactors, PCs and gas discharge lamps, *Proceedings of 10th International IEEE Conference on Harmonics and Quality of Power ICHQP 2002*, Vol. 2, pp. 559-563, Rio de Janeiro, October 2002.
- [31] M. Stephens, C. Thomas, T. Paudert, B. Moncrief, PLC Basics and Voltage Sag Susceptibilities – Part 1, *Power Quality Assurance*, January 2001.
- [32] M. Stephens, C. Thomas, T. Paudert, B. Moncrief, PLC Basics and Voltage Sag Susceptibilities – Part 2, *Power Quality Assurance*, February 2001.
- [33] IEEE recommended practice for evaluating electric power system compatibility with electronic process equipment, Annex C, IEEE Std 1346-1998 (R2004).
- [34] D.A.R. Lopes, E.D. de Jesus, L.A.F. Valle, Maintaining the continuity of process operations after voltage sag or power interruption, *IEEE Annual Petroleum and Chemical Industry Technical Conference*, pp. 81-86, 2004.
- [35] G. Brauner and C. Hennerbichler, Voltage dips and sensitivity of consumers in low voltage networks, *CIGRE 2001, IEE Conference Publication*, No 482, 2.31, Amsterdam, June 2001.
- [36] K. Stockman, M. Didden, F. D'hulster, R. Belmans' Embedded solutions to protect textile processes against voltage sags, *IEEE Industry Applications Magazine*, Vol. 10, No. 5, September/October 2004, pp. 59-65.
- [37] S. C. Vegunta and J. V. Milanovic, Investigation of Voltage Disturbances in a Typical Pharmaceutical Customer Facility, *CD Rom of the 16th Power Systems Computation Conference, PSCC'08*, Glasgow, Scotland, UK, July 14-18, 2008.
- [38] S. C. Vegunta, *Impact of voltage sags on continuous industrial processes*, PhD Thesis, The University of Manchester, Manchester, August 2008.

4 Characterisation and Compliance Testing of Equipment Immunity

4.1 Introduction

In this chapter, the information from Chapters 2 and 3 is used to select dip characteristics that should be considered when testing equipment for voltage dip immunity. Generally, the selection of relevant dip characteristics will depend on their influence on equipment dip sensitivity and objective of testing. *Compliance testing* is performed by a certified test laboratory to prove compliance of the equipment with international, national or industry standards. This requires a limited number of well-defined tests. *Characterisation testing* (also referred to as *immunity characterisation*) is aimed at obtaining more detailed information about the performance of the equipment when exposed to voltage dips. Characterisation testing should include more tests and test points—or their analytical equivalent—but place fewer requirements on the specific details of each test.

Characterisation testing is recommended as a way of exchanging information between the equipment manufacturer and the user of the equipment. Knowing the performance of the equipment when exposed to dips allows each user to choose the most appropriate equipment in an industrial installation.

In this chapter, *voltage dip immunity* refers to the ability of the equipment under test to continue to perform as intended during and immediately following the imposed voltage dip test condition.

4.2 Voltage dip characteristics

A detailed description of voltage dips and dip characteristics is given in Chapter 2, while a summary of those voltage dip characteristics with respect to their use in tests is reproduced in Table 4.4 at the end of this chapter. Each of these characteristics may influence the performance of equipment. To gain a full understanding of the performance of equipment for all voltage dips it would be necessary to consider all these characteristics as part of the testing. As this is not practical, a selection of these characteristics has to be made, e.g. based on their influence on equipment dip sensitivity (see Chapter 3).

4.3 Characterisation testing of equipment immunity

In this report, it has been determined that equipment voltage dip immunity should be described by one or more *voltage-tolerance curves* for dip magnitude and dip duration under conditions where the other dip characteristics are clearly specified or controlled. These voltage-tolerance curves are detailed in Sections 4.3.2 and 4.3.3. The inclusion of additional characteristics for testing was generally perceived as unnecessary, as it would greatly increase the number of combinations (i.e. test points) for which equipment need to be tested, without significantly increasing the accuracy of the user's decision on which equipment to use.

The error made by using only residual voltage and duration has been estimated for equipment sensitive to phase shift (phase angle jump) in Appendix 4.A of this chapter. Variations of both magnitude and phase angle unbalance are covered by using three general dip types introduced in Appendix 2.A of Chapter 2. The corresponding test vectors are presented in Section 4.5, and are assumed to be able to approximately represent these three dip types. A further discussion on testing of three-phase equipment is given in Appendix 4.B of this chapter.

4.3.1 The purpose of dip immunity characterisation testing

Dip immunity characterisation testing quantifies the relationship between the relevant characteristics of voltage dips *at the terminals of a device* and the continued operation and performance (as intended) of this device. For a particular installation, the resulting relationship—presented in the form of voltage-tolerance curves—can be used as a tool in assessing the compatibility between the equipment and the power supply.

A method for quantifying this compatibility is proposed in IEEE Std 493 [1] and IEEE Std 1346 [2]. The method combines the voltage-tolerance curve of a device with the (annual) voltage dip frequency contour chart of the local supply, resulting in the expected number of per-year equipment trips. This method only considers residual voltage and duration of voltage dips, while other dip characteristics are not considered.

In summary, selection of any test method for equipment dip immunity characterisation should be predicated on its ability to accurately assess the compatibility between the

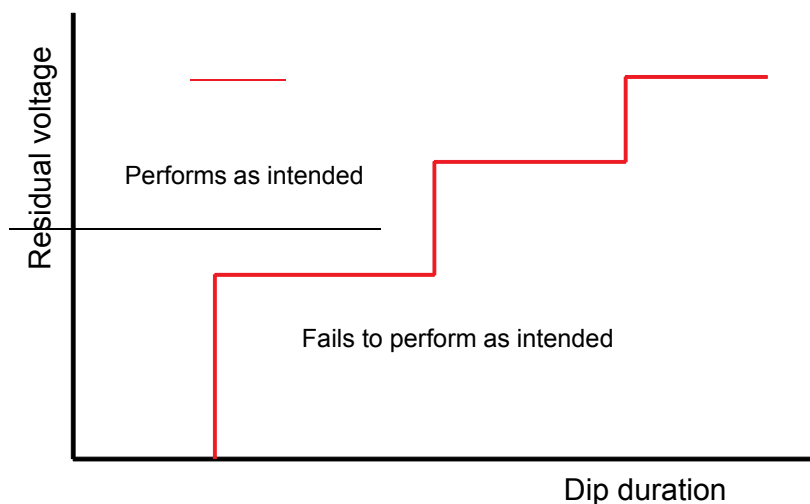

Figure 4-1 Example of voltage-tolerance curve.

In this report, the voltage-tolerance curve quantifies the actual performance of a piece of equipment or of an installation. This should not be confused with other curves or points that are sometimes drawn on the same axes to: (1) quantify performance *requirement* thresholds, such as the “Class A” curves depicted in Chapter 6 of this report, or (2) plot historical voltage dip events at a particular site.

The voltage-tolerance curve indicates for which combinations of dip magnitude (residual voltage) and dip duration the equipment will perform as intended. The equipment may fail to perform as intended only for dips with residual voltage and duration below the voltage-tolerance curve. The limitations of this approach are discussed in Section 4.3.4.

The equipment manufacturer (or in some cases equipment user) should specify what is meant by both “performs as intended” and “fail to perform as intended”, when providing characterisation test information.

4.3.3 Information required when presenting the voltage-tolerance curve

When characterising voltage dip immunity of equipment, it is recommended to give at least the voltage-tolerance curve under the conditions that follow. Voltage-tolerance curves characterising other conditions, when these conditions are known to affect equipment dip immunity, are encouraged.

Voltage-tolerance curves for both single-phase and three-phase equipment should:

- a. Be based on clear definitions of two main malfunction criteria: “performs as intended” and “fails to perform as intended”.
- b. Clearly indicate for which operating conditions the curve has been obtained. As a minimum (or standard) requirement, a curve for operation under normal or typical conditions (of load, temperature, humidity, pressure, process stage, etc.) should be provided.
- c. When testing equipment with adjustable set-points that can influence dip immunity, e.g., a motor drive DC bus “under-voltage trip” threshold, clearly indicate the set-points used if different from default values.
- d. The dips used for the characterisation testing should have zero phase shift for single-phase equipment. For three-phase equipment, the phase shift is defined by the test vectors (see Section 4.5).
- e. The dips used for characterisation testing of single-phase equipment should start at a voltage zero-crossing with positive gradient. For testing three-phase equipment, a consistent reference voltage should be chosen (typically, one phase-to-neutral or phase-to-phase voltage) and each dip should start at a zero-crossing of the reference voltage.
- f. The pre-dip and post-dip voltage waveform should be equal to rated voltage magnitude and rated frequency, with low harmonic distortion. Crest factor and total harmonic distortion of pre-dip and post-dip voltage waveforms during the test should be recorded.
- g. The dip magnitude should be constant during the dip period, i.e., the applied dip should have “rectangular” shape.
- h. The working group recognises that only a finite number of test points are practical. Equipment manufacturers are encouraged to provide a high resolution of the curve,

but at least the following values of residual voltage should be included: 0%, 40%, 50%, 60%, 70%, 80% and 85% of the nominal voltage. The voltage tolerance should further be indicated for a dip duration of 5 seconds¹.

- i. The uncertainty voltage magnitude for the test points mentioned in item h. should be at most $\pm 5\%$ of the adjusted residual voltage. The actual dip voltage should be measured and recorded with an accuracy of $\pm 1\%$.
- j. The duration for the test point mentioned in item h. should be a finite number of cycles of the power system frequency. The uncertainty should be less than 1 cycle for durations up to 1 second and $\pm 5\%$ or less for longer durations.
- k. On the voltage-tolerance curve, each test point should be clearly indicated. An approximate stepped curve joining these points should be given, as shown in Figure 4-1.
- l. The vertical scale should be given in volts or in percent of nominal voltage, with nominal voltage indicated in the test report.
- m. For equipment that can be used over a wide range of nominal voltage (e.g., 90–250 V or 340–460 V), the voltage-tolerance curve should be given for at least two values of the nominal voltage. The choice of values should be based on the nominal voltages for countries in which the equipment is intended to be used. In the case of 90–250 volt equipment, suitable values of pre-dip voltage are 120 V and 230 V.
- n. For three-phase equipment, it should be clearly indicated which set of test vectors has been used for testing with Type I and Type II dips (see Sections 4.5.3 and 4.5.4).

4.3.4 Limitations of the voltage-tolerance curve

The usefulness of the voltage-tolerance curve is based on two assumptions:

- If a dip with a certain residual voltage and duration causes the equipment to trip, another dip with the same (or less) residual voltage and the same (or longer) duration will also cause the equipment to trip.
- If a dip with a certain residual voltage and duration does not cause the equipment to trip, another dip with the same (or greater) residual voltage and the same (or briefer) duration will also not cause the equipment to trip.

¹ The immunity of the equipment against undervoltages of longer duration than five seconds will be of interest in many cases. However any recommendations on this are beyond the scope of this report.

This corresponds to the statement that the dip performance of the equipment is fully determined by the residual voltage and the duration of the dip under the given conditions, i.e., the other dip characteristics do not influence the equipment performance. It is further generally assumed that the voltage-tolerance curve is a continuous and non-decreasing curve.

In reality, the equipment dip performance is also influenced by other parameters, so that two dips with the same dip magnitude and duration (but with difference in some other relevant characteristic/parameter) may result in different equipment response. Sometimes, this is represented by introducing a transition area between the intended and unintended performance, also known as a “voltage tolerance band”. This approach is, however, not recommended in this report. Instead, it is recommended, where the influence of other dip characteristics is significant, to quantify these influences. The working group does not give any recommendations on how, in general, this influence should be presented and which additional tests should be performed. Further discussion is provided in the next section.

4.3.5 Additional dip characteristics

As is shown in Chapter 3, some equipment is sensitive to more than just residual voltage and duration. Two dips with the same residual voltage and duration may impact the device in a different way; i.e. one may result in tripping of the device, whereas the other may not, if other dip characteristics vary. See Chapter 3 for examples.

Although the working group is aware that additional information can be useful in specific situations, it also recognises a number of reasons for showing restraint in demanding additional information.

- a. As is shown in Appendix 4.A, the error made by neglecting the impact of additional characteristics is estimated to be small, even in case of equipment extremely sensitive to phase shift.
- b. The inclusion of other characteristics, beyond residual voltage and duration, would require novel methods for assessing the compatibility between equipment and supply. The way in which the impact of other characteristics on dip immunity is presented should also be specified in a method for assessing the compatibility. As neither of

these has been developed at the moment, the usefulness of additional information is perceived by the working group as limited.

- c. Most network operators have, at best, limited information, or no information, on dip characteristics other than residual voltage and duration, e.g., phase shift and point-on-wave. This is at least in part due to the lack of generally-accepted methods for quantifying influence of these additional characteristics on equipment dip immunity.
- d. Each other characteristic would add a new dimension to the description of voltage dips, multiplying the number of tests to be performed by a factor of two to ten, depending on the number of values for the new characteristic to be considered.

Based on this, the working group considers it sufficient to quantify equipment immunity by the voltage-tolerance curve based on dip magnitude and dip duration. In specific cases, more information may be needed, but this will require the development of a number of additional tools, as mentioned above.

4.3.6 Multiple dip events

The impact of multiple voltage dip events (two or more voltage dips occurring shortly after each other, for example, within a time period shorter than 1 minute) caused significant debate within the working group. There was a particular concern over the reported equipment damage due to multiple voltage dip or short interruption events. At this moment, however, there is a lack of information to make a recommendation on testing equipment to multiple dip events. It is considered that the following data is not readily available:

- The frequency of occurrence of multiple voltage dip events;
- The impact of multiple voltage dip events on equipment.

Due to the lack of this information, the working group has decided that it cannot recommend characterisation testing for multiple dip events. However, the group strongly recommends further work on this issue, where manufacturers should provide information on the impact of multiple events on their equipment and network operators should provide information on the occurrence of multiple events.

4.4 Characterisation testing of single-phase equipment dip immunity

Single-phase equipment is exposed to one voltage only, the voltage across the equipment terminals.² A single voltage-tolerance curve, representing the test conditions of Section 4.3, adequately describes for which combinations of dip magnitude (residual voltage) and duration the equipment will perform as intended.

4.5 Characterisation testing of three-phase equipment dip immunity

The performance of three-phase equipment is determined by three voltage vectors, which may be either phase-to-phase or phase-to-neutral.^{1, 3}

The key characteristics to be considered in characterisation testing of three-phase equipment dip immunity are dip magnitude (residual voltage), duration, and three-phase unbalance. The latter is quantified by using the classification of voltage dips as Type I, Type II, or Type III, as presented in Appendix 2.A of Chapter 2.

4.5.1 Voltage-tolerance curves

The working group recommends that the dip immunity of three-phase equipment be characterised by the voltage-tolerance curves for each of the three general types of dips, corresponding to the Types I, II and III.

Each of the three voltage-tolerance curves should be developed under the conditions stated in Section 4.3. The point-on-wave of dip initiation should correspond to the zero crossing in the reference voltage, and the manufacturer should specify which phase-to-phase or phase-to-neutral voltage was used as the reference voltage. The phase-angle jump is determined by the test vectors presented in the forthcoming sections.

In Chapter 2, different dip types have been defined using phase-to-neutral voltages. Where no neutral point is available, the Type III curves should be obtained by applying a

² In some cases, the equipment performance is also affected by the neutral-to-ground voltage, but this is not further considered in this report.

³ Three-phase star-connected equipment may include some single-phase components connected phase-to-phase, and other single-phase components connected phase-to-neutral. In this case, the equipment may be affected by six voltage vectors: three phase-to-phase vectors, and three phase-to-neutral vectors.

Type III dip to the phase-to-phase voltages; the Type I and Type II curves should be obtained by applying a Type II and Type I dips, respectively, to phase-to-phase voltages.

4.5.2 Dips types for characterisation testing of three-phase equipment

Table 4.1 shows the vector diagrams for the three types of dips introduced in Chapter 2. The table also gives the mathematical expressions for the three sets of test vectors, with E the nominal voltage (typically 1.0 per unit) and V the dip magnitude (residual voltage). These three combinations are referred to in Chapter 2 as with “no characteristic phase-angle jump.”

Table 4.1. The three dip types introduced to represent voltage magnitude and phase angle unbalance.

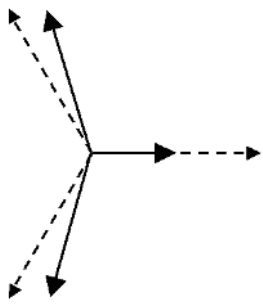
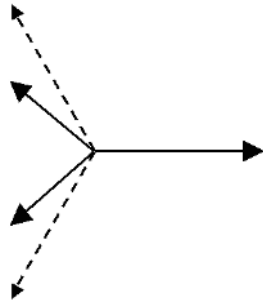
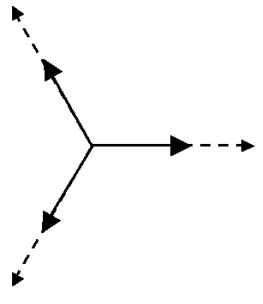
		
<p>Type I</p> $V_a = V$ $V_b = -\frac{1}{2}V - \frac{1}{2}jE\sqrt{3}$ $V_c = -\frac{1}{2}V + \frac{1}{2}jE\sqrt{3}$	<p>Type II</p> $V_a = E$ $V_b = -\frac{1}{2}E - \frac{1}{2}jV\sqrt{3}$ $V_c = -\frac{1}{2}E + \frac{1}{2}jV\sqrt{3}$	<p>Type III</p> $V_a = V$ $V_b = -\frac{1}{2}V - \frac{1}{2}jV\sqrt{3}$ $V_c = -\frac{1}{2}V + \frac{1}{2}jV\sqrt{3}$

The working group realised that it is not always practical to exactly reproduce the dips as represented in Table 4.1. In many cases, approximations need to be made to allow the use of available test equipment. This issue resulted in a series of discussions within the working group and, finally, consensus that the case could not be made for, or against, any of the methods described in this section. This is primarily due to the lack of information demonstrating that any of the methods is significantly less likely to accurately assess the equipment compatibility with the supply system.

Appendix 4.B, however, presents the framework for a mathematical approach to compare the different methods for their ability to accurately describe the compatibility between equipment and supply. Although this approach could not be implemented within the scope of the working group, researchers are encouraged to further investigate each test vector method for the compatibility assessment, preferably in cooperation with network operators and equipment manufacturers.

4.5.3 Test vectors for characterising response to Type I dips

Type I dips share the characteristic that one phase-to-neutral voltage has significantly lower dip magnitude than the two other phase-to-neutral voltages. For equipment with no neutral connection, Type I dips have two approximately equal phase-to-phase voltage magnitudes, which are significantly lower than the third phase-to-phase voltage. Equations in Table 4.1 for Type II dip should be applied to the phase-to-phase voltages. The definition in Table 4.1 includes both phase shift (but not characteristic phase angle jump) and dip magnitude.

The IEC basic standards 61000-4-11 and 61000-4-34 for voltage dip *compliance* testing (see Section 4.7) prescribe an alternative set of voltage vectors to test equipment against dips similar to Type I [3, 4]. This set of test vectors and its mathematical representation are shown in Table 4.2 (also referred to in Chapter 6 as “Type 3A”).

Table 4.2. IEC compliance test vectors representing Type I dips.

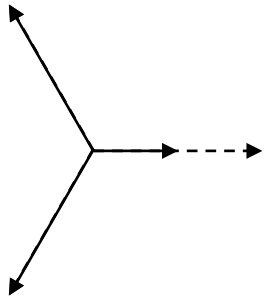
	$V_a = X$ $V_b = -\frac{1}{2}E - \frac{1}{2}jE\sqrt{3}$ $V_c = -\frac{1}{2}E + \frac{1}{2}jE\sqrt{3}$
---	---

In the mathematical notation, E is the nominal phase-to-neutral voltage and X is the residual phase-to-neutral voltage. A different symbol is used in Table 4.2 for the residual voltage than in Table 4.1. This is done intentionally, to emphasise the fact that the two test vectors for Type I dips cannot be directly compared. Consequently, they may have a

different impact on the same piece of equipment, and a voltage-tolerance curve based on the test vectors in Table 4.1 may be different from a curve based on the IEC test vectors in Table 4.2. It is thus important to indicate which set of test vectors has been used to obtain particular voltage-tolerance curve.

It is not possible to translate the residual voltage V in Table 4.1 into a residual voltage X for use in Table 4.2. This depends on the dip characteristic that causes the equipment trips. When equipment trips on the lowest phase-to-neutral voltage magnitude, the two sets of test vectors will give identical results. But, for example, when the equipment trips on the positive-sequence voltage, the two sets of test vectors will give different results. When the equipment trip is caused by an increased current at the end of the dip, the two sets of test vectors may or may not give similar results.

Regarding the testing of three-phase equipment to Type I dips, the working group acknowledges the test vectors shown in Table 4.1 as being representative of a majority of recorded Type I dips. There is insufficient data to establish whether the use of the alternative Type I dip test vectors from Table 4.32 will result in significant differences in assessed equipment dip immunity. Therefore the working group encourages further work in this area. Based on the available information, the working group recommends the use of the test vectors from Table 4.1, but allows using alternative test vector from Table 4.32. In any case, the Type I dip representation used for each test should be indicated.

4.5.4 Test vectors for characterising response to Type II dips

Type II dips share the characteristic that two phase-to-neutral voltages have approximately equal and significantly lower voltage magnitude than the third phase-to-neutral voltage. For equipment with no neutral connection, Type II dips have one phase-to-phase voltage magnitude significantly lower than the other two phase-to-phase voltages, and equations for Type I from Table 4.1 should be applied in this case. The definition in Table 4.1 includes both phase shift (but not characteristic phase angle jump) and dip magnitude.

The IEC basic standards on voltage dip immunity compliance testing [3, 4] allow either of two sets of Type II test vectors: the one shown in Table 4.1 (referred to in Chapter 6 as Type 3C) and the one shown in column (a) in Table 4.3 below (referred to in Chapter 6 as Type 3B). The test vectors shown in column (b) of Table 4.3 are not allowed according to

the IEC basic standards. Both methods in Table 4.3 have limitations: method (b) includes no phase shift, yet applies the most severe drops in magnitude; method (a) imposes excessive phase shift⁴ for dip magnitudes less than 50%. As mentioned before, the working group does not have sufficient information to argue for, or against, any of these methods.

The working group recognises the vectors shown in Table 4.1 as being representative of most recorded dips and of the known system response to faults on the network. Nevertheless, there is insufficient data to establish whether using the alternative dip test vectors in Table 4.3 would result in markedly superior or inferior equipment immunity, and it is recommended that further work be performed to investigate this issue. With the present state of knowledge, the working group recommends the use of the test vectors in Table 4.1, but allows using alternative test vector from Table 4.3. In any case, the dip representation used for each test should be indicated.

Table 4.3. Alternative test vectors for characterising response of three-phase equipment to Type II dips.

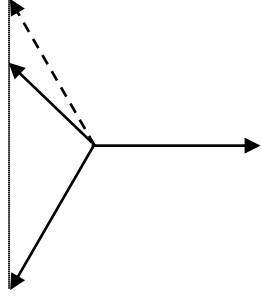
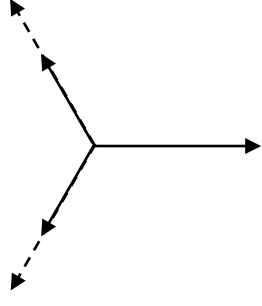
(a) IEC “acceptable method 1”	(b) IEC “not acceptable method”
	
$V_a = E$ $V_b = -\frac{1}{2}E - \frac{1}{2}jE\sqrt{3}$ $V_c = -\frac{1}{2}E + \frac{1}{2}j(2X - E)\sqrt{3}$	$V_a = E$ $V_b = -\frac{1}{2}X - \frac{1}{2}jX\sqrt{3}$ $V_c = -\frac{1}{2}X + \frac{1}{2}jX\sqrt{3}$

⁴ According to information provided by one of the working-group members, this has been introduced intentionally to be able to test certain loads, like phase-rotation relays, that are known to be highly sensitive to phase shift.

4.5.5 Test vectors for characterising response of three-phase equipment to Type III dips

For Type III dips, set of test vectors shown in Table 4.1 should be used. If a system neutral conductor is not available, the equivalent dip magnitude should be applied to the three phase-to-phase voltages.

4.6 Characterisation testing of equipment dip immunity – summary

4.6.1 Single-phase equipment

For characterising dip immunity of single-phase equipment, one voltage-tolerance curve based solely on the dip magnitude (residual voltage) and duration should be used. No other dip characteristics need to be considered

4.6.2 Three-phase equipment

For characterising dip immunity of three-phase equipment, voltage-tolerance curves should be given for three general dip types: Type I, Type II and Type III dips. For the representation of these three general dip types, the test vectors in Table 4.1 are recommended, but test vectors from Table 4.2 and Table 4.3 are also allowed, due to the lack of information against their use. Further research in this area is strongly encouraged.

4.7 Compliance testing of equipment dip immunity

Compliance testing is the testing of equipment against the criteria defined in equipment immunity standards. The outcome from compliance testing is: either the equipment under the test passes the required criteria and is compliant, or it fails and is non-compliant.

Detailed testing protocols, test conditions and characteristics must be prescribed for compliance testing. Immunity standards for compliance testing can be industry standards, e.g., SEMI F47, national standards, or international standards, e.g., IEC or IEEE standards. These standards describe the test protocol in significant detail, and therefore try to limit the number of dip magnitude-duration combinations used in tests.

4.7.1 Compliance testing of single-phase equipment dip immunity

For single-phase equipment, the dip characteristics recommended for compliance testing are dip magnitude (residual voltage) and duration, with the equipment under test exposed to a limited number of combinations of dip magnitude and duration. Recommendations and comparisons with existing IEC standards are given in Chapter 7.

4.7.2 Compliance testing of three-phase equipment dip immunity

For three-phase equipment, the dip characteristics recommended for compliance testing are dip magnitude (residual voltage), duration, and (three-phase) dip type (Type I, Type II and Type III, as introduced in Chapter 2 and discussed in Section 4.5). Recommendations and comparisons with existing IEC standards are given in Chapter 7

As discussed in Chapter 7, compliance testing should include all three dip types. To represent the three dip types, the test vectors in Table 4.1 are recommended, but alternative test vectors shown in Table 4.2 and Table 4.3 may be also used. The statistical data gathered in Chapter 6 has shown that a significant number of dips are of Type III. The working group recommends that compliance testing should include all three dip types. However, without the information on the economic consequences of the inclusion of Type III dips in the compliance testing, no recommendations are given about the form in which Type III dips should be applied in the compliance testing.

4.7.3 Existing IEC dip compliance standards

The existing international voltage dip immunity standards for compliance testing are IEC 61000-4-11 and IEC 61000-4-34. The basic testing protocol, test conditions, and characteristics of dips used in the tests are prescribed in IEC 61000-4-11 for equipment with rated/input current up to 16 A [3], and in IEC 61000-4-34 for equipment with rated/input current greater than 16 A [4], covering both single-phase and three-phase equipment. Although the actual tests are prescribed in the product standards, and may deviate from those in the basic standards, in practice, the product standards follow the basic standards.

The existing IEC dip immunity standards do not require Type III dips to be included in tests. After the working group analysed the statistical data on the occurrence of voltage

dips (see Chapter 6), this indicated that the frequency of Type III dips is significant, and that further work is required to improve our understanding of the impact of Type III dips on equipment and to develop appropriate test procedures. In addition, further work is required to determine the benefits of using alternative test vectors defined in Table 4.1 and 4.3, when compared with those defined in the current IEC basic standards.

4.8 Conclusions

This chapter has introduced two distinctive concepts of equipment dip immunity tests: characterisation testing and compliance testing. Presented in the form of voltage-tolerance curves, characterisation test results can be communicated from equipment manufacturers to users, and provide a tool that equipment users may use to assess the expected number of times that equipment will trip at a facility or an installation site.

The suggested testing procedures include only variations in dip magnitude (residual voltage) and in dip duration. No significant benefit is seen in performing additional tests covering other dip characteristics, such as phase shift and point-on-wave.

For characterisation testing of three-phase equipment, the working group recommends that the dip immunity of equipment is represented by the voltage-tolerance curves for each of three general types of dips (Types I, II and III). Where it is not practical to reproduce the unbalanced voltage dip vectors given in Table 4.1, it is acceptable to allow the alternative test vectors (given in Tables 4.2 and 4.3) for testing of three-phase equipment.

For compliance testing of three-phase equipment, it is recommended to include tests for Type I, Type II and Type III dips. No recommendations have been given about the procedure which should include Type III dips in the compliance testing.

The list of dip characteristics introduced in Chapter 2 is reproduced in Table 4.4, together with the recommendations from the working group for equipment testing. The recommendations hold for both compliance testing and for characterisation testing. The difference is in the number of test points and the detailed specification of the tests.

Table 4.4. Voltage dip characteristics for testing of equipment.

VOLTAGE DIP CHARACTERISTIC	RECOMMENDATION
Pre-event segment	
Characteristics of the pre-event segment	Nominal voltage, with low distortion
During-event segment	
Dip magnitude	Test variable (vertical axis)
Dip duration	Test variable (horizontal axis)
Dip shape	Rectangular
Dip voltage magnitude unbalance	Test for each case: Type I, Type II, and Type III ⁵
Dip phase angle unbalance	Test for each case: Type I, Type II, and Type III ³
Dip phase shift (phase-angle jump)	None for single-phase equipment tests. For three-phase equipment, test for each case: Type I, Type II, and Type III ³
Dip waveform distortion and transients	Test waveform should have low distortion
Transition segment	
Dip initiation	Not specified
Point-on-wave of dip initiation	Voltage zero-crossing of the reference voltage (choose one of the phase-to-neutral or phase-to-phase voltages as the reference).
Phase shift at the dip initiation	None for single-phase equipment tests. For three-phase equipment, test for each case: Type I, Type II, and Type III ³
Multistage dip initiation	Not tested
Dip ending	Not specified
Point-on-wave of dip ending	Not specified: determined by dip duration and point on wave of initiation
Phase shift at the dip ending	Not specified: determined by phase shift at dip initiation (the two should cancel each other)
Multistage dip ending	Not tested
Rate-of-change of voltage	Not tested or specified
Damped oscillations	Not tested
Voltage recovery (post-event) segment	
Voltage recovery	Immediate
Post-fault dip (prolonged voltage recovery)	Not tested
Post-dip phase shift	None
Multiple dip events (dip sequences)	Not tested
Composite dip events	Not tested

4.9 References

- [1] IEEE Std 493-2007, IEEE Recommended Practice for the Design of Reliable Industrial and Commercial Power Systems.
- [2] IEEE Std 1346-1998, IEEE Recommended Practice for Evaluating Electric Power System Compatibility With Electronic Process Equipment.

⁵ For compliance testing, the working group makes no recommendations as to form of Type III dips

[3] IEC 61000-4-11, Electromagnetic compatibility (EMC) - Part 4-11: Testing and measurement techniques - Voltage dips, short interruptions and voltage variations immunity tests, Edition 2.0.

[4] IEC 61000-4-34, Electromagnetic compatibility (EMC) - Part 4-34: Testing and measurement techniques - Voltage dips, short interruptions and voltage variations immunity tests for equipment with input current more than 16 A per phase, Edition 1.0.

Appendix 4.A: Phase-angle jumps and dip immunity testing

The working group discussed at length the need to require voltage-tolerance testing of equipment for different values of the phase-angle jump. However it is recognised that inclusion of this information could greatly increase the number of tests that are needed. Therefore, the following evaluation has been done to assess the consequences of ignoring the impact of the phase-angle jump on the voltage-tolerance curve.

The aim of the voltage-tolerance curve is to provide the equipment user with information on equipment immunity. Together with information on the number of dips per year that occur at the equipment terminals (i.e., the system dip performance), the user can calculate how often the equipment can be expected to fail to operate as intended due to voltage dips. For the remainder of this appendix, “trip” is used synonymously with “fail to operate as intended.”

The two cases to be compared are: the calculated number of trips per year when the voltage tolerance is not impacted by the phase-angle jump; and the number of trips when the impact of the phase-angle jump is considered.

Consider the voltage-tolerance curve, voltage magnitude versus duration, of Figure 4-2.

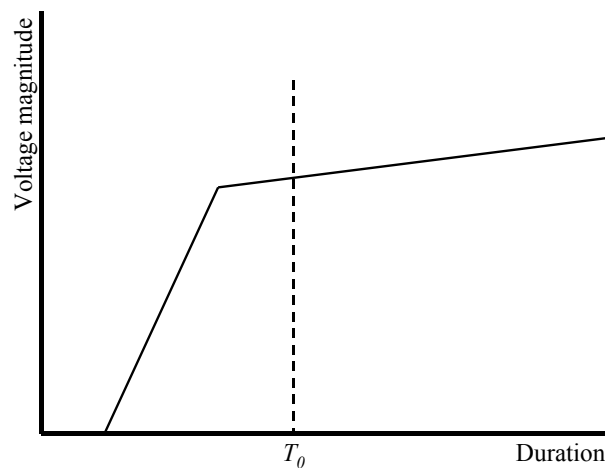

Figure 4-2. A voltage-tolerance curve.

Adding a third dimension, for example phase-angle jump, will result in a "voltage-tolerance surface". Taking a cross-section of this surface for a fixed value of the dip duration, for example T_0 in the figure above, results in a curve of voltage versus phase-angle jump as shown in Figure 4-3.

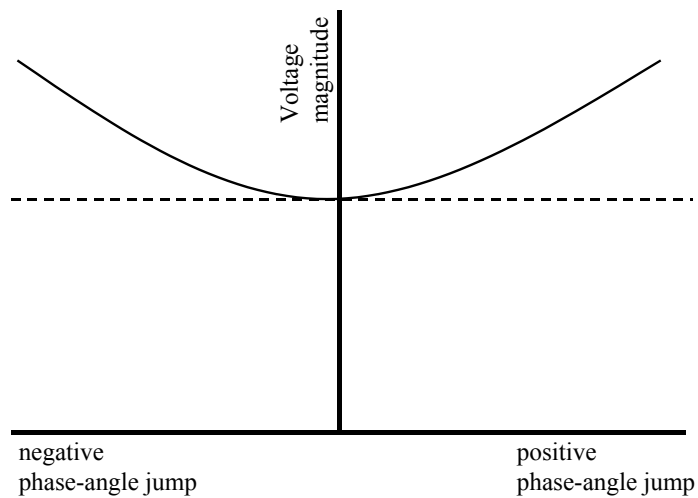

Figure 4-3. Voltage tolerance versus phase-angle jump.

Any dip, of duration T_0 , with magnitude and phase-angle jump below the solid curve will cause equipment to trip. The dashed curve represents the approximation made when neglecting the impact of the phase-angle jump on the equipment immunity. This approximation limits the ability to predict the compatibility between equipment and supply (see Section 4.3.1). It will result in an error in the predicted number of equipment trips. This error is equal to the number of dips between the solid and the dashed curve.

In reality, both curves are a cross-section of a voltage-tolerance surface, and the error made in using one or the other is the number of dips between these two surfaces. Calculating this error requires information on:

- The number of dips as a function of magnitude, duration and phase-angle jump;
- The shape of the voltage-tolerance surface.

We have made assumptions based on our experiences, with the aim to estimate the error so as to be able to decide if the magnitude versus duration voltage-tolerance curve approximation is acceptable.

Consider one value of the dip duration, 6 cycles, for which data is available. We assume that magnitude, duration, and phase-angle jump are independent, which allows us to use existing data.

We further use a hypothetical worst-case example derived from testing performed by EPRI⁶ on the impact of the phase-angle jump on the voltage tolerance, as shown in Figure 4-4.

⁶ The effects of phase shift on low-voltage tolerance of industrial process devices, EPRI Power Quality Test Network, Brief 45, June 1998.

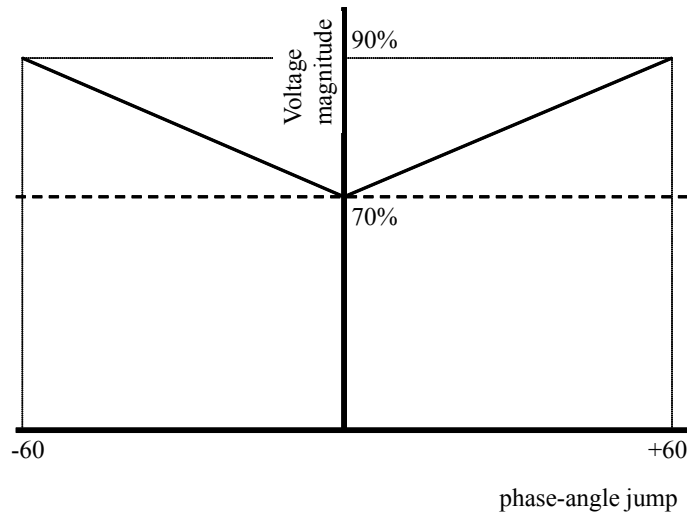

Figure 4-4. A hypothetical worst-case example of voltage tolerance versus phase-angle jump.

The relation between minimum voltage V and phase-angle jump ϕ is given by

$$V(\phi) = 70 + \frac{1}{3}|\phi| \quad (1)$$

We assume further that the number of dips with residual voltage below V (in per-unit) is proportional to the ratio $\frac{V}{1-V}$. The proportionality factor is strongly location dependent. Here we assume a proportionality factor equal to 1. In the end it will be evident that only the relative difference is important.

The number of dips below 70% (the dashed curve) is $\frac{70}{100-70} = 2.33$. The number of dips below the solid curve is:

$$N_V = \frac{70 + \frac{1}{3}|\phi|}{30 - \frac{1}{3}|\phi|} \quad (2)$$

Statistics on the number of dips with different phase-angle jump are given in the EPRI report TR-112692⁷. The range of phase-angle jump is between -45 and +45 degrees.

The total number of dips between the solid and the dashed curve, (i.e., the error made) is:

$$\varepsilon = \sum_{\phi=-45}^{+45} \frac{70 + \frac{1}{3}|\phi|}{30 - \frac{1}{3}|\phi|} \times N_{\phi} - 2.33 \quad (3)$$

⁷ Waveform characteristics of voltage sags - statistical analysis, EPRI report TR-112692, April 1999.

where N_ϕ represents the fraction of dips with phase-angle jump ϕ .

The results of the calculations are summarised in the table below, where the first column gives the phase-angle jump in degrees; the second column gives the number of dips per year below the solid curve according to (2); the third column gives the fraction of dips with this phase-angle jump; and the absolute error in the number of dips per year according to (3).

ϕ	N_V	N_ϕ	\square
-45	5.67	0.005	0.0167
-40	5.00	0.01	0.0267
-35	4.45	0.015	0.0318
-30	4.00	0.02	0.0334
-25	3.62	0.025	0.0323
-20	3.29	0.03	0.0288
-15	3.00	0.06	0.0402
-10	2.75	0.16	0.0672
-5	2.53	0.36	0.0720
0	2.33	0.30	0
+5	2.53	0.03	0.0060
+10	2.75	0.01	0.0042
+15	3.00	0.01	0.0067
+20	3.29	0.005	0.0048
+25	3.62	0.003	0.0039
+30	4.00	0.002	0.0033

The sum of the error values in the last column is 0.3780.

The results may be summarised as:

- Including the impact of phase-angle jump gives: 2.71 events per year
- Neglecting this impact gives: 2.33 events per year
- The error is: 16%

Considering that:

- a. this is a worst-case situation,
- b. there are also other uncertainties in the voltage tolerance, and
- c. the supply dip performance is estimated/assessed with similar or even larger errors,

it is concluded that there is, in general, no need to ask a manufacturer to provide the data on the influence of the phase-angle jump on the voltage tolerance. A curve for zero phase-angle jump will be sufficient.

In this appendix only single-phase equipment has been considered, due to lack of data and a clear definition of phase-angle jump in a three-phase system. Consequently it is not recommended that phase-angle jump information is sought from the manufacturers of three-phase equipment.

Appendix 4.B. Testing of three-phase equipment dip immunity

The subject of testing three-phase equipment against voltage dips has been discussed in significant detail during and between the working-group meetings. These discussions did not, however, result in an unambiguous conclusion. This appendix is intended to frame the subject in a systematic way, so that requirements for further study will become clearer. The working group encourages further research on this subject.

Different types of dips for dip immunity assessment of three-phase equipment

In Appendix 2.A of Chapter 2, three basic types of dips for three-phase equipment have been defined.

- Type I: the main reduction in magnitude is in one of the three phase-to-neutral voltages;
- Type II: the main reduction in magnitude is in two of the three phase-to-neutral voltages;
- Type III: all three phase-to-neutral voltages show about an equal reduction in magnitude.

In most immunity test standards, only Type I and/or Type II dips are applied to the equipment terminals. There are several reasons for this: testing for Type III dips would make the test equipment, and thereby the test procedure, more expensive; making three-phase equipment to tolerate Type III dips will require more investment than making it to tolerate Type I and Type II dips only; the number of Type III dips is much smaller than the number of Type I and Type II dips. With the data and information presently available to the working group, only the third aspect can be verified. If further research shows that the number of Type III dips is a significant fraction of all dips, the decision to not test against Type III dips may be reconsidered. In this appendix, a possible approach is presented to assist in this decision.

Consider for simplicity a one-dimensional situation, where the impact of dips on equipment only depends on the residual voltage, where we assume that an appropriate definition of residual voltage exists. The number of dips as a function of the residual voltage, i.e., the number of dips with residual voltage less than or equal to the indicated value, is shown in Figure 4-5. The number of Type III dips is less than the number of Type I and Type II dips.

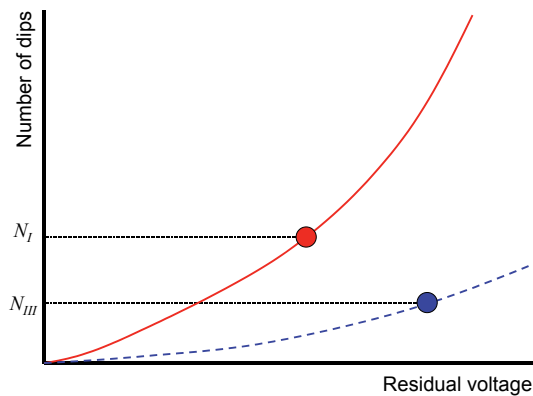

Figure 4-5. The number of dips as a function of the residual voltage: Type I and Type II (red solid curve) and Type III (blue dashed curve).

Of interest to the end-user is, however, not the number of voltage dips but the number of equipment or process trips. The tolerance of equipment is not the same for the different types of dips. We assume that the tolerance is the same for Type I as for Type II dips, as the same requirements are placed on these two dip types. The red circle (on the red solid curve) indicates the voltage tolerance for Type I and Type II dips; the number of trips due to Type I dips is thus equal to N_I . Equipment is normally more sensitive to Type III dips, as indicated by the blue circle (on the blue dashed curve): the number of trips due to Type III dips is equal to N_{III} . Dips of Type III do not need to be considered during testing when:

$$N_{III} \ll N_I$$

(Note: this is a necessary condition, not a sufficient condition. The above-mentioned economics still hold.)

In the figure, only the residual voltage is shown; the same reasoning is possible in two dimensions considering the voltage-tolerance curve of residual voltage and duration.

Once the voltage-tolerance curves of the equipment are known (for the three dip types) and statistical information is available on the number of dips (again, for the three dip types) the above assessment can be made. However, the voltage-tolerance curves differ between equipment and it is not known how voltage tolerance performance for Type I and Type II dips correlates with performance for Type III dips.

The following is a first estimation: As a worst case it can be assumed that equipment trips for any Type III dip with a residual voltage below 85% of nominal. Using the statistical information obtained in Chapter 5, it can be estimated how many trips due to Type III dips can be expected at the global 50%, 75%, 90% and 95% sites. Those numbers can be compared for the number of dips of Type I and Type II that are below the requirements.

We can then estimate Type III requirements: If it is concluded from the first estimation that equipment trips due to Type III dips for a significant part of the total number of trips; the next step would be to propose

requirements for the tolerance of equipment against Type III dips. Those might be obtained from the following requirement:

$$N_{III} < 0.2 \times N_I$$

The number of trips due to Type III dips should not be more than 20% of the number of trips due to Type I and Type II dips together. The factor (0.2) is an open point of discussion.

Test vectors for Type I and Type II dips

Requirements exist in standard documents for the tolerance of equipment against Type I and Type II dips. However the prescribed tests use voltages (magnitude and phase angle) that are different from those that occur in reality. This deviation between test vectors and reality is generally recognised and accepted. To understand this it should be noted that, as discussed in Chapter 2, there exists an enormous variety of voltage dips in the real world. Covering such a large number of possible dips during regular equipment testing is obviously not a practical situation⁸. There is, however, no agreement about which test vectors to use. One school of thought wants the test vectors as close as possible to the most typical dips as they occur in reality. Another school of thought is in favour of test vectors that allow for less expensive test equipment, while still representing some of the characteristics of real-world dips.

Let us again consider a simplified situation where dips can be described by two parameters. (Note: seven parameters describe the three test vectors, assuming that only magnitude, phase angle, and duration matter. Considering only dips with no zero-sequence voltage reduces this to five parameters.) One of the parameters, the one being varied during testing, is referred to as "residual voltage." As before, we assume that an appropriate definition exists. This simplified situation is illustrated in Figure 4-6.

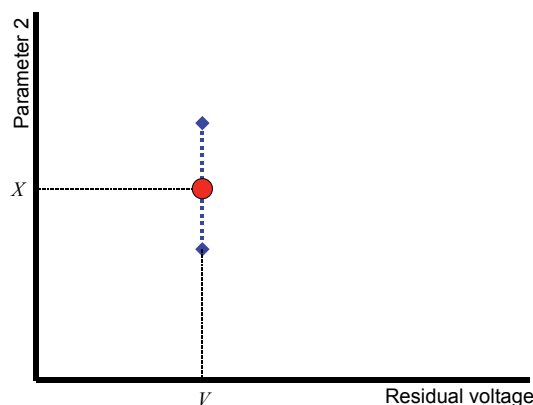

Figure 4-6. Range in a voltage dip parameter for real-world dips compared to the value for dips used for testing.

⁸ For research purposes or during the development of equipment it may however be decided to perform such a large number of tests; the summary of voltage dip characteristics in Chapter 2 can be used as a basis for such testing.

A set of test vectors with residual voltage V is chosen, as prescribed in a testing standard. The test vectors are defined in such a way that the choice of residual voltage fully defines the dip; in other words, all other parameters are fixed once the residual voltage has been chosen. In this example, a residual voltage V corresponds, for the test vectors, in a value X for parameter 2. In reality a range of values occurs for parameter 2, even when the residual voltage is fixed. The vertical (blue dotted) bar in the figure indicates this. The red circle indicates the test vector.

To summarise the situation, the blue vertical bar in the figure indicates the range in parameter 2 values for real-world dips when the residual voltage has been fixed to V . The red dot indicates the value of parameter 2 that is used for testing. The difference in two approaches can be explained as follows:

- One school of thought is that the red dot should be in the centre of the blue bar, as this minimises the error made. We leave it for now out of the discussion where this "centre" actually is. In a statistical sense, a probability distribution function of parameter 2 should be considered; the expected value of parameter 2 may be an appropriate choice, under this first school of thought.
- Another school of thought is that the costs of the testing equipment should also be considered and that the red dot may be away from the centre of the blue bar.

The approach for assessing different test vectors should proceed in the same way as the one used for phase-angle jumps. The impact of the different parameters on the voltage tolerance should be considered as well as the spread in those parameters for real-world voltage dips. With the data available in Chapter 5 it is possible to calculate the spread in each of the parameters for real-world dips. However data on the impact of these parameters on equipment performance is much harder to acquire. It would require detailed testing or simulation of several different types of equipment. The working group would like to present this issue as a task for future research.

5 Economics of Voltage Dip Immunity

5.1 Introduction

From a technical point of view, all equipment can be designed so that it is completely immune to voltage dips. This complete immunity, however, would come at substantial cost, and most equipment might become "too immune" for typical disturbances and common areas of application.

For example, an investment in designing and manufacturing an adjustable speed drive (ASD) that is highly immune to voltage dips would probably not be justified if the ASD is operating an air-handling fan. However, if the ASD is to handle expensive and delicate silicon wafers in a semiconductor factory, the investment might well be justified. Accordingly, the additional cost of the immunity must be evaluated against the economic consequences due to lack of immunity. Therefore, selection of adequate voltage dip immunity levels is mostly an economic decision.

For each piece of sensitive equipment, an individual end-user should balance the higher price that needs to be paid for higher immunity against the potential financial loss incurred due to a failure or malfunction of less resilient equipment caused by voltage dips.

In contrast, for mandatory voltage dip immunity standards, the decision is essentially how much more should all end-users who buy particular equipment be required to pay for the increased immunity of that equipment, keeping in mind that, for large number of applications, voltage dips might not be an issue in the first place.

This chapter addresses in some detail the main factors that influence decisions about the investment in increased immunity of equipment.

5.2 Data needed to set voltage dip immunity requirements

Optimal decisions regarding investment in increased equipment immunity are influenced by the following factors:

- the number and characteristics of voltage dips experienced at the equipment terminals;
- the link between characteristics of experienced dips and the industrial process or service interruption, or other adverse impact on the end-user;
- the financial loss resulting from industrial process or service interruption, or other adverse impact on the end-user;
- the costs of increasing equipment immunity to voltage dips.

Each of these factors and possible methods to quantify them are discussed in more detail below.

5.3 Number and characteristics of voltage dips

To estimate a typical number and typical characteristics of voltage dips at equipment terminals, the information on frequency of occurrence and type of voltage dips at those terminals should be collected from available dip monitoring data. If there is no monitoring data at equipment terminals, voltage dip statistics at the service entrance of the facility where the equipment is located can be used, or even the information about voltage dips in the local network. In this case, further analysis or extrapolations would be required to get the information about dip performance at equipment terminals, as dip characteristics change during propagation through local distribution network.

Dip monitoring cannot be performed at all buses of interest in the network due to both technical and financial constraints, and further processing of available dip data is usually necessary. This might include extrapolation of the data to cover “non-monitored” buses, or some additional computer simulations to trace dip propagation from monitored buses to bus of interest. The frequency and characteristics of voltage dips are influenced by many external factors: network design (meshed or radial, overhead or cable lines), earthing practices (high impedance or solidly earthed), transformer winding connections and equipment connections (single-phase or three-phase). Further details on estimation of the frequency and characteristic of voltage dips can be found elsewhere, e.g., in the CIGRE WG C4.1.02 report [1], or in [2-10].

If no other data is available, a reasonable first-level approximation would be to use the data presented in this report (see dip performance charts in Chapter 6). This information is based on extensive and long-term dip monitoring data from power networks around the world.

5.4 Financial loss resulting from equipment failure or malfunction

5.4.1. Equipment failure or malfunction

The crucial step for the economic assessment of voltage dips requires information about the consequences of expected voltage dips on the performance of the connected process.

In order to determine whether the equipment will trip/malfunction or ride-through a dip of a specified type, magnitude and duration, the expected voltage dips are compared with the sensitivity of process equipment connected at a given bus. This procedure requires preparing a dip performance chart for a particular bus in the system, and coordination of equipment responses with these voltage dips on a single graphic display. For this purpose, precise information about the equipment/process sensitivity is required for accurate quantification of the failures due to voltage dips. The information about the equipment sensitivity may be gathered from the equipment manufacturer, or by testing. Testing of every piece of equipment is neither justifiable nor possible. Therefore, sensitive industrial equipment may be classified into various categories, based on equipment types, and then the testing can be performed on a suitable sample of equipment chosen randomly from each category. It should be noted, however, that even though different equipment may belong to the same equipment category, they may not exhibit the same sensitivity to voltage dips. This

makes it difficult to develop a single generic standard that defines the sensitivity of process equipment.

In the general case, a process may be disrupted due to the tripping of individual equipment items, or a group of equipment, depending upon their interconnections. Therefore, for any assessment of financial losses incurred in a customer facility due to voltage dips, the precise counting of process disruptions (not individual equipment trips) is essential. The probabilistic assessment of the number of process disruptions should incorporate the uncertainty associated with the equipment sensitivity, as well as the uncertainty associated with the interdependencies of equipment involved in the process. The only satisfactory way to deal with these uncertainties is to apply probabilistic calculations relying on expert advice and a limited number of field/laboratory tests related to equipment or process sensitivity to voltage dips.

The factors that influence equipment sensitivity to voltage supply disturbances can be classified in three general categories with respect to their nature and origin:

- i) Voltage supply related electrical characteristics;
- ii) Equipment specific electrical characteristics;
- iii) Other, non-electrical characteristics.

Detailed discussion of these factors can be found in [11].

This section deals primarily with the subset of above mentioned characteristics that, following an assessment, are considered to have a significant impact on equipment sensitivity. Further details on sensitivity of different types of equipment to voltage dips can be found in Chapter 3 of this report.

In summary, the reasons for failure of equipment during voltage dips can be classified as below.

- Lack-of-energy related failures.
- Voltage dip sensing (undervoltage) induced failures.
- Increased current (overcurrent) induced failures
 - Increased current on unaffected phases (non-dipped phases), typically in constant-power loads such as modern ASDs.
 - Increased current during unbalanced dips due to the presence of negative- and zero-sequence components, typically in motor loads.
 - Increased current immediately after the ending of a dip, typically for re-charging bulk storage capacitors in dc power supplies and voltage dip mitigating devices. For an integrated process, this may include the simultaneous reacceleration or re-energising of a number of plant items.

5.4.2 Financial consequences of equipment failure

There are numerous factors that can affect the total cost of downtime (COD) when a process is disrupted by equipment failure or malfunction due to voltage dips. Some of these factors are industry-specific, region-specific or location-specific. A summary of the key factors is briefly discussed below. For further information on assessment of financial losses due to voltage dips, including an overview of reported losses, please refer to the report of CIGRE/CIREN JWG C4.1.07 or [12].

i) Direct Costs

Production cost, manufacturing cost and direct cost are terms used interchangeably in the literature, usually referring to cost of manufacturing a finished product. In the COD context, direct cost refers to production cost accrual at a given instance of disturbance, and is, therefore, a function of time and process activity. Most manufacturing sectors include the following direct cost components: raw material cost, energy cost, labour cost, overhead cost, outage savings, profit loss, etc. A brief discussion of these cost components is presented below.

Raw Material

Disruption of a manufacturing process, whether partial or complete, can cause wastage of significant amount of raw material (usually referred as scrap), some savings of the raw material that would be otherwise used for manufacturing a finished product, and additional use of raw material for recycling affected/damaged product. Product damage is not always observable. When it is hidden, product damage can be costly, especially if the damage is subtle and the effects take time to surface [13]. Additionally, high frequency of experienced disturbances will increase the burden on manufacturers to store excess raw material, leading to the increase in warehouse use, space, storage and maintenance cost.

Energy

Although electrical energy is most commonly used among industrial sectors to power/run the process, other forms of energy consumption, such as steam, gas, coal, etc., are also widely used. Product damage energy cost is a sum of plant's base energy usage (e.g. lighting, PCs, etc.) and progressive production related energy consumption cost up to the point of plant disruption leading to downtime or product damage [13]

Labour

As an element of direct cost, the labour cost usually refers to the workforce payments associated with the product until the point when process disruption occurs. When overtime labour is available or production capacity is not fully used, the lost production may be recovered at a relatively small cost.

Overhead

Overhead cost includes marketing and sales cost, administrative cost, annual plant maintenance cost (e.g. equipment repair due to wear and tear, consultants and electrical contractors, etc.), and site service cost. Overhead costs are part of the indirect cost, and does not include the disturbance-related repair or damage, or

restart costs, which are treated as the separate costs in this report.

Lost Opportunity

Process disruption may lead to interrupted sales or severely impacted revenue flow, resulting in delayed production schedules [13, 14]. These costs are usually readily identifiable or observable costs.

Penalties

Occasionally, process disruption and damaged products can cause companies to be penalised commercially, e.g. for not delivering the order within the contract timescales. In some cases, this might even upset the financial market perception of the company and damage its reputation. For example, one large memory chip-maker reported that it could incur a multimillion (US\$) financial loss as a result of a power outage [15, 16].

ii) Restart Costs

Restart costs include damage assessment cost accrued (including hiring internal or external consultants or contractors); equipment, production material and consumables loss, damage, repair and replacement cost; wasted energy cost; and idle, restart and overtime labour cost to recover lost production. Each of these costs is discussed briefly in the following subsections.

Expert Damage Assessment

Occasionally, expert damage assessment is required through internal specialists or externally hired consultants or contractors.

Loss, Damage, Repair and Replace

This category includes costs due to loss, damage, repair, and replacement of manufacturing equipment, consumables or production material.

Restart Energy

This is the energy consumed by the complete plant, or part of the plant, from the moment of disruption until it is brought back to normal operation.

Idle and Restart Labour

Labour hire can be hourly, seasonal or annual, depending on the industrial sector, nature of the product and plant's labour hire practices. Seasonal and annual hire contracts usually take into account certain number of lost hours into account, which is either claimed back or left unclaimed. Either claimed or unclaimed, this is still an additional cost of downtime, which is not clearly observable. However, when the hire is hourly, or in scenarios when the plant needs additional labour paid at an hourly rate to restart or regain normal operation, the cost of this additional labour is clearly observable.

iii) Hidden costs

Hidden costs usually result from damage or losses that are not immediately or readily observed [13]. One method of quantifying this factor is through surveys conducted among plant personnel and customers, and comparing industry specific availability (“up-time”) scores among competitors.

Decreased Competitiveness, Reputation and Customer Dissatisfaction

High frequency of process disruption leads to poor product quality and reduced availability (usually quantified using Overall Equipment Effectiveness index, which is a product of equipment availability, performance and yield). In some cases, this can lead to delayed production schedules. These shortcomings certainly decrease competitiveness, reputation, customer satisfaction and customer loyalty, which can be very costly [13] and difficult to quantify.

Employee Annoyance as a Result of Process Disruption

Disturbance-related process disruptions occasionally cause dissatisfaction among the employees, especially if they lead to significant personnel involvement, cleaning and overtime work to recover lost production time. This factor is not readily quantifiable in terms of reduced efficiency.

iv) Other Factors

There are other factors that could influence the COD estimation. Since their impact on COD may be quite different for different end-users, they should be considered carefully and included only where applicable.

Hit Rate and Miss Rate

Typical definitions for ‘hit rate’ and ‘miss rate’ are not readily available in manufacturing literature. The following definitions were adopted based on correspondence with typical continuous manufacturing plant personnel. Hit rate is the ratio of intended use of resources and sum of intended and unintended (e.g. due to process disruption) use of resources. Miss rate is the ratio of unintended use of resources and sum of intended and unintended use of resources. Accordingly, miss rate is given as: $Miss\ rate = 1 - Hit\ rate$.

Pass Rate and Fail Rate

As in the previous case, typical definitions of ‘pass rate’ and ‘fail rate’ are not readily available in manufacturing literature. However, usage in various research publications (e.g. [17, 18]) suggests the following definitions of these terms. Pass rate is the ratio of product number or batches that passed a set quality criteria and total number of products or batches initiated. Fail rate is the ratio of product number/batches that did not pass the set criteria and total number of products or batches initiated. Accordingly, fail rate is given as: $Fail\ rate = 1 - Pass\ rate$.

Plant Voltage Disturbance Trend with Time

For a given work schedule, the process activity pattern changes with the time of the day. The work schedule pattern for each day may also vary with the day of the week.

Consequently, COD also varies depending on process failure occurrence with 'time scope' (time of the day, day of the week, month/season of the year, and even years).

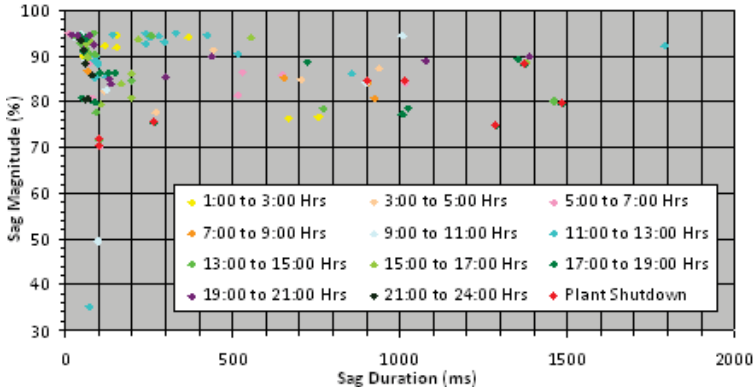

Figure 5-1 Voltage dip pattern with time of the day.

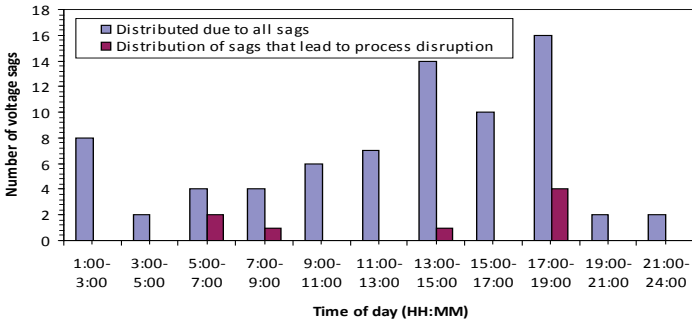

Figure 5-2 Hourly variation in number of voltage dips at the primary side of facility transformer.

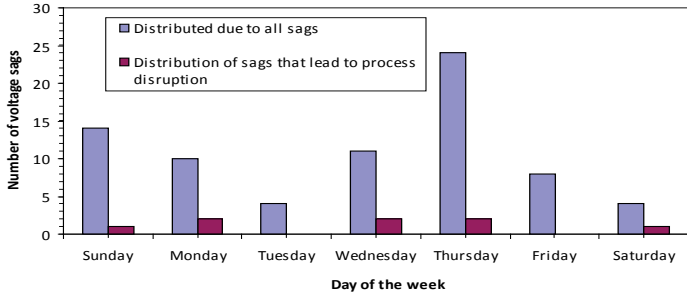

Figure 5-3 Daily variation in number of voltage dips at the primary side of facility transformer.

When COD and voltage dip profile (at the secondary side of supply transformer) trends in time are compared, appropriate decisions can be made by the facility manager/engineer to bring down COD by re-arranging the work schedules to less failure-prone time intervals and initiate investments to bring PQ improvement where such re-arrangement of work schedule is not flexible.

Figures 5-1 to 5-4 show hourly, daily, weekly and monthly voltage dip trends, derived from monitoring data at the primary side of supply transformer of an industrial facility over a period of three years. During this monitoring period, the plant experienced eight process disruptions. The distribution of experienced dips in time is also included in Figures 5-1 to 5-4. (Note: Voltage dip magnitude and duration used in these results are the lowest magnitude and the longest duration seen among three phases.)

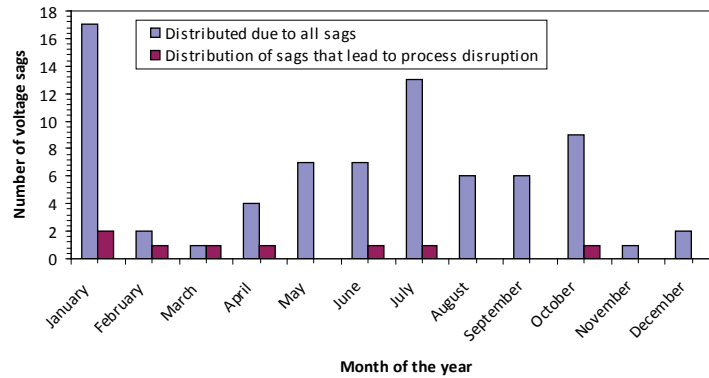

Figure 5-4 Monthly variation in number of voltage dips at the primary side of facility transformer.

Figure 5-1 shows voltage dip distribution pattern with various times of the day in voltage dip magnitude-duration plane. Voltage dips that lead to plant shut down are marked using a red diamond shape. From both Figure 5-1 and Figure 5-2, it can be concluded that most voltage dips and most process disruptions occur between 17:00-19:00hrs of the day. Figure 5-2 also shows that number of experienced dips increases gradually as the day progresses, and reaches its peak between 17:00-19:00hrs, and then falls down sharply.

Both, the trend of voltage dip number with day of the week (Figure 5-3) and yearly trend (Figure 5-4) have also two peaks (as daily variation), on Sunday and Thursday for weekly variation, and in January and July for yearly variation.

COD Dependence on Time, Power Consumption and Business Type

Although not directly related to the downtime caused by voltage dips, a review of customer outage costs in [17] presents the trends for COD depending on downtime duration and other influencing factors (e.g. time of day, business sector type, etc.) These trends, reproduced here in Figure 5-5, suggest that the COD in most cases increases substantially with the duration of downtime, and that the increase is non-linear.

The study in [17] also predicts that the average cost experienced by a “typical” end-user for a single summer afternoon outage of one hour is negligible for residential customer, reasonably low for small-medium commercial and industrial customer, and significant for large commercial and industrial customer. This emphasises high variability of the costs depending on the type of customer and type of processes involved. For an outage of a given duration or at a given time of day, outage costs are generally higher in the winter than in the summer. Comparison of various business sectors suggests that mining and construction sectors are the most affected. Also, and perhaps unsurprisingly, customers with higher annual electricity consumption are likely to be more affected.

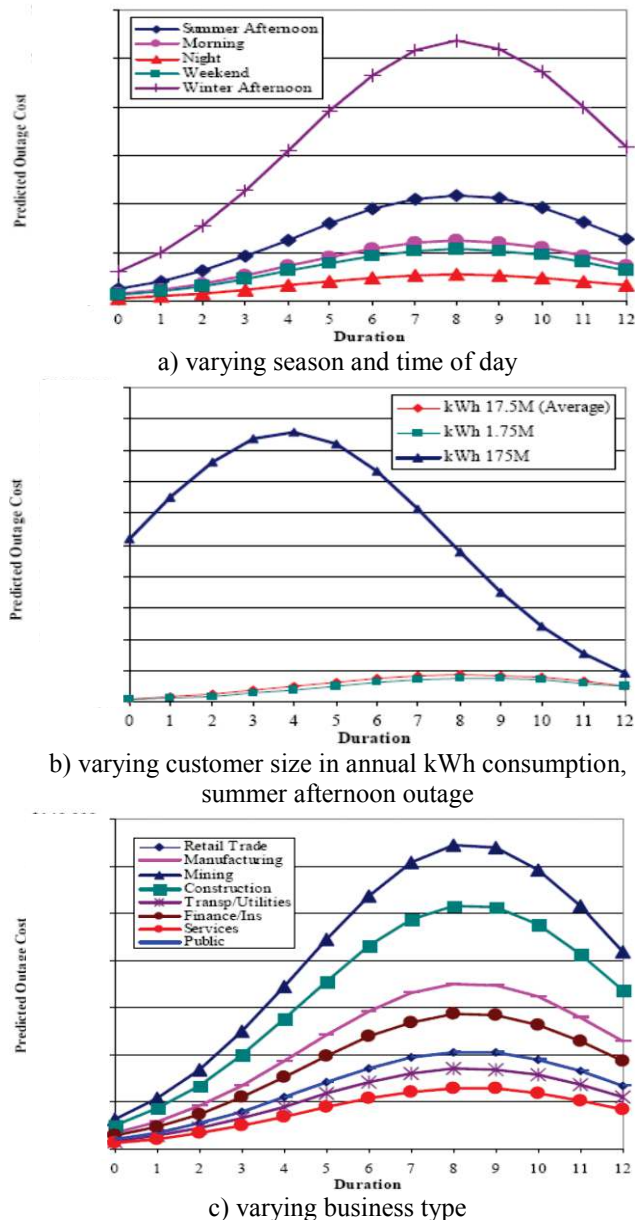

Figure 5-5 Customer COD models as a function of various attributes (adopted from [17]).

Although the data in Figure 5-5 are related to outages, they are included here to demonstrate the variability of COD with the actual time of disruption occurrence, i.e., time of day, week and season, and to emphasise the importance of logging (tracking) the “time of disruption occurrence” information.

5.5 Cost of increasing equipment immunity to voltage dips

The final component affecting optimal decision regarding investment in increased equipment immunity is the cost of increasing equipment immunity itself.

The costs of equipment dip immunity can be divided into recurring costs (for example, costs of increased capacitor size recur every time a power supply is made with the larger and more expensive dc link capacitor) and non-recurring costs (for

example, the engineering/design costs and testing costs for the increased capacitor occur only once).

In general, the recurring costs of equipment dip immunity are roughly proportional to the amount of (stored) energy required by the equipment to ride-through particular dip events. For this reason, it is generally far less expensive to provide dip immunity for Type I and Type II dips, than to provide dip immunity for Type III dips. (In the case of Type I and Type II dips, energy required by equipment to survive the dip is needed only for a fraction of a cycle, regardless of the dip duration; in the case of Type III dips, equipment requires a far larger amount of energy, for the entire dip duration, to survive the dip; see Chapter 2 for classification of dips into three general types.)

In considering voltage dip immunity requirements, therefore, the following economic costs should be analysed:

a. Increased equipment costs, comprising of cost of additional component(s) and construction costs, final product reliability costs, as well as space and size related costs due to the redesign of the final product

b. Increased engineering costs, comprising direct equipment engineering costs, training and knowledge costs, as well as (internal) testing and re-prototyping costs

c. Testing and certification costs, including test equipment costs (e.g. equipment-under-test with higher rated power/current is usually heavy and less mobile, what requires high-specification and portable test equipment) and third-party costs (external consultants involved in testing and certification)

Based on the experience from studies carried in the past [18], it could be concluded that:

- The typical cost of the solution hardware required to make the equipment comply with SEMI F47 requirements [19] was up to US\$2,000.
- Typical testing and certification cost was about US\$10,000, The solutions applied in the past involved either a power conditioner for sensitive equipment control circuits, or replacing sensitive control elements with units certified to meet the standard. In most contemporary equipment, dip immunity is achieved primarily through the adjustment of equipment control software and sensors that equipment use to detect voltage dips, i.e. the equipment “figures out” how to recover from the dip.

5.6 Selection of mitigating solutions for individual installations

A thorough evaluation of network dip performance (and corresponding financial impact) with and without any mitigating solution applied is necessary for deciding on the level of network investment in mitigating devices and/or solutions. This evaluation is ultimately an exercise in economics. Facility engineers must evaluate the economic impact of voltage dips on their plant against the costs of improving the performance by implementing network level modifications, installing mitigating devices, or increasing the immunity levels of the equipment.

A general procedure for making investment decisions on improving process resilience to voltage dips is diagrammatically shown in Figure 5-6. This is basically an optimisation process, which consists of several stages, briefly discussed below. Further details on the techno-economic assessment of voltage dip mitigating solutions are available in [20-22].

1. Estimate dip performance at equipment terminals through computer simulations (part of the diagram encircled by dashed line in Figure 5-6), or through analysis of available monitoring data. This estimation has to be performed with and without the solution that is to be applied, in order to establish the effectiveness of the solution in reducing impact of critical voltage dips.
2. Establish equipment or process immunity threshold/requirement based on process immunity time (PIT, see Chapter 3).
3. Estimate annual number of process disruptions with and without selected mitigating solution (from steps 1 and 2).
4. Calculate annual financial losses resulting from process failures and disruptions with and without considered solution.
5. Estimate the cost of solution taking into account all relevant associated costs, considering whether the solution is network level, process level or through improved equipment immunity.
6. Take into consideration other benefits and/or drawbacks resulting from application of a particular solution (e.g., additional benefits which are not directly reflected in improvement of process immunity to voltage dips)
7. Make investment decisions based on comparison of the financial implications resulting from steps 4, 5 and 6.

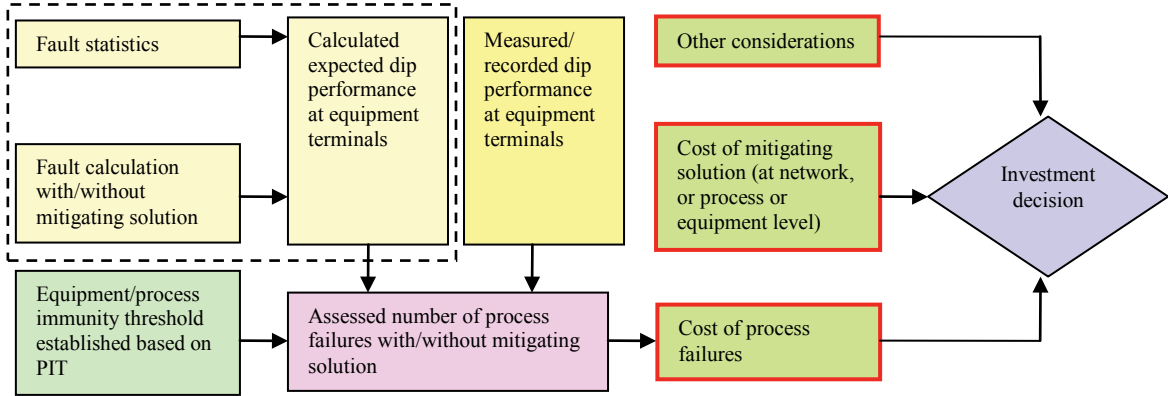

Figure 5-6 Investment analysis process.

5.7 Setting standards for voltage dip immunity levels

There is presently a relatively limited range of standards for equipment voltage dip immunity. Where they exist, standards for general voltage dip immunity levels (usually) should be considered separately from dip immunity requirements formulated for specific individual equipment. It should be also made clear that the immunity of key assessed items of plant will not necessarily result in a complete process

immunity to voltage dips.

5.7.1 Existing standards

Following standards for voltage dip immunity have been in use for more than a decade:

- IEC 61000-4-11 and IEC 61000-4-34, which give methods for testing equipment immunity to voltage dips and short interruptions. Standard 61000-4-11 applies to equipment rated at 16 A per phase or less, while standard 61000-4-34 applies to equipment with rated current greater than 16 A.
- SEMI F47-0706, which sets dip immunity requirements for equipment used in semiconductor processing factories. The requirements in this standard are very close to requirements in IEC 61000-4-34, and both standards use the same method for testing equipment dip immunity.

It should be noted that the IEC standards give mandatory dip immunity requirements for equipment used in all sectors, whereas SEMI standard applies only to the semiconductor industry. Although SEMI F47 is an advisory standard, almost all purchasers of new semiconductor equipment require that the equipment comply with this standard, so the standard is effectively mandatory in the semiconductor industry.

5.7.2 Economic trade-offs in standards for voltage dip immunity levels

Standards for general voltage dip immunity levels provide a sound basis for the general procurement of discrete plant items, but the specific requirements of the facility or process in which this plant is utilised has to be separately considered to ensure that the immunity requirements of the whole process/location are addressed.

For particular individual equipment and/or specific locations, the economic impact of dip immunity requirements can be accurately evaluated (although this may be complex), and appropriate economic trade-offs can be made. The costs of dip immunity are normally borne by the same organisation, or individual, receiving the benefits.

However, the economic impact of a general dip immunity standard – which usually should be applied to a broad range of equipment, some of which may not actually require any level of dip immunity – cannot be readily evaluated. For this reason, standard-writers should be careful and cautious about setting these general requirements.

In case of general dip immunity standards, the costs of (required or increased) dip immunity are diffused among all purchasers of equipment, regardless whether or not they need this level of immunity, while the benefits are diffused only among those end-users (both direct and indirect) that happen to need that level of voltage dip immunity. For this reason, the overall cost of equipment compliance with mandatory dip immunity required by a general dip immunity standard should generally be less than the economic benefit to society that this dip immunity delivers.

5.7.3 Choosing dip immunity levels for standardisation

Because standards are applied to a broad range of equipment, which is used for a broad range of purposes, the criteria for selecting adequate dip immunity levels is complicated. The following issues should be considered.

The economic costs of the (required or increased) dip immunity levels include increased equipment cost, engineering cost, as well as testing and certification cost (including test equipment cost).

Although the true economic benefits of the dip immunity levels are uncertain (they do exist, but they are difficult to measure), they are certainly related to the number of avoided equipment trips, which in turn is determined by the number of dips that exceed the dip immunity levels.

Consequently, standards should set and select such dip immunity requirements that: (a) include large numbers of dips, and (b) have relatively inexpensive or highly beneficial immunity requirements.

Note that the IEC and SEMI standards meet requirement (a) above by choosing depth-duration requirements that cover a large number of dips, and requirement (b) by limiting themselves to Type I and Type II dips. These standards implicitly recognise that immunity to Type III dips is far more costly, but they do not comment on possible beneficial effects of setting equipment immunity to Type III dips (see e.g. Chapter 5 for statistics on Type III dips).

To minimise the cost to society, standards should always set minimum dip immunity requirements. Of course, specific applications, equipment, or end-users may be justified in asking for higher immunity, if their corresponding economic trade-offs require it, but those requirements should not be developed into standards without a careful and more general evaluation.

5.8 Conclusions

This chapter addresses in some detail the main factors influencing decisions about the investment in increased immunity of equipment.

It started by specifying the data needed to set voltage dip immunity requirements and briefly discussing methodologies for the assessment of number and characteristics of voltage dips at equipment terminals. Factors influencing the assessment of cost of downtime of industrial processes are discussed next, followed by a more detailed elaboration of costs of increasing equipment immunity to voltage dips. The methodology for making sound economic decisions regarding the investment in dip mitigating solutions are also presented. Finally, the chapter summarised some general requirements for setting standards on voltage dip immunity levels.

When discussing the economics of voltage dip immunity, one must be aware that in some cases immunity is (or might be) economically impractical. Complete voltage dip immunity may be prohibitively expensive for some equipment. For example, unbalanced dips certainly occur, and they do affect the operation of a 2,000 horsepower synchronous motor. However, it may be economically impractical to correct these effects due to the scale of the required investment and the technical

challenge.

The costs also depend on the meaning of “immunity”, and how wide this immunity should be, i.e., immunity of the equipment or immunity of the process? For example, making a vegetable oil processing plant completely immune to voltage dips may be extremely expensive. Modifying critical equipment (or partial production processes) within the plant, so that they can automatically restart after a voltage dip, may be much cheaper.

This chapter emphasises the fact that the process of selecting appropriate immunity of the equipment (or industrial/commercial process) to voltage dips involves complex techno-economic optimisation, where setting of different parameters involved may require quite different expertise. Therefore, close collaboration between a range of specialists within an industrial facility is necessary for selecting an adequate or optimal level of equipment/process dip immunity.

5.9 References

- [1] CIGRE TF C4.1.02: “Voltage Dip Evaluation and Prediction Tools”
- [2] M. H. J. Bollen. “Understanding Power Quality Problems: Voltage Sags and Interruptions”. IEEE Press Series on Power Engineering, 2000.
- [3] M. R. Qader, M. H. J. Bollen and R. N. Allan, “Stochastic Prediction of Voltage Sags in a Large Transmission System”, IEEE Transactions on Industry Applications, Vol. 35, No. 1, pp. 152-162, January/February 1999.
- [4] G. Olguin and M. H. J. Bollen, “Stochastic Prediction of Voltage Sags: An Overview”, Probabilistic Methods Applied to Power Systems Conference 2002, September 22-26, Naples, Italy.
- [5] G. Olguin and M. H. J. Bollen, “Method of Fault Positions for Stochastic Prediction of Voltage Sags: A Case Study”, Probabilistic Methods Applied to Power Systems Conference 2002, September 22-26, Naples, Italy.
- [6] J. V. Milanovic, M. T. Aung and C. P. Gupta, “The influence of fault distribution on stochastic prediction of voltage sags”, *IEEE Transactions on Power Delivery*, Vol 20, No. 1, pp. 278-285, 2005.
- [7] M. T. Aung, J. V. Milanovic and C. P. Gupta, “Propagation of Asymmetrical Sags and the Influence of Boundary Crossing Lines on Voltage Sag Prediction”, *IEEE Transactions on Power Delivery*, Vol 19, No. 4, pp. 1819-1827, 2004.
- [8] M. T. Aung and J. V. Milanović, “The influence of transformer winding connections on the propagation of voltage sags”, *IEEE Transactions on Power Delivery*, Vol 21, No. 1, pp. 262-269, 2006.
- [9] M. T. Aung and J. V. Milanović, “Stochastic Prediction of Voltage Sags by Considering the Probability of the Failure of the Protection System”, *IEEE Transactions on Power Delivery*, Vol 21, No. 1, pp. 322-329, 2006.
- [10] R. Gnativ and J. V. Milanovic, “Qualitative and quantitative analysis of voltage sags in networks with significant penetration of embedded generation”, *European Transactions on Electrical Power Engineering*, Vol.15, pp. 77-93, 2005.
- [11] J. V. Milanovic and S. Z. Djokic, “Equipment sensitivity to disturbances in voltage supply”, International Electric Equipment Symposium on the Electric Network of the Future and Distributed generation JIEEC 2003, 28-29 October 2003, pp. 3.7/1-3.7/14, Bilbao, Spain.

- [12] S. C. Vegunta and J. V. Milanović, "Estimation Of Cost Of Downtime Of Industrial Process Due To Voltage Sags ", *CD Rom of CIRED 2009, 8-11 June 2009, Prague, Czech Republic, (paper 0842)*.
- [13] "Power Quality: Customer Financial Impact/Risk Assessment Tool," BC Hydro, A04 587b, 2005.
- [14] M. M. Izhwan, M. Norman, and M. A. M. Radzi, "The Effects of Power Quality to the Industries," 5th Student Conference on Research and Development, SCOReD, pp. 1-4, 2007.
- [15] M. F. Han and K. Yeon-hee, "Samsung Elec says outage loss not to top \$54 mln," in *Reuters*, 2007.
- [16] "Samsung Shares Lower on Concerns over Power Outage-Production Loss," in *AsiaPulse News*, 2007.
- [17] R. B. Chandler, M. J. Jellison, J. W. Skogsberg, and T. Moore, "NACE 02056 Advanced Drill String Metallurgy Provides Enabling Technology for Critical Sour Drilling," 2002.
- [18] I. Gyuk, L. Lawton, M. Sullivan, K. V. Liere, A. Katz, and J. Eto, "A Framework and Review of Customer Outage Costs: Integration and Analysis of Electric Utility Outage Cost Surveys," Ernest Orlando Lawrence Berkeley National Laboratory, Berkeley, CA LBNL-54365, 2003.
- [19] Semiconductor Equipment and Materials International (SEMI), Specification for semiconductor processing equipment voltage sag immunity SEMI Standard F47-07, 2006.
- [20] J. V. Milanović and Y. Zhang, "Gobal minimisation of financial losses due to voltage sags with FACTS based devices", *IEEE Transactions on Power Delivery, TPWRD-00518-2007*.
- [21] Y. Zhang and J. V. Milanović, "Techno-economic improvement of voltage sag performance with facts devices", *CD Rom of the 9th International conference on electrical Power Quality and utilization, EPQU'07*, Barcelona, Spain, October 9-11, 2007.
- [22] J. V. Milanović and Y. Zhang, "Voltage sag reduction with optimally placed FACTS devices", *CD Rom of the 9th International conference on electrical Power Quality and utilization, EPQU'07*, Barcelona, Spain, October 9-11, 2007.

6 Statistics

6.1 Data collection

In order to understand voltage dips and the scale and potential impact of dip occurrences, the data recovered by power utilities from power quality monitors around the world is vital. Decisions and proposals to manage the consequences of voltage dips require to be based on real data, not only on common assumptions. However, although broad country and continent specific studies have been undertaken in the past, power quality (specifically dips) has rarely been analyzed on a such a large scale.. Due to the very large volumes of data (and analysis) required to understand these data sets, recovered from almost 1200 sites, an automatic and structured methodology was devised for this report.

6.1.1 Scope of the survey

Most of the PQ monitor data comes from network operators, since they are by far the most active parties regarding power quality management and surveys. Some of the surveys have been temporal while others are still in place and continue providing data over the longer term. Nevertheless, the smaller surveys of shorter than four weeks have been disregarded. Table 6-1 below illustrates the breadth and depth of the data managed and analysed in this Chapter. Multiple rows for the same country refer to different surveys within one company or data obtained from different companies within the same country. The sources are not identified here on request of some of the companies that provided data.

Country	Source	Voltage level	Minimum monitoring voltage [kV]	Maximum monitoring voltage [kV]	Phase-to-phase [p2p] or phase-to-neutral [p2n] measurement	Minimum monitoring period	Maximum monitoring period	Number of sites
CANADA		LV	0.120	0.120	p2n	607 days	730 days	2
CANADA		HV	120	230	p2p & p2n	151 days	181 days	2
CANADA		MV	25	25	p2p & p2n	151 days	516 days	7
PORTUGAL		HV	60	60	p2p	30 days	303 days	14
PORTUGAL		LV	0.4	0.4	p2n	29 days	123 days	159
PORTUGAL		MV	15	30	p2p	29 days	365 days	62
UK		MV	16	16	p2n	28 days	2222 days	84
UK		MV	16	16	p2p	28 days	2222 days	189
SOUTH AFRICA		HV	44	132	p2p	31 days	2557 days	29
SOUTH AFRICA		HV	44	132	p2n	1369 days	2557 days	205
USA		MV	13.6	13.6	p2p	4475 days	4475 days	1
USA		HV	110	110	p2n	30 days	306 days	16
AUSTRALIA		LV	0.415	0.415	p2p	28 days	28 days	1
AUSTRALIA		MV	6.6	33	p2p	28 days	59 days	29
AUSTRALIA		LV	0.24	0.24	p2n	28 days	89 days	25
AUSTRALIA		LV	0.24	0.24	p2n	701 days	701 days	1
SPAIN		MV	6	28	p2p	88 days	1656 days	290
SPAIN		HV	50	220	p2p	60 days	1494 days	41
SPAIN		LV	0.4	0.4	p2n	80 days	1138 days	18
								1175

Table 6-1 Monitored sites by country, company and voltage level.

6.1.2 Phase-to-phase or phase-to-neutral controversy

The focus of this report has been the study of the effects of voltage dips on connected equipment in installations i.e. the impact of dips on real processes. When considering LV connected equipment, since it is most common to have a neutral conductor, phase-to-neutral measurements have been used. For MV voltages and above, power quality data was also available, but its effect on real equipment connected at LV has been inferred. Since most MV and HV customers are supplied via transformers with only three input

conductors (phases) on the primary side, relative potentials to ground are not transferred across the transformer. These assumptions are explained in more detail in Chapter 2. Obviously there will be certain cases where the inferred or calculated approach may be imperfect, but in fact this is better than using available phase-to-ground records at MV or HV and above where it is recorded. Even in Canada, where some MV networks do have a neutral, the studied industrial sites had Dy transformers, thus converting phase-to-phase primary voltages on phase-to-neutral secondary voltages.

6.1.3 Data applicability

As stated the objective of this report is the analysis of the effect of voltage dips on connected equipment in installations. Consequently, it will be understood that this primarily means LV connected equipment. Preferably, therefore the data considered should be derived from LV monitors and data loggers. However since the utility based LV surveys were mostly undertaken at MV/LV substations in public distribution networks, they have a strong bias towards residential customers. On the other hand, the MV and HV data are more representative of the connections and experience associated with industrial and commercial customers and, the most importantly, correspond to a larger proportion of the sites monitored since they are the common points of measurements for distribution and transmission network operators. Consequently, this MV and HV data has been adapted to the profile it would have at LV.

6.1.4 Data limitations

The analysed data from the collected monitoring database is quite diverse and the following general characteristics were observed.

- Most submitted data do not contain the sampled event waveforms.
- Most record minimum RMS voltage and duration.
- Some only record the lowest measured voltage during the dip, not the other two phases.
- Many records are from monitors configured for phase-to-ground at MV and above.

Therefore, some approximations and transformations had to be made to ensure that common characteristics were extracted for use in the statistics. Some records were unsuitable for certain types of analysis and were excluded where this was the case.

6.2 Main features of each data source

The six main sources of voltage dip records are described below by company/country with their main features and limitations. Where the $p2n2p$ ¹ conversion referred to in the text is explained in Section 6.3.1.

6.2.1 SPAIN – UTILITY - ENDESA

- Dy, Yd or Yy HV/MV transformers.

¹ By using three phase-to-neutral rms voltages, the phase-to-phase rms voltages can be estimated “ $p2n2p$ ” is used here as an acronym for this transformation.

- MV grounding through resistor (standalone or +zigzag): 300 A overhead, 1000 A underground.
 - HV not grounded.
- Yy EHV/HV and HV/HV transformers.
 - Solidly grounded at both sides.
- Dy MV/LV distribution transformers, solidly grounded, TT system.
- Phase-to-phase (HV, MV, substation level) and phase-to-neutral (LV, distribution transformer level):
 - $p2n2p$ conversion not needed.

6.2.2 PORTUGAL – UTILITY - EDP

- YNyn and YNd HV/MV transformers.
 - MV grounding through resistor or reactance (standalone or +zigzag, 300 A), or isolated.
 - HV solidly grounded.
- Dy MV/LV transformers (TT system).
- Phase-to-phase (HV, MV, substation level) and phase-to-neutral (LV, distribution transformer level):
 - $p2n2p$ conversion not needed.

6.2.3 SOUTH AFRICA – UTILITY - ESKOM

- Only HV measurements
- Phase-to-phase and phase-to-ground/neutral measurements, thus $p2n2p$ conversion required
- “Shallow” dips not available.

6.2.4 UK – UTILITY - Scottish Power

- Phase-to-phase and phase-to-ground/neutral measurements.
- Only worst channel supplied for each dip. Therefore, no $p2n2p$ conversion can be accomplished for phase-to-ground measurements.

6.2.5 CANADA – UTILITY - Hydro-Québec

- LV measurements at customer site: phase-to-neutral.
- Dy HV/MV transformers: secondary side solidly grounded.
- MV and HV measurements at customer’s PCC: phase-to-phase data (calculated by means of phase-to-ground waveforms).

6.2.6 USA – COMPANY - IBM

- The IBM Burlington Vermont site is supplied by two 115kV Transmission lines. The voltage is transformed to 13.6kV 20MVA Delta-Wye transformers (2 units).
- The disturbance data is recorded on the 13.6 kV system located at the switchgear.
- 10 ohm resistor connected in series on the Neutral Bushing of each transformer to limit the phase-to-ground fault current.

6.3 Algorithms

In this section the calculation methods employed throughout the text are defined so that the relevant calculations can be repeated in the future with additional or new data. Basically there are three algorithms used through all the analysis:

- At MV and above, the conversion of RMS phase-to-ground voltages into RMS phase-to-phase voltages.
- Dip classification according to I, II and III classes.
- Matching of the dips to the IEC 61000-4-11 and 61000-4-34 standard test vectors. (hereafter referred to as “IEC standard test vectors”).

6.3.1 Conversion of RMS phase-to-ground voltages into RMS phase-to-phase voltages [p2n2p]

The method is clearly explained in [1]. Many power quality surveys have been done at MV or HV but measuring only phase-to-earth. The main goal here is to approximate the complex phase-to-earth vectors during the dip and thus to calculate the phase-to-phase voltages. These results will then be used for the statistical analysis.

This method does not apply for LV. It cannot be applied when only one of the three phases is recorded (therefore a substantial volume of data from sites at MV and HV must be disregarded).

A simple implementation of this algorithm implemented in Python (object oriented programming language) is shown in Table 6-2 below.

```
# Input voltages are va, vb and vc.

import sys
from math import pi, cos, sin, asin, exp

j = (0+1j)
SQRT3 = 3**0.5

def type2phasors( V, type, dv_or_phi ):

    type = type.upper()

    if type == 'A':
        Va = V
        Vb = -0.5*V - j*0.5*V*SQRT3
        Vc = -0.5*V + 0.5*j*V*SQRT3
    elif type == 'B':
        dv = dv_or_phi
        Va = V
        Vb = -0.5-0.5*j*SQRT3+dv
        Vc = -0.5+0.5*j*SQRT3+dv
    elif type == 'C':
        phi = dv_or_phi
        Va = 1
        Vb = -0.5-0.5*j*V*SQRT3*( cos(phi) + j*sin(phi) )
        Vc = -0.5+0.5*j*V*SQRT3*( cos(phi) + j*sin(phi) )
    elif type == 'D':
        phi = dv_or_phi
        Va = V
        Vb = -0.5*V*( cos(phi) + j*sin(phi) ) - 0.5*j*SQRT3
        Vc = -0.5*V*( cos(phi) + j*sin(phi) ) + 0.5*j*SQRT3
    elif type == 'E':
        Va = 1
```

```

    Vb = -0.5*V-0.5*j*V*SQRT3
    Vc = -0.5*V+0.5*j*V*SQRT3
elif type == 'F':
    Va = V
    Vb = -0.5*V -(2.0/3.0+1.0/3.0*V)*0.5*j*SQRT3
    Vc = -0.5*V+(2.0/3.0+1.0/3.0*V)*0.5*j*SQRT3
elif type == 'G':
    Va = 2.0/3.0+1.0/3.0*V
    Vb = -0.5*(2.0/3.0+1.0/3.0*V)-0.5*j*V*SQRT3
    Vc = -0.5*(2.0/3.0+1.0/3.0*V)+0.5*j*V*SQRT3

return (Va, Vb, Vc)

```

```
def dips2type( va, vb, vc ):
```

```

    vxyz = [va, vb, vc]
    vxyz.sort()
    (vx, vy, vz) = vxyz

    if (vz-vy) < (vy-vx):      # I & II

        vyz = (vy+vz)/2.0

        vyz_B = 1.0
        vyz_D = (3.0/4.0+1.0/4.0*vx**2)**0.5
        vyz_F = (1.0/3.0+1.0/3.0*vx+1.0/3.0*vx**2)**0.5
        vyz_A = vx

        if vyz < (vyz_A+vyz_F)/2.0:
            type = 'A'
            v = (vx+vy+vz)/3.0
        elif vyz < (vyz_F+vyz_D)/2.0:
            type = 'F'
            v = vx
        elif vyz < (vyz_D+vyz_B)/2.0:
            type = 'D'
            v = vx
            phi = asin( (vz**2-vy**2) / (v*SQRT3) )
        else:
            type = 'B'
            v = vx
            dv = (1-(1-4*(1-vyz**2))**0.5) / (2*(1-vx))

    else: # II & III

        vxy = (vx+vy)/2.0

        vz_A = vxy
        vz_G = (3.0-9.0*vxy+7.0*vxy**2)**0.5
        vz_C = 1.0

        if vxy < 1.0/3.0:
            if vz < 0.6:
                type = 'A'
                v = (vx+vy+vz)/3.0
            else:
                type = 'E'
                v = vxy
        else:
            if vz < (vz_A+vz_G)/2.0:
                type = 'A'
                v = (vx+vy+vz)/3.0
            elif vz < (vz_G+vz_C)/2.0:
                type = 'G'
                v = (2.0/3.0*vx**2+2.0/3.0*vy**2-1.0/3.0*vz**2)**0.5
            else:
                if vxy < 0.5:
                    type = 'E'
                    v = vxy
                else:
                    type = 'C'
                    v = (2.0/3.0*(vy**2+vx**2)-1.0/3.0)**0.5
                    phi = asin( (vy**2-vx**2) / (v*SQRT3) )

```

```

if type == 'B':
    ret = (type, v, dv)
elif type == 'C' or type == 'D':
    ret = (type, v, phi)
else:
    ret = (type, v, None)

return ret

(type, v, dv) = dips2type( va, vb, vc )
(Va, Vb, Vc) = type2phasors( v, type, dv )

Vab = Vb - Va
Vbc = Vc - Vb
Vca = Va - Vc

vp2p_pu = ( abs(Vab)/SQRT3, abs(Vbc)/SQRT3, abs(Vca)/SQRT3 )

print min( vp2p_pu )

```

Table 6-2 Python implementation for the p2n2p transformation.

6.3.2 Dip classification according to Type I, II and III

This phase type classification is covered in Chapter 2 annex 2B.

6.3.3 Comparison with IEC standard test vectors [2]

IEC 61000-4-11 Section 3 and IEC 61000-4-34 define several types of voltage dip test vectors. A simple algorithm based on phase-to-phase RMS voltages will be explained here in order to check whether these models are close to those considered realistic in the IEC documentation.

Three main test vectors are defined in IEC standards 61000-4-11 and IEC 61000-4-34. These are named 3A, 3B and 3C here and are as depicted in Figure 6-1.



Figure 6-1 Testing vectors 3A, 3B and 3C according to IEC 61000-4-34.

It is obvious that the phase-to-phase voltages must form a triangle. By using this simple fact and normalizing by the highest voltage, for each of the above types the resulting phase-to-phase voltages are shown in Table 6-3.



3A			$(1, 1, 1) \rightarrow (1, a, a)$
3B			$(1, 1, 1) \rightarrow (1, a, \sqrt{a^2 - a + 1})$
3C			$(1, 1, 1) \rightarrow \left(\frac{1}{2}\sqrt{3+a^2}, \frac{1}{2}\sqrt{3+a^2}, a \right)$ <u>normalization</u> <u>normalization</u> $\left(1, 1, \frac{2a}{\sqrt{3+a^2}} \right)$

Table 6-3 Test vectors and normalized expressions.

For each analysed dip, characterised by three phase-to-phase voltages, the algorithm takes these voltages as inputs and runs the three above approximations. The lowest error occurs for the set of vectors that provide the best fit to the IEC test vectors. A maximum error limit is allowed for the calculation, for instance 0.05 p.u.

An example of the above algorithm written in Python is shown in Table 6-4.

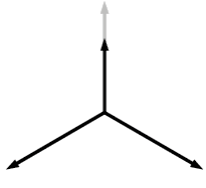
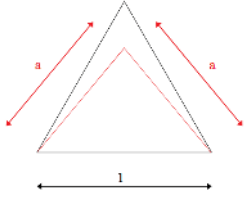
```

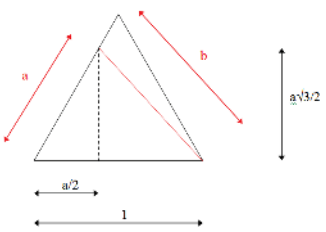
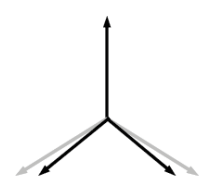
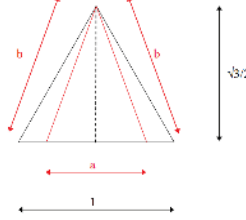
# Input voltages are va, vb and vc.
v = [va, vb, vc]

# Maximum allowed error (p.u.)
MAX = 0.05

# Normalization by the highest voltage.
v.sort()
v[0] /= v[2]
v[1] /= v[2]
v[2] /= v[2]

# Checking against 3B type.
a = v[0]
b = (a**2-a+1)**0.5
err_3b = abs( v[1] - b )

```

```

a = v[1]
b = (a**2-a+1)**0.5
err_3b = min( err_3b, abs(v[0]-b) )

# Checking against 3C type.
a = v[0]
b = 1
err_3c = max( abs(v[1]-b), abs(v[2]-b) )

# Checking against 3A type.
a = v[0]
b = a
err_3a = abs( v[1] - b )
a = v[1]
b = a
err_3a = min( err_3a, abs(v[0]-b) )

# Last check: chooses the lowest error and accept the model if bellow a certain value (MAX) .
err_best = min(err_3a, err_3b, err_3c)
if err_best > MAX:
    print 'NONE'
elif err_3a == err_best:
    print '(3A)'
elif err_3b == err_best:
    print '(3B)'
else:
    print '(3C)'

```

Table 6-4 Python implementation of IEC test vectors suitability.

This program code is only run for those dips classified as type-I or II according to the previous section (IEC test vectors do not apply for type-III dips).

6.4 Statistics and Charts

This section develops useful charts in support of other sections of the report. Assumptions and approximations taken will be based on real data, rather than intuition or best guesses.

It was considered that the contour charts for the graphical representation of electric supply dip characteristics, recommended by IEEE Std. 493 [3] formed a suitable platform to illustrate the analysis undertaken here. In order to present dip characteristics for several sites in the same chart, the percentile approach has been followed.

The Percentile, or Cumulative Probability, describes the probability distribution of a random variable. This method is often used in statistical representation of results from PQ monitoring, since many regulatory regimes allow some overshoot of a defined PQ threshold (e.g. EN 50160 excludes 5% of worst measurement values for compliance calculation). All measured values are sorted in ascending order. The so

called **Percentile 95%**, (CP95), is the value not exceeded by 95% of the measurement values. This means that 5% of the values are higher (more severe) than the CP95 value.

For better understanding, the Percentile methodology will be explained through a real example, the contour chart calculated for a percentile 75% (CP75) of dips from LV sites. All dips are characterized by the minimum voltage of all three phases and its duration. Building a number of dips per year table is the first step to create a contour chart. The number of rows and columns can be adjusted according to the resolution desired. The table used for contour charts in this report has 90 rows (voltage resolution is 1%) and 20 columns (for time). Each cell contains a value that represents the number of dips at the site which corresponds to percentile 75% (CP75) of the sites. The second step is derived from the values in the first table to create a second table presenting the total number of dips worse than or equal to the magnitude and duration headings used in the first table. The final step converts these values into a set of contour lines that form a CP75 contour chart. Further details on contour charts are provided in Annex 2 and in [5].

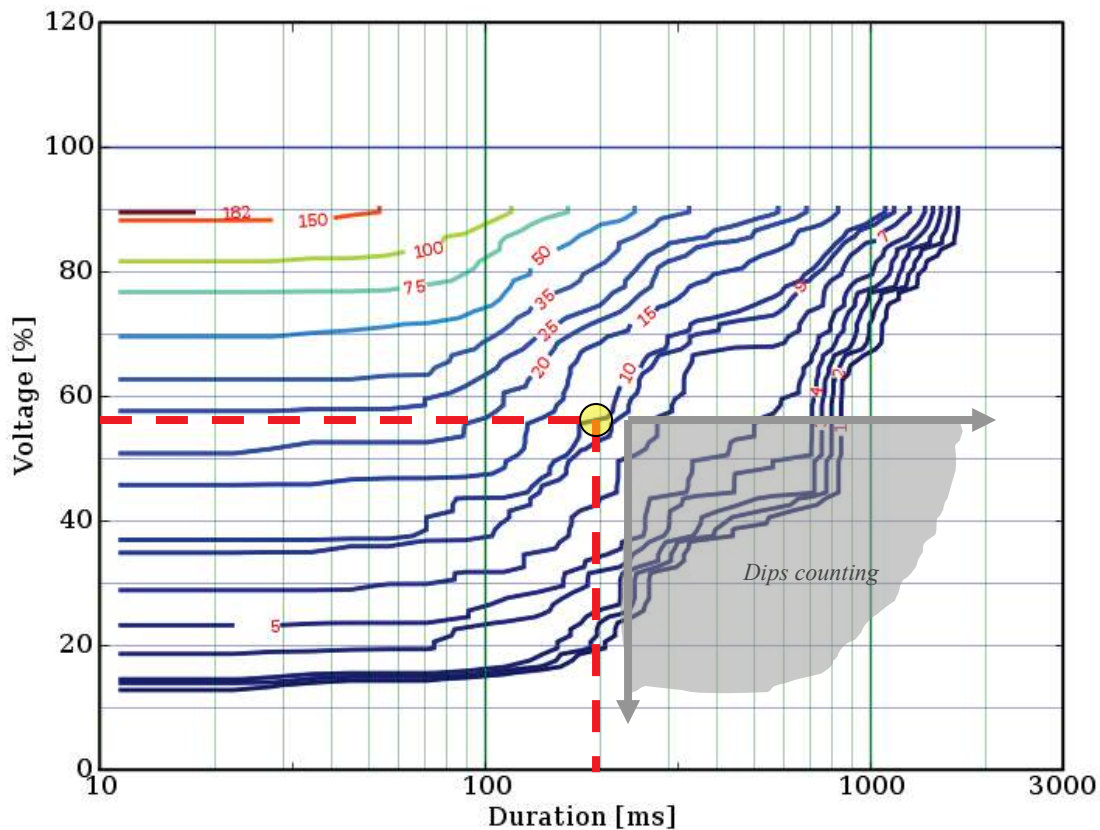

Figure 6-2 Example of a contour chart.

An example of a contour chart is shown in Figure 6-2. The curves in the figure, from lower left to upper right, have labels which represent number of dip events per year.

The *voltage-duration* point (yellow dot) from curve #10 has an associated value (around 10) which represents the number of dips per year and per site, more severe than the corresponding voltage-duration characteristics not exceeded by 75% of the sites. The resulting chart can also be explained as the number of dips not exceeded in all the studied sites except for the 100-75=25% worst sites.

Calculation can be undertaken for any percentile. This document includes only percentile 25% (CP25), 50% (CP50), 75% (CP75), 90% (CP90) and 95% (CP95). While the graphical representation is limited to 3 seconds, dips and interruptions up to 3 minutes are taken into account.

Charts can also be customised for many other parameters. In short, specific charts may be obtained by changing or stretching:

- Voltage level, i.e. 0-1 kV for LV, 1-36 kV for MV and 36- for HV.
- Country or Company.
- Whether or not the dips are counted by phase.
- Whether phase-to-ground/neutral voltages are converted into phase-to-phase voltages.
- Percentile (25%, 50%, 75%, 90%, 95%, etc.).
- Type of dip (I, II or III).
- Match to IEC 61000-4-34 standard, giving the following extended types I-3A, I-3B, I-3C, II-3A, II-3B, II-3C and III.

The following subsections give some examples of these charts. Needless to say as more sites and records are added to the database, the analysis and statistics will become increasingly representative.

6.5 Medium and high voltage sites

These charts will be the basic tool for Chapter 8 (*Dip immunity objectives*). Although, and as already stated in Section 6.1.3, the raw data is not derived directly from the LV system it is considered that it represents more accurately the real consequences of voltage dips on industrial equipment. However for completeness, Section 6.6 performs a similar analysis on raw LV data, even though it will not be used in subsequent chapters.

Only sites with three recording channels operating during a dip have been taken into account. Thus, those dips with basic type I, II, III dip characterisation and a match to the IEC test vectors (3A, 3B and 3C) are considered. The scope of the survey is named as “MANY” throughout the text, even for LV sites in subsequent sections.

In the following section the aforementioned charts are selected for 95%, 90%, 75%, 50% and 25% of the best sites. Please note that some charts have no contour lines at all, which means that for any voltage-duration pair the number of dips are below one.

6.5.1 Contour charts for the HV/MV 95% best sites, “MANY” scope

The contour charts for the 95% site over the HV/MV sites are shown in Figure 6-3 through 6-12. The specific data used for each chart is referred to in the caption with the figure. For each voltage-duration point the worst 5% of the sites are disregarded.

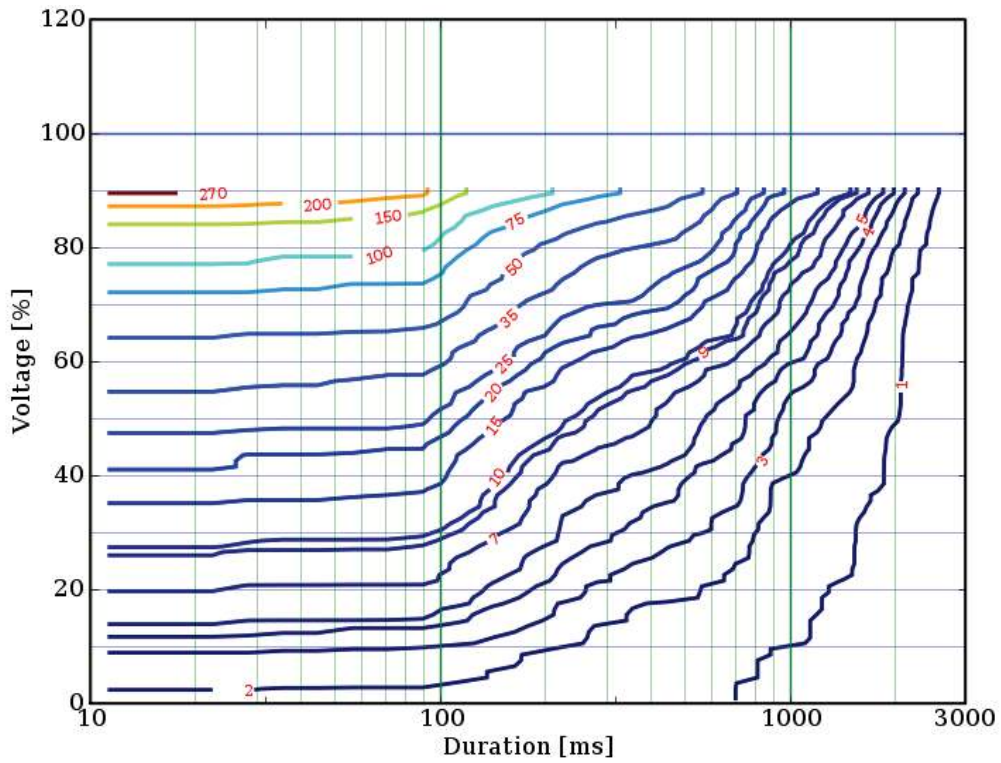

Figure 6-3 MV and HV sites, "MANY" scope (3 voltage channels recorded), 95% best sites.

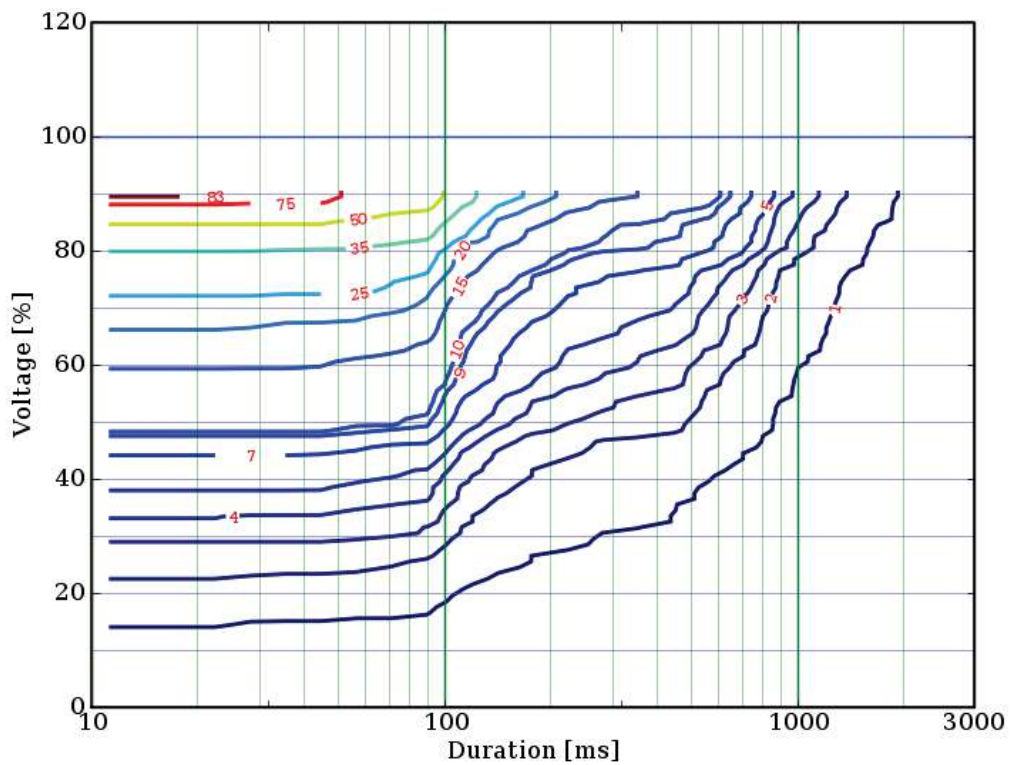

Figure 6-4 MV and HV sites, "MANY" scope (3 voltage channels recorded), only type I dips, 95% best sites.

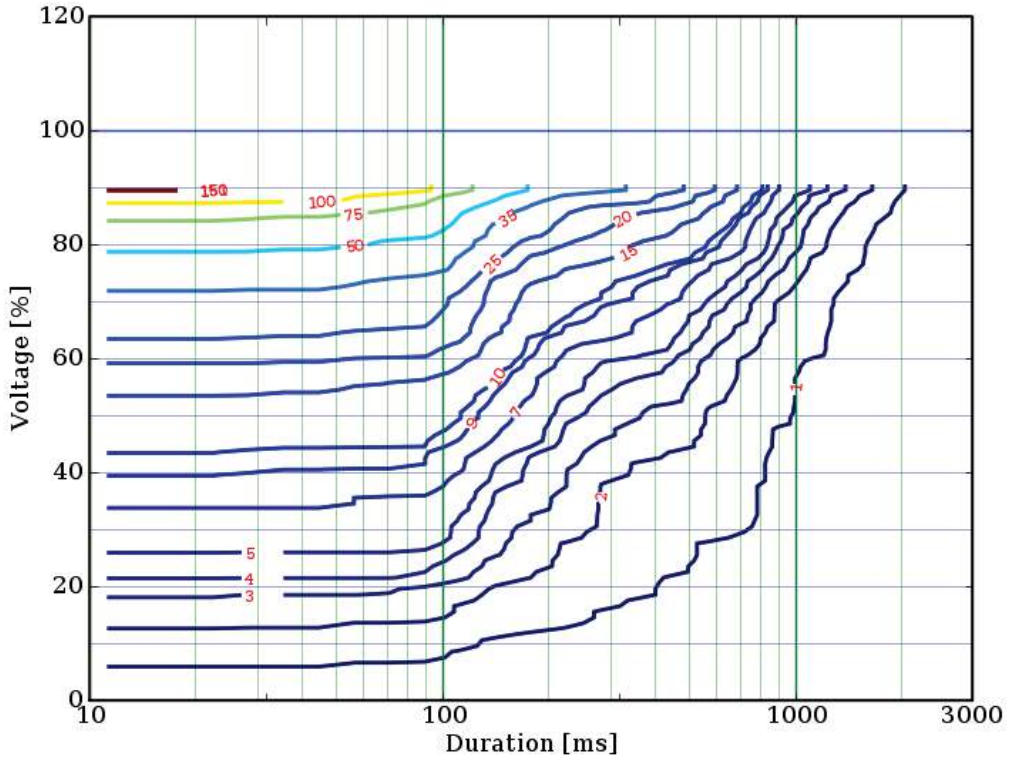

Figure 6-5 MV and HV sites, "MANY" scope (3 voltage channels recorded), only type II dips, 95% best sites.

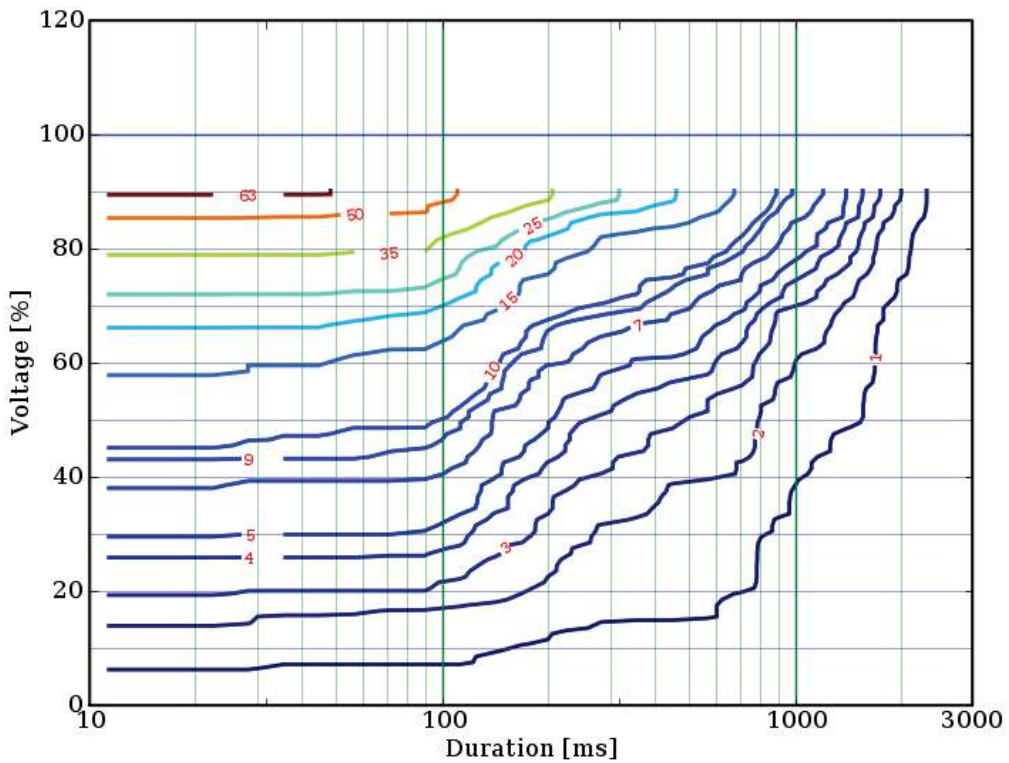

Figure 6-6 MV and HV sites, "MANY" scope (3 voltage channels recorded), only type III dips, 95% best sites.

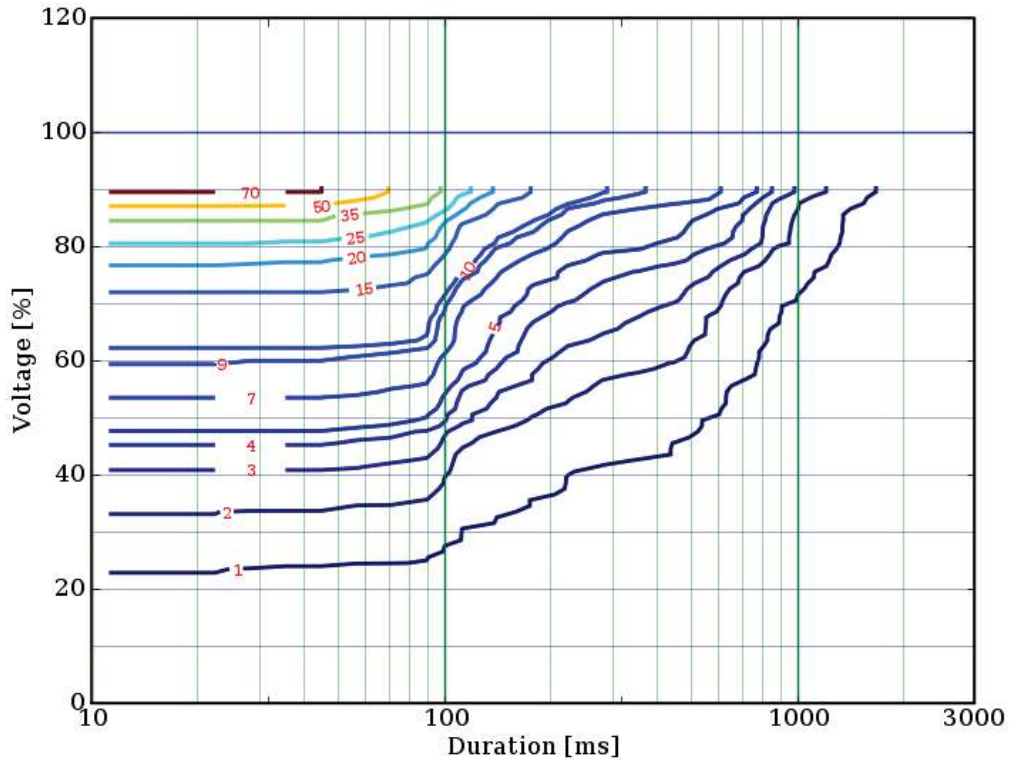

Figure 6-7 MV and HV sites, "MANY" scope (3 voltage channels recorded), type I and (3A) shape at the same time, 95% best sites.

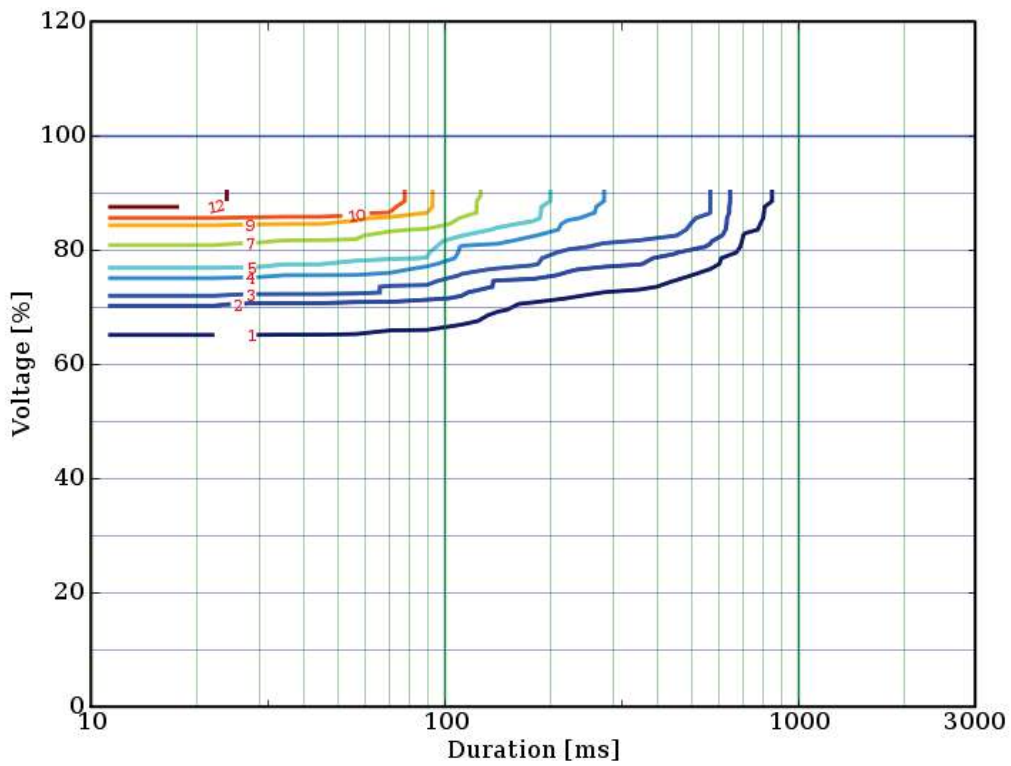

Figure 6-8 MV and HV sites, "MANY" scope (3 voltage channels recorded), type I and (3B) shape at the same time, 95% best sites.

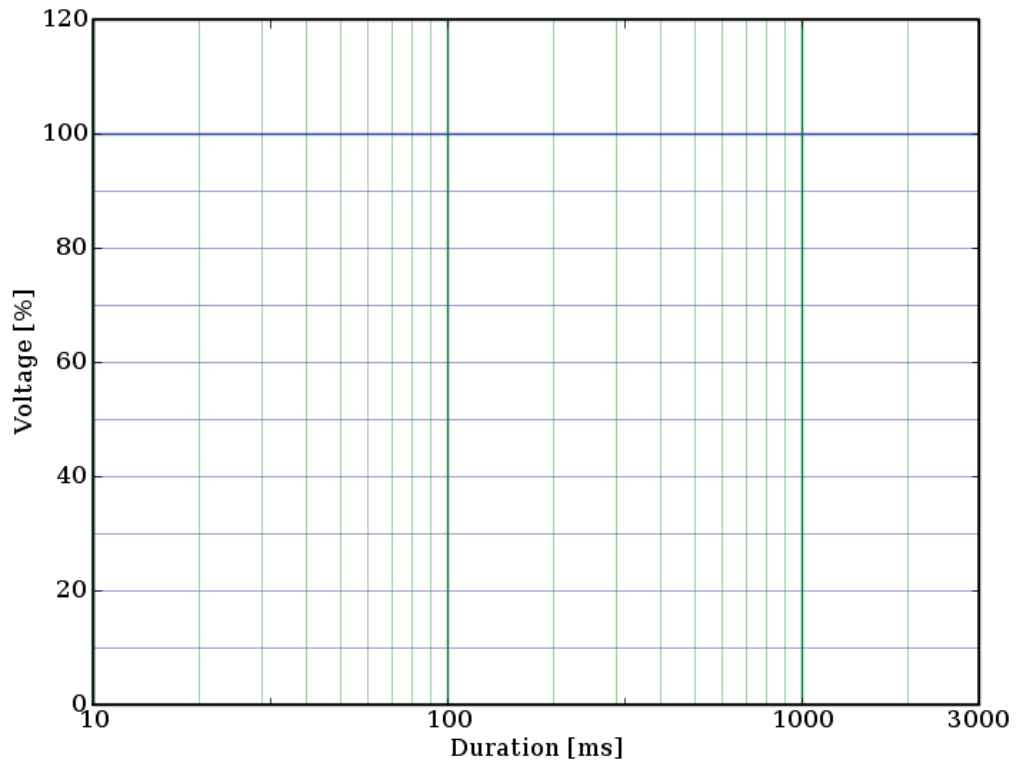

Figure 6-9 MV and HV sites, "MANY" scope (3 voltage channels recorded), type I and (3C) shape at the same time, 95% best sites.

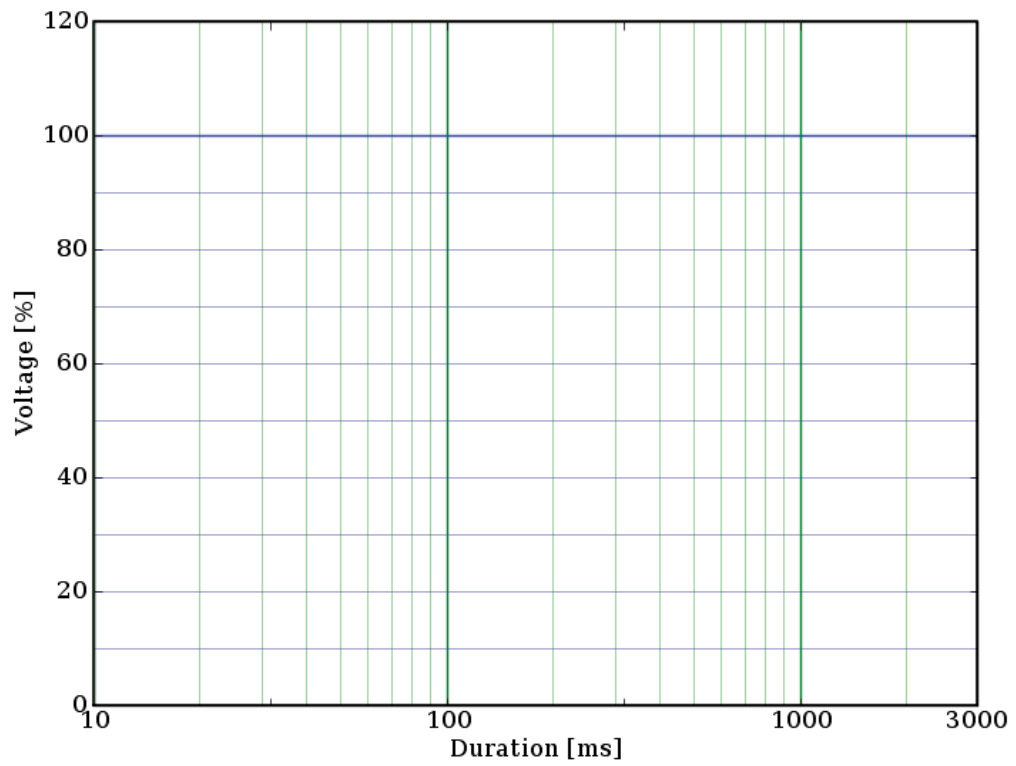

Figure 6-10 MV and HV sites, "MANY" scope (3 voltage channels recorded), type II and (3A) shape at the same time, 95% best sites.

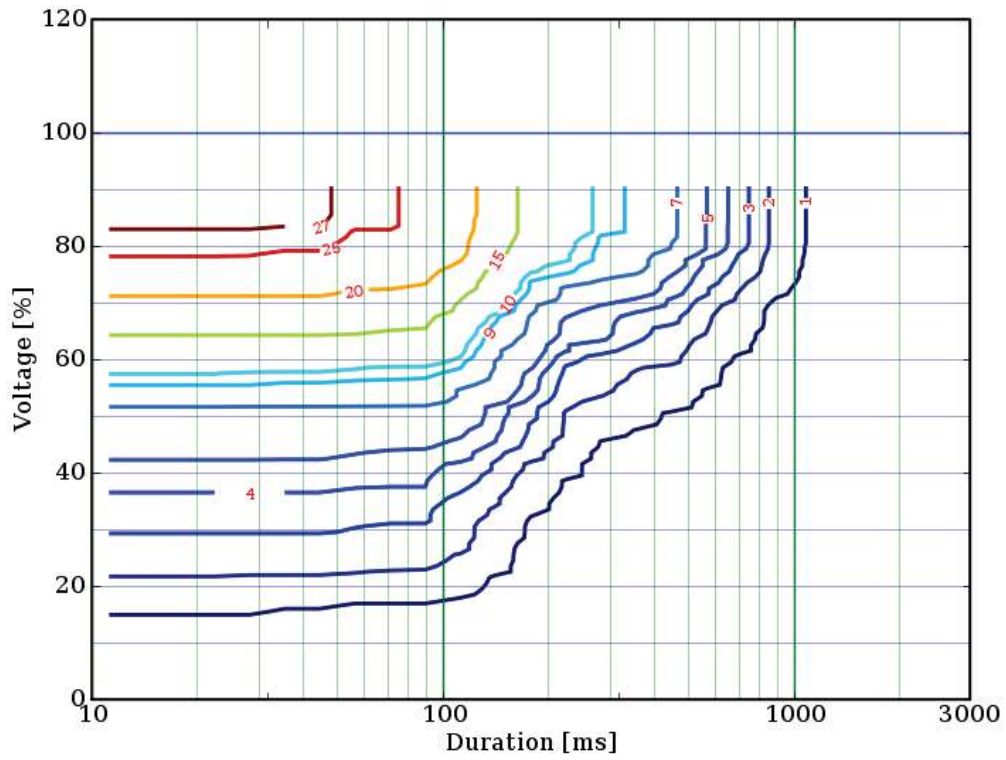

Figure 6-11 MV and HV sites, "MANY" scope (3 voltage channels recorded), type II and (3B) shape at the same time, 95% best sites.

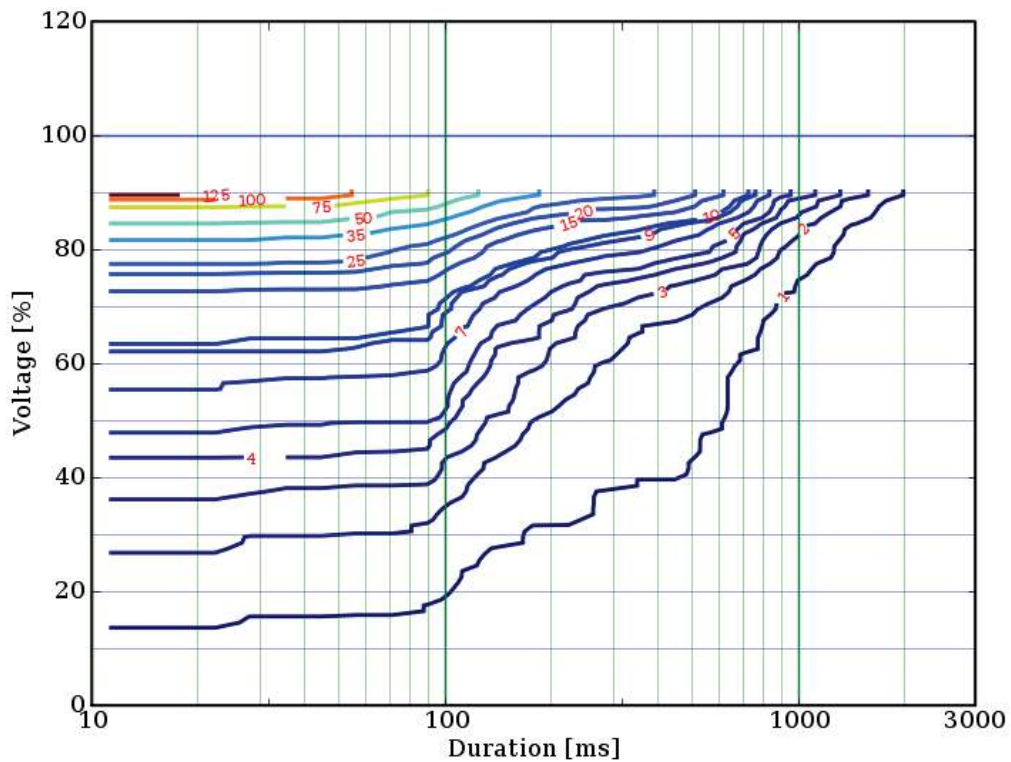

Figure 6-12 MV and HV sites, "MANY" scope (3 voltage channels recorded), type II and (3C) shape at the same time, 95% best sites.

6.5.2 Contour charts for the HV/MV 90% best sites, "MANY" scope

The contour charts for the 90% site over the HV/MV sites are shown in Figure 6-13 through 6-22. For each voltage-duration point the worst 10% of the sites are disregarded.

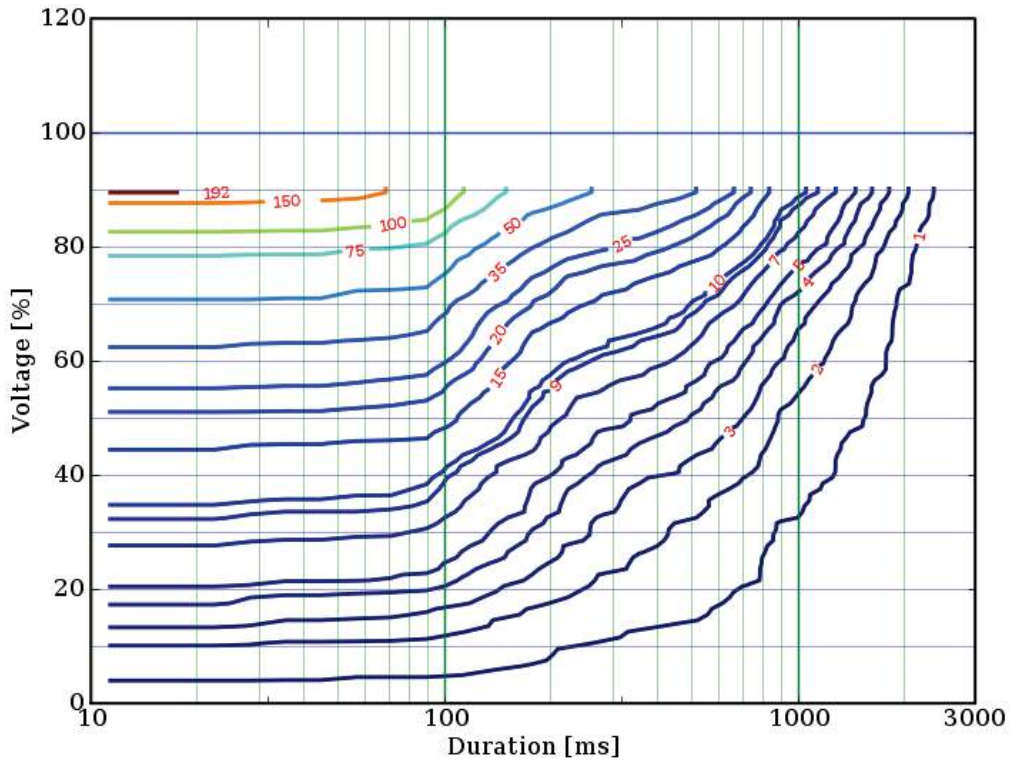

Figure 6-13 MV and HV sites, "MANY" scope (3 voltage channels recorded), 90% best sites.

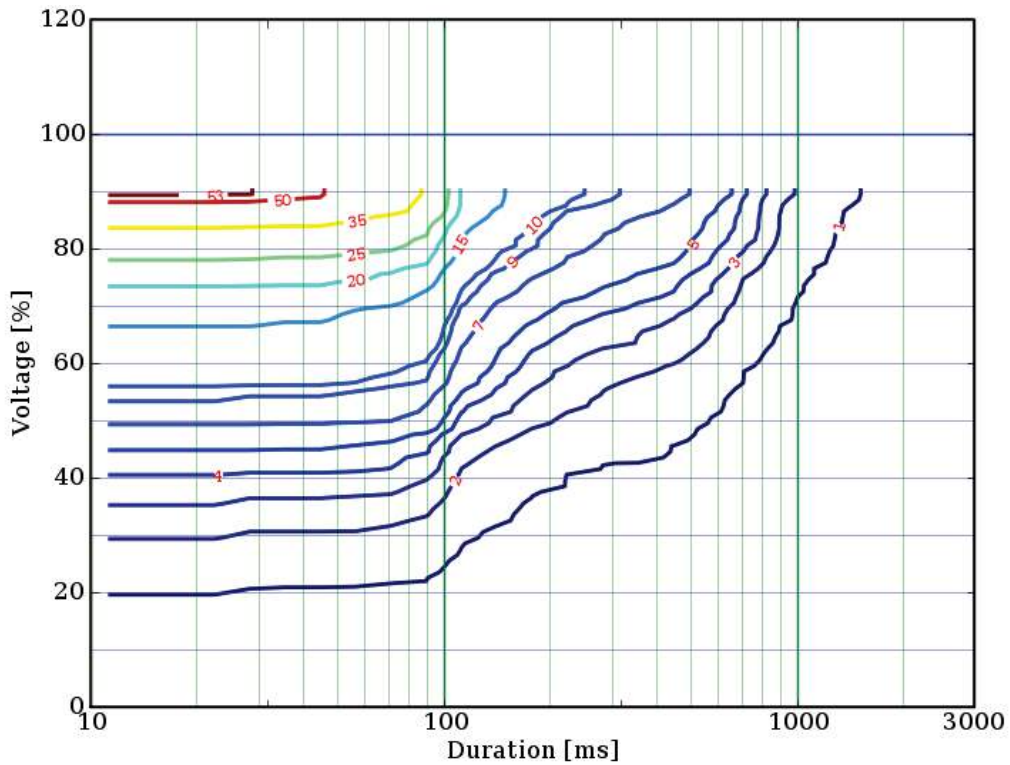

Figure 6-14 MV and HV sites, "MANY" scope (3 voltage channels recorded), only type I dips, 90% best sites.

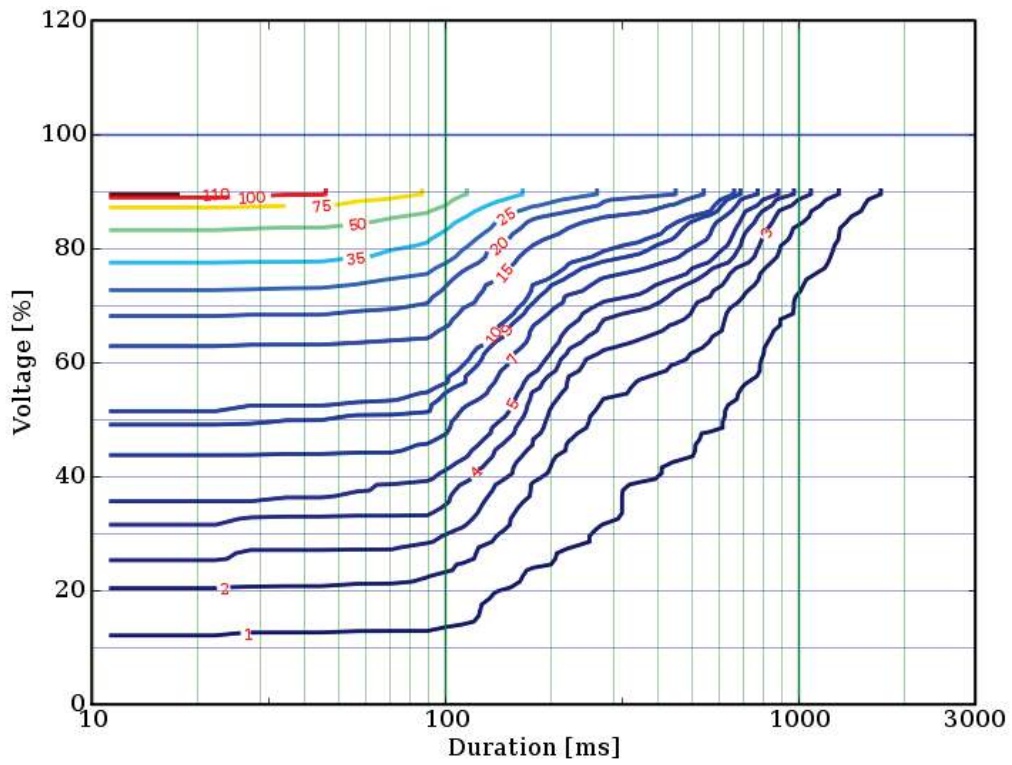

Figure 6-15 MV and HV sites, "MANY" scope (3 voltage channels recorded), only type II dips, 90% best sites.

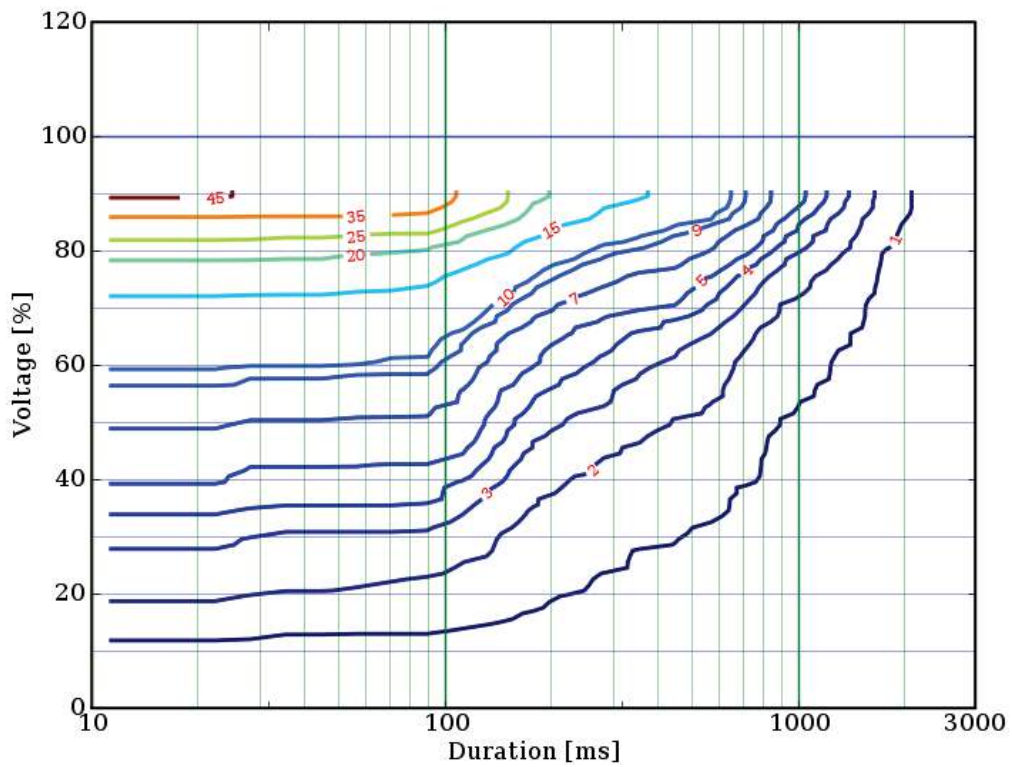

Figure 6-16 MV and HV sites, "MANY" scope (3 voltage channels recorded), only type III dips, 90% best sites.

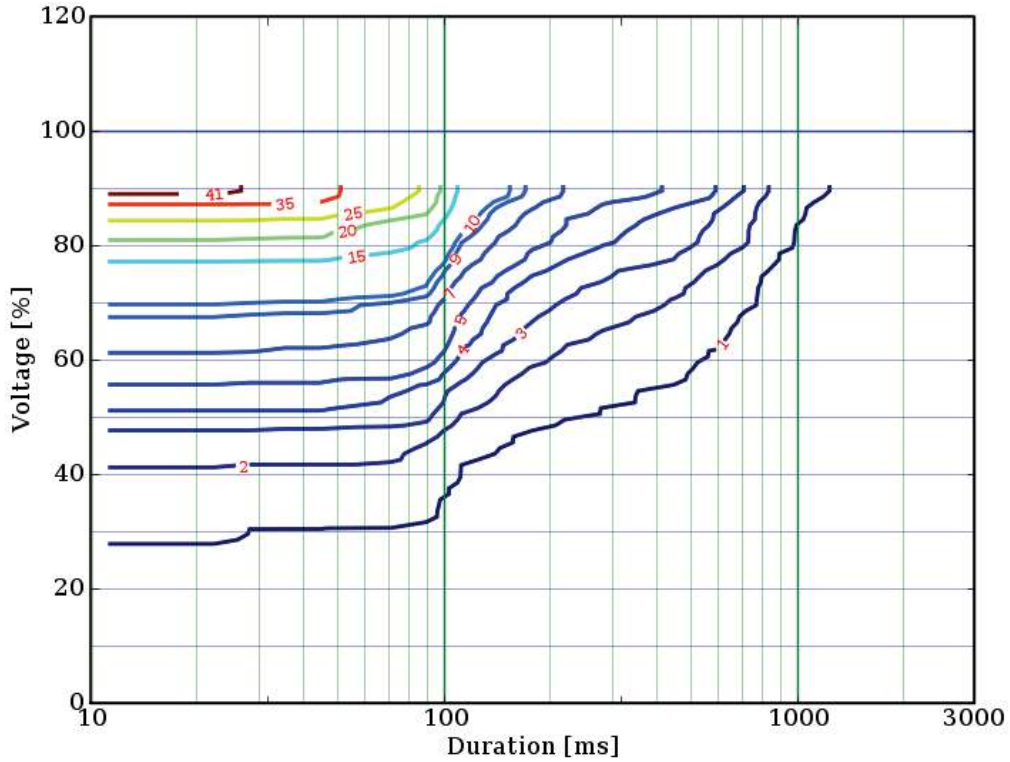

Figure 6-17 MV and HV sites, "MANY" scope (3 voltage channels recorded), type I and (3A) shape at the same time, 90% best sites.

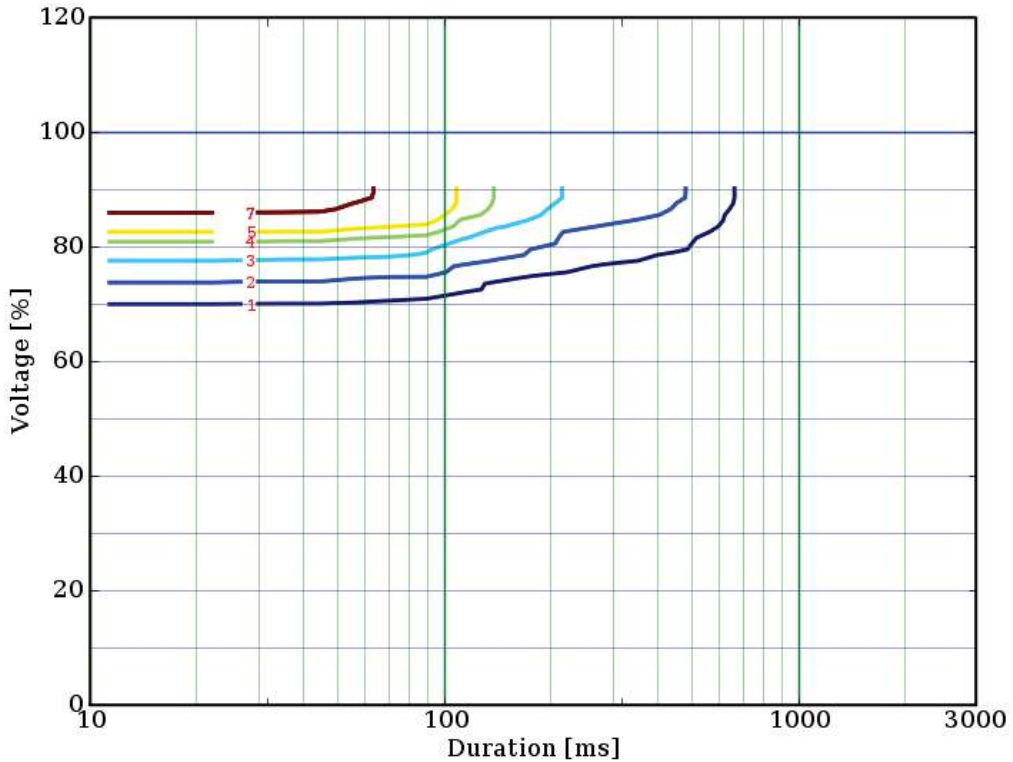

Figure 6-18 MV and HV sites, "MANY" scope (3 voltage channels recorded), type I and (3B) shape at the same time, 90% best sites.

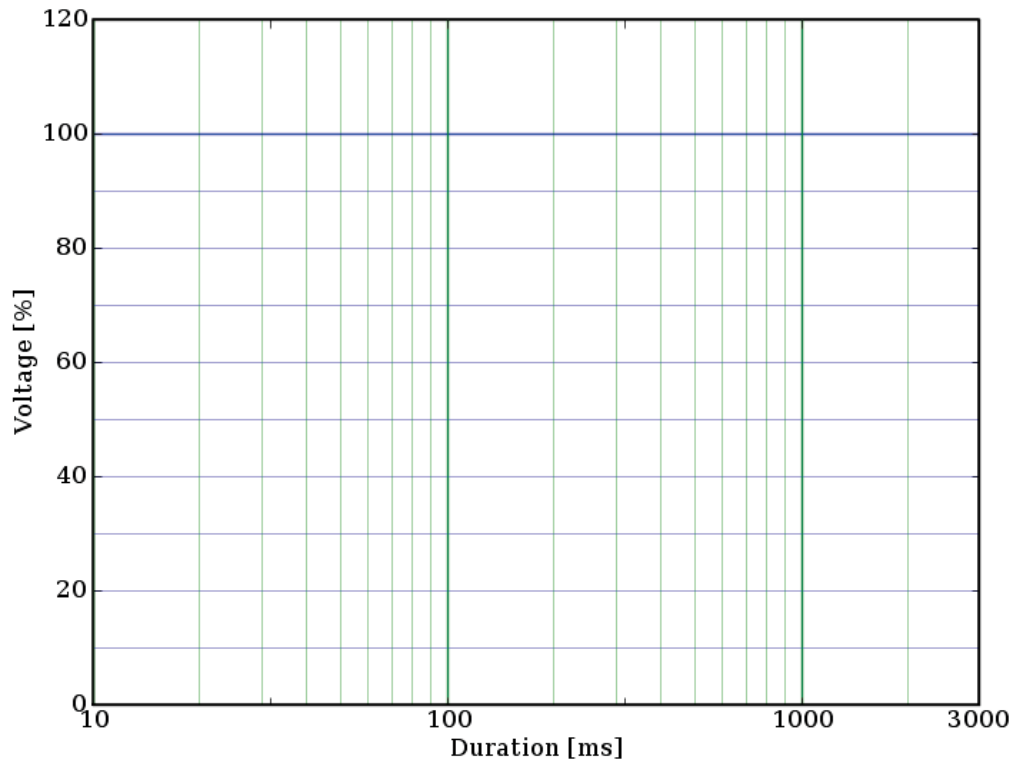

Figure 6-19 MV and HV sites, "MANY" scope (3 voltage channels recorded), type I and (3C) shape at the same time, 90% best sites.

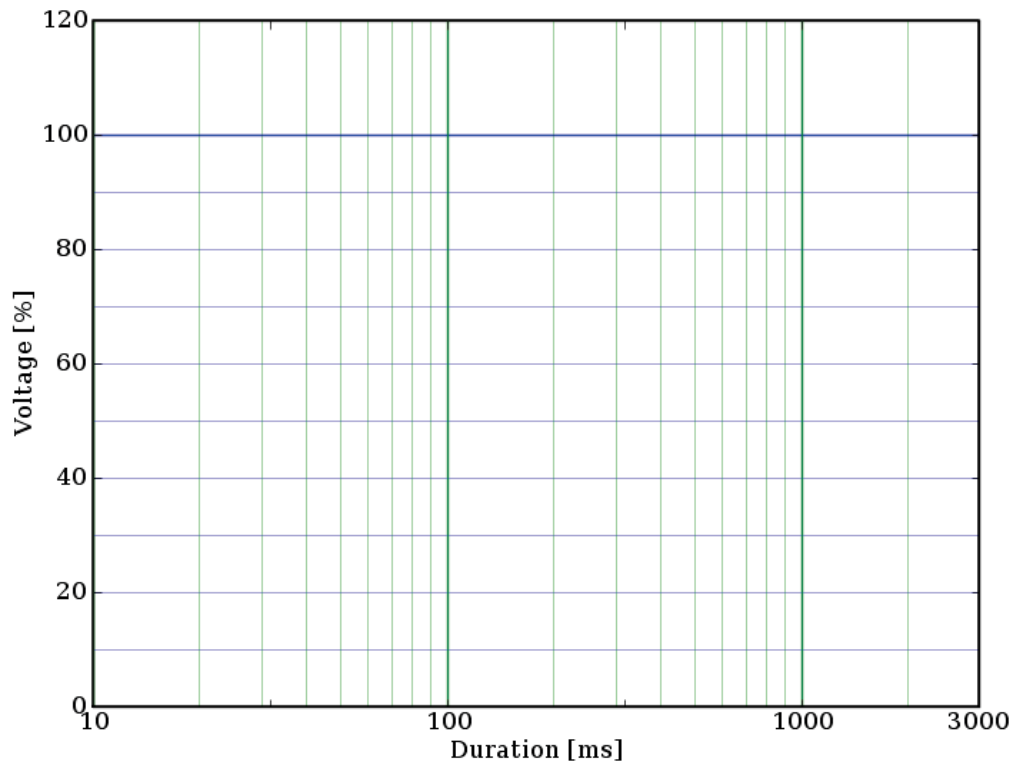

Figure 6-20 MV and HV sites, "MANY" scope (3 voltage channels recorded), type II and (3A) shape at the same time, 90% best sites.

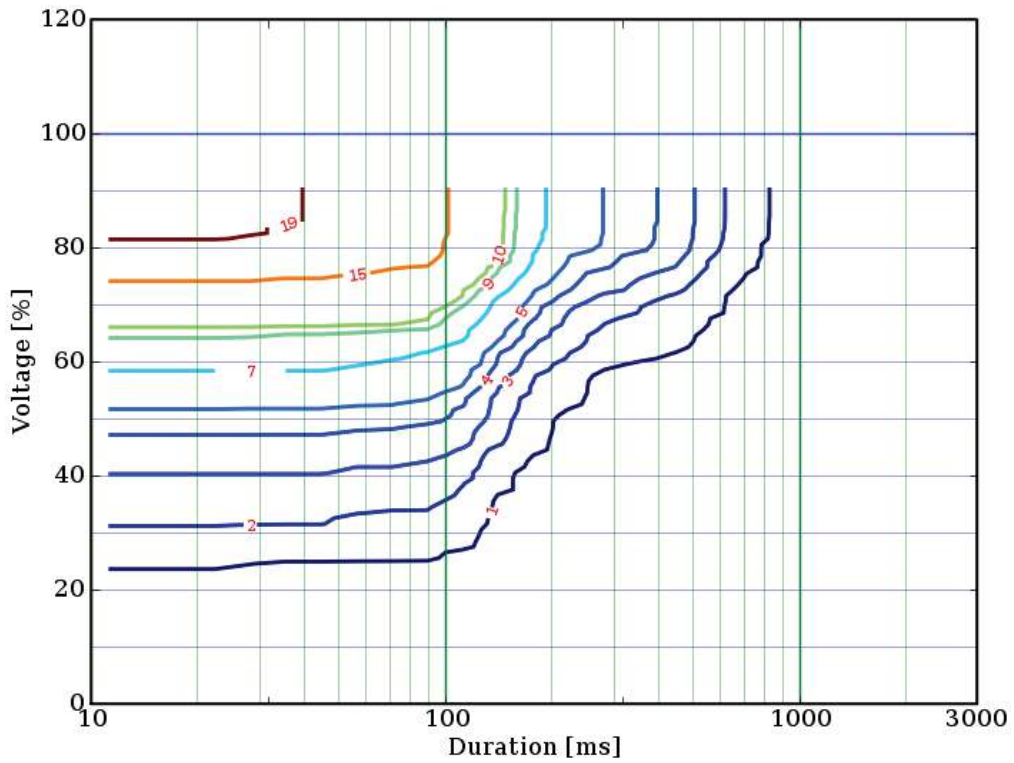

Figure 6-21 MV and HV sites, "MANY" scope (3 voltage channels recorded), type II and (3B) shape at the same time, 90% best sites.

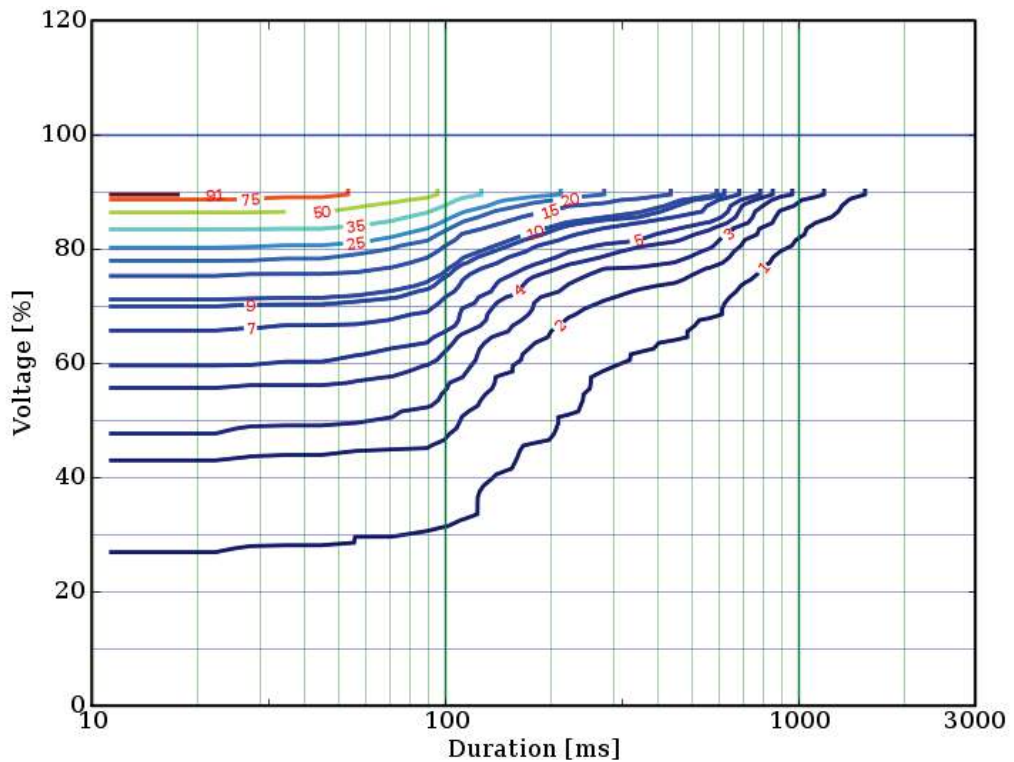

Figure 6-22 MV and HV sites, "MANY" scope (3 voltage channels recorded), type II and (3C) shape at the same time, 90% best sites.

6.5.3 Contour charts for the HV/MV 75% best sites, "MANY" scope

The contour charts for the 75% site over the HV/MV sites are shown in Figure 6-23 through 6-32. For each voltage-duration point the worst 25% of the sites are disregarded.

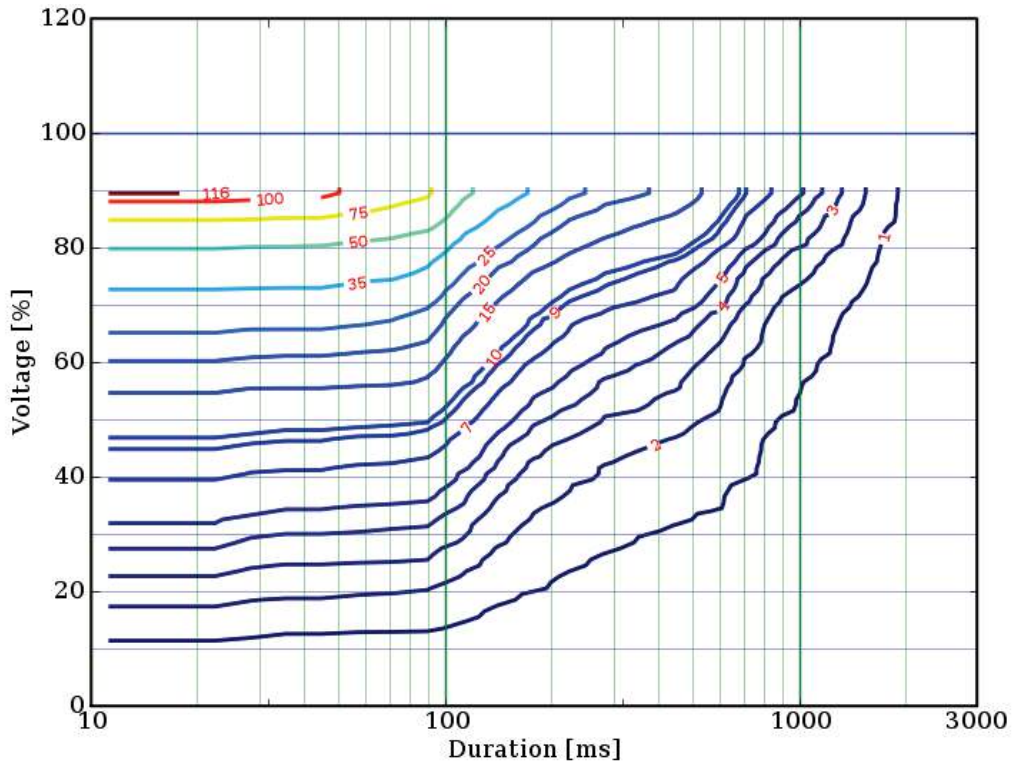

Figure 6-23 MV and HV sites, "MANY" scope (3 voltage channels recorded), 75% best sites.

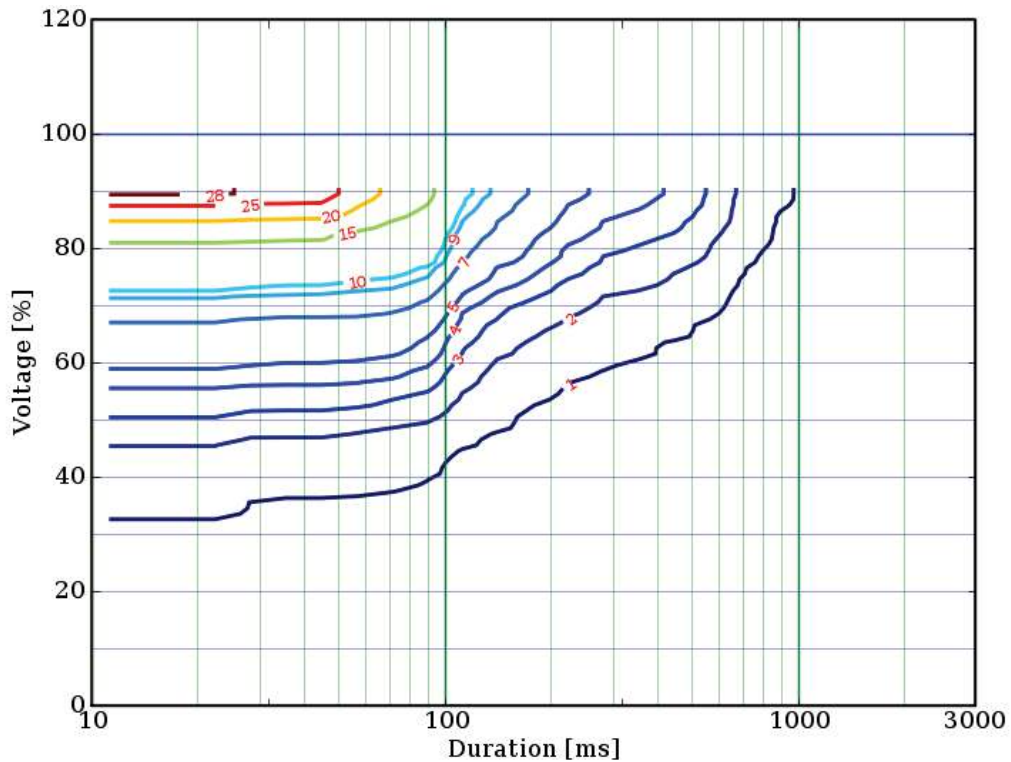

Figure 6-24 MV and HV sites, "MANY" scope (3 voltage channels recorded), only type I dips, 75% best sites.

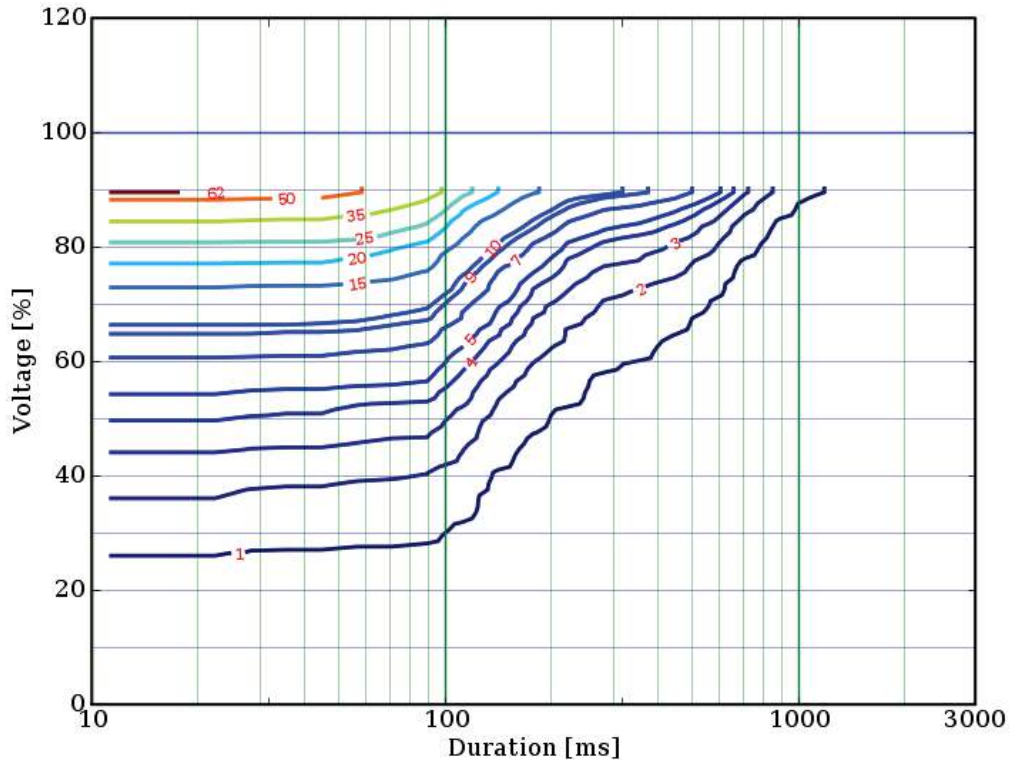

Figure 6-25 MV and HV sites, "MANY" scope (3 voltage channels recorded), only type II dips, 75% best sites.

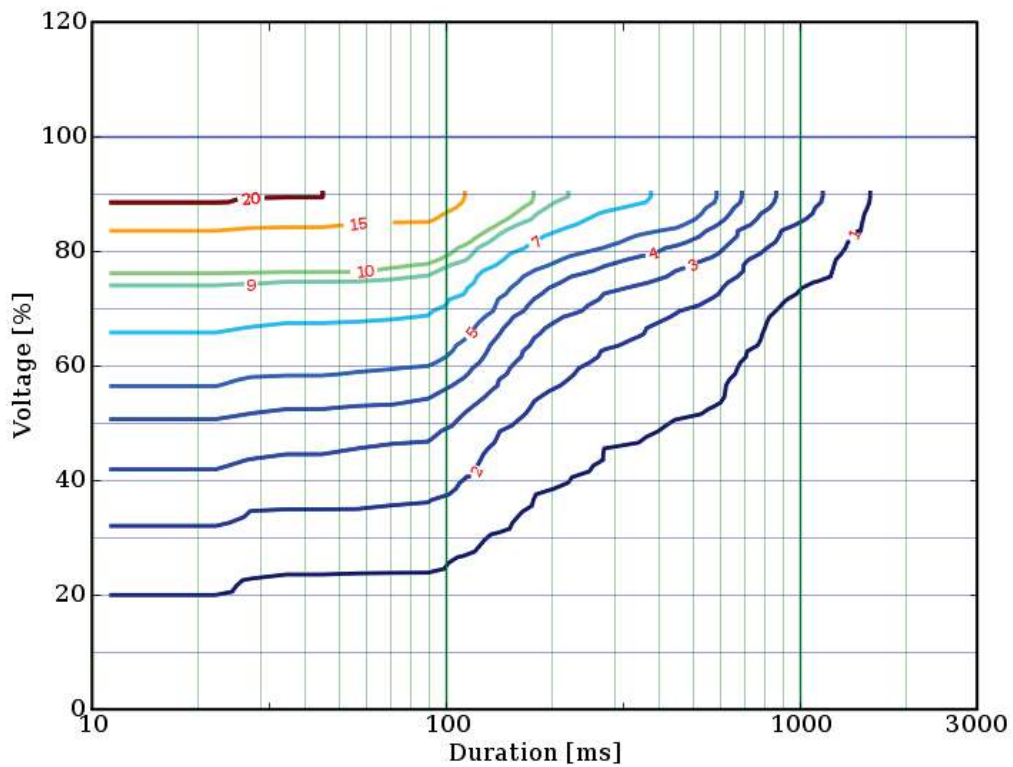

Figure 6-26 MV and HV sites, "MANY" scope (3 voltage channels recorded), only type III dips, 75% best sites.

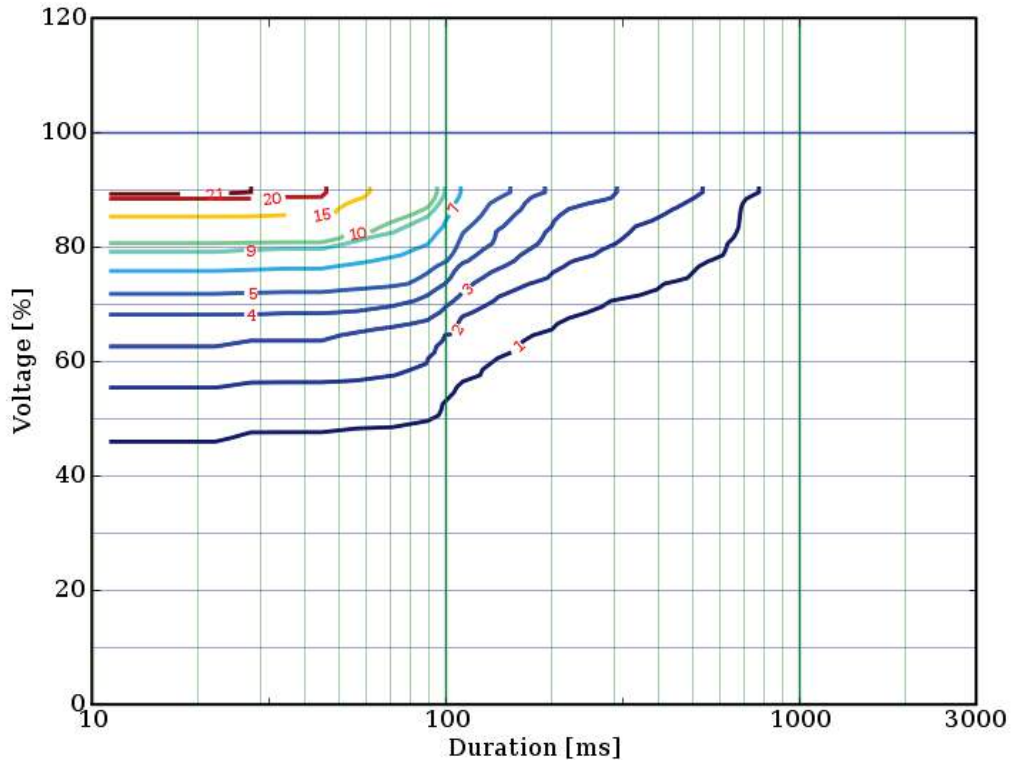

Figure 6-27 MV and HV sites, "MANY" scope (3 voltage channels recorded), type I and (3A) shape at the same time, 75% best sites.

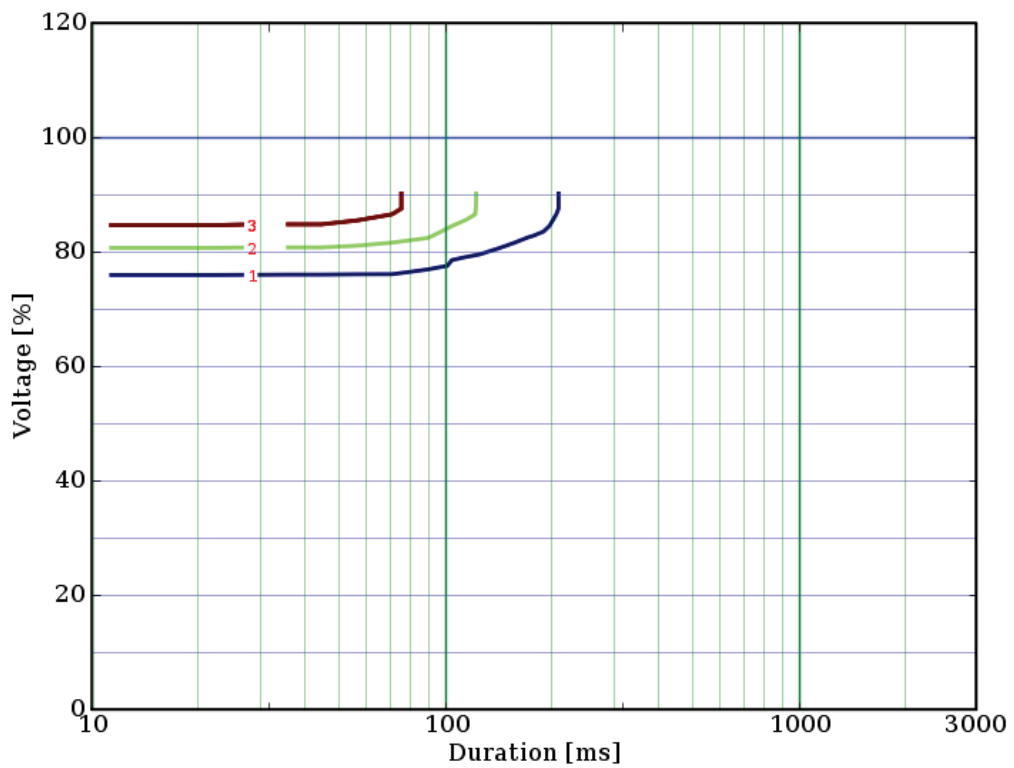

Figure 6-28 MV and HV sites, "MANY" scope (3 voltage channels recorded), type I and (3B) shape at the same time, 75% best sites.

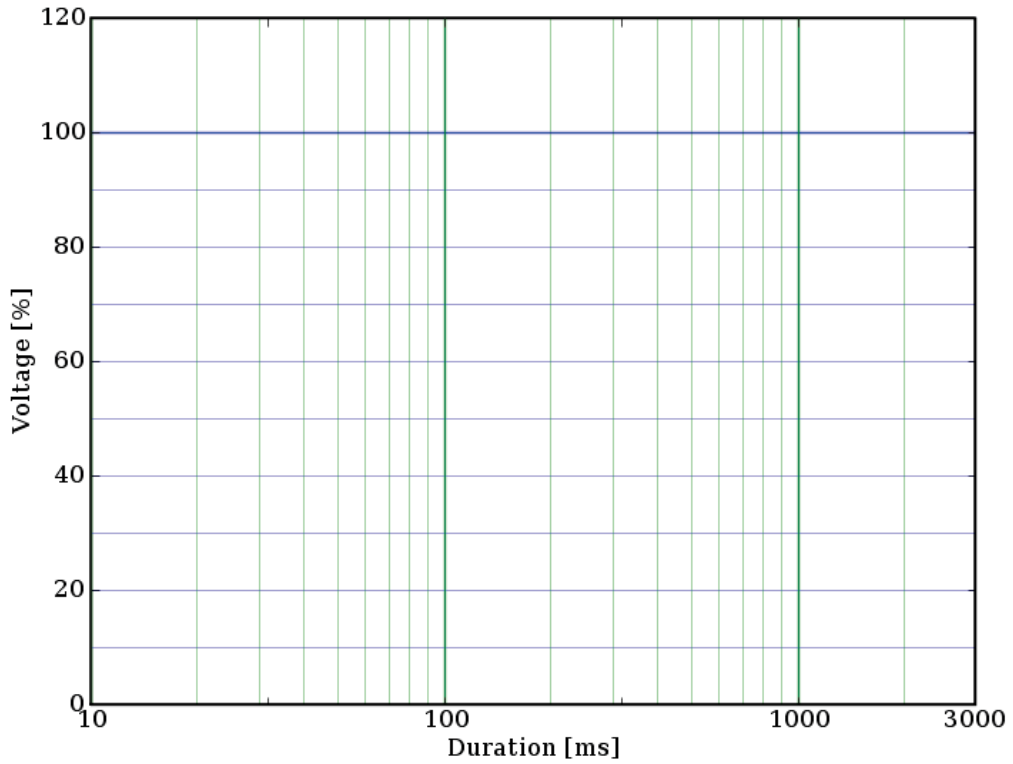

Figure 6-29 MV and HV sites, "MANY" scope (3 voltage channels recorded), type I and (3C) shape at the same time, 75% best sites.

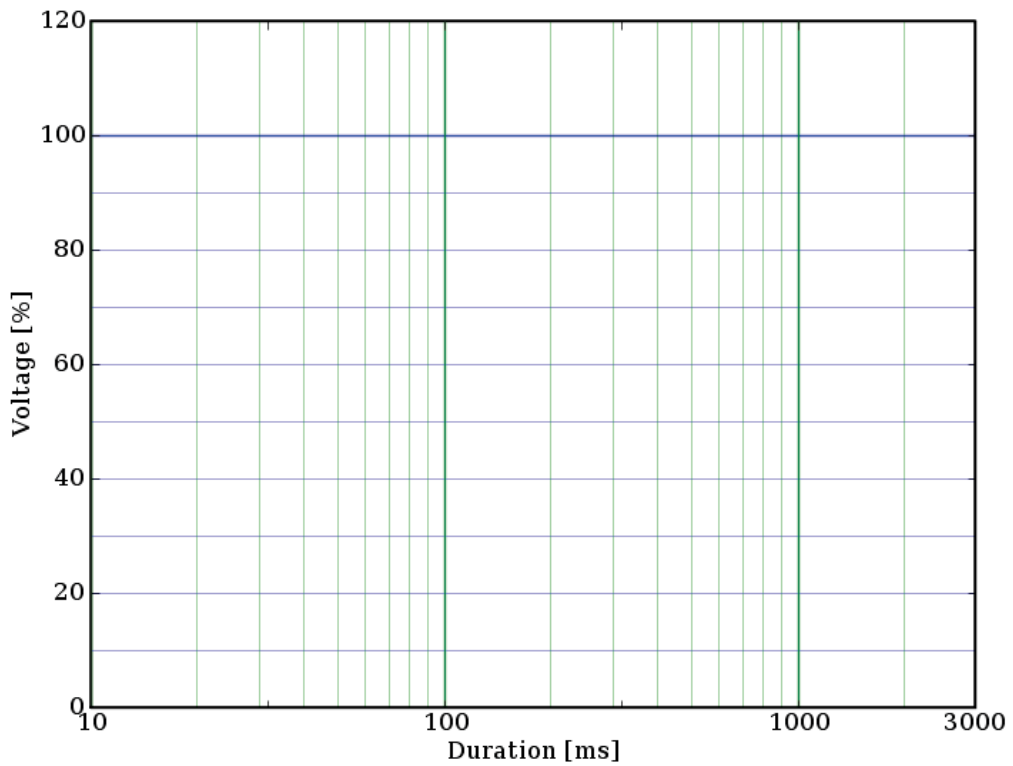

Figure 6-30 MV and HV sites, "MANY" scope (3 voltage channels recorded), type II and (3A) shape at the same time, 75% best sites.

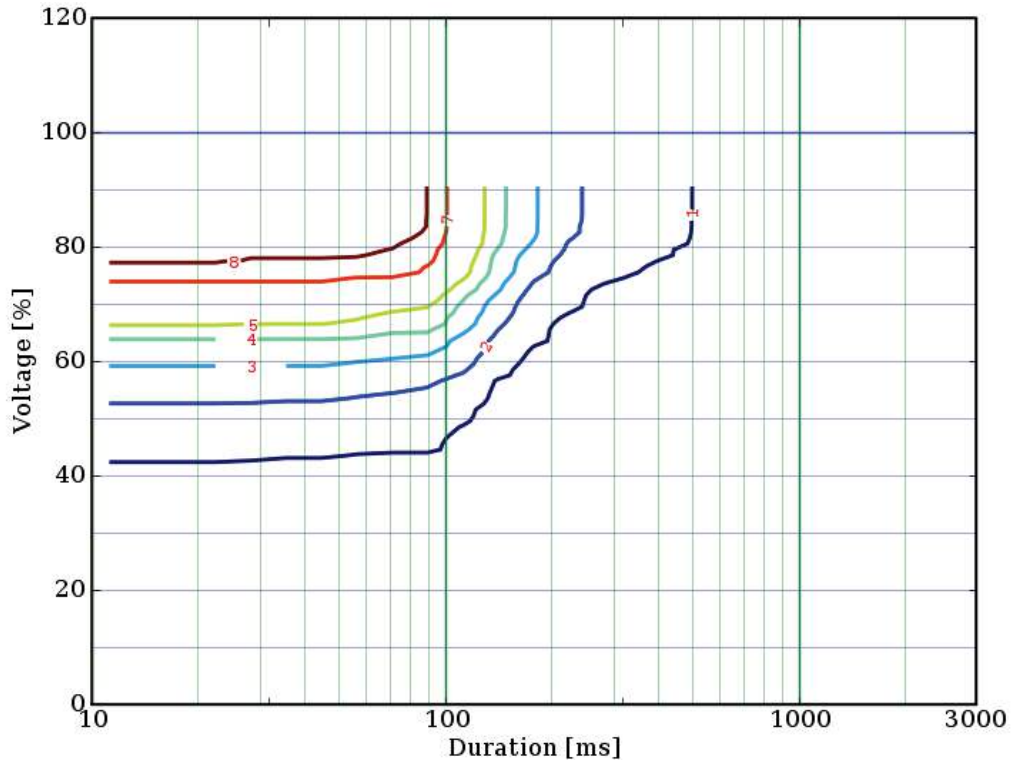

Figure 6-31 MV and HV sites, "MANY" scope (3 voltage channels recorded), type II and (3B) shape at the same time, 75% best sites.

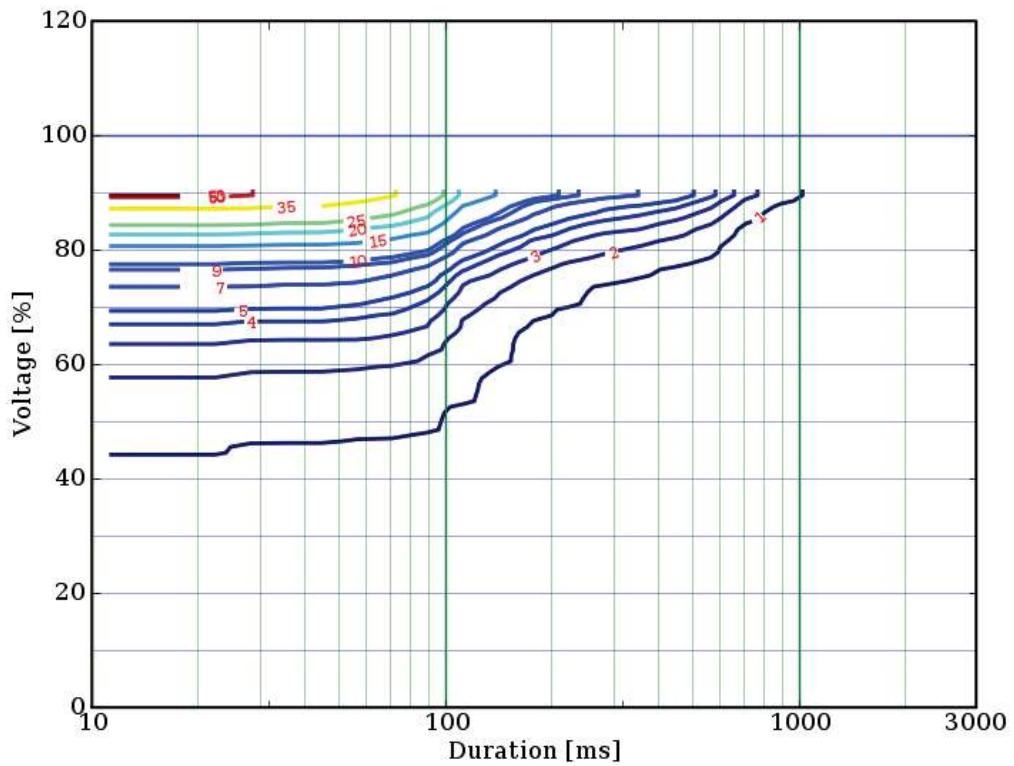

Figure 6-32 MV and HV sites, "MANY" scope (3 voltage channels recorded), type II and (3C) shape at the same time, 75% best sites.

6.5.4 Contour charts for the 50% best sites (median value), "MANY" scope

The contour charts for the 50% site over the HV/MV sites are shown in Figure 6-33 through 6-42. For each voltage-duration point the worst 50% of the sites are disregarded.

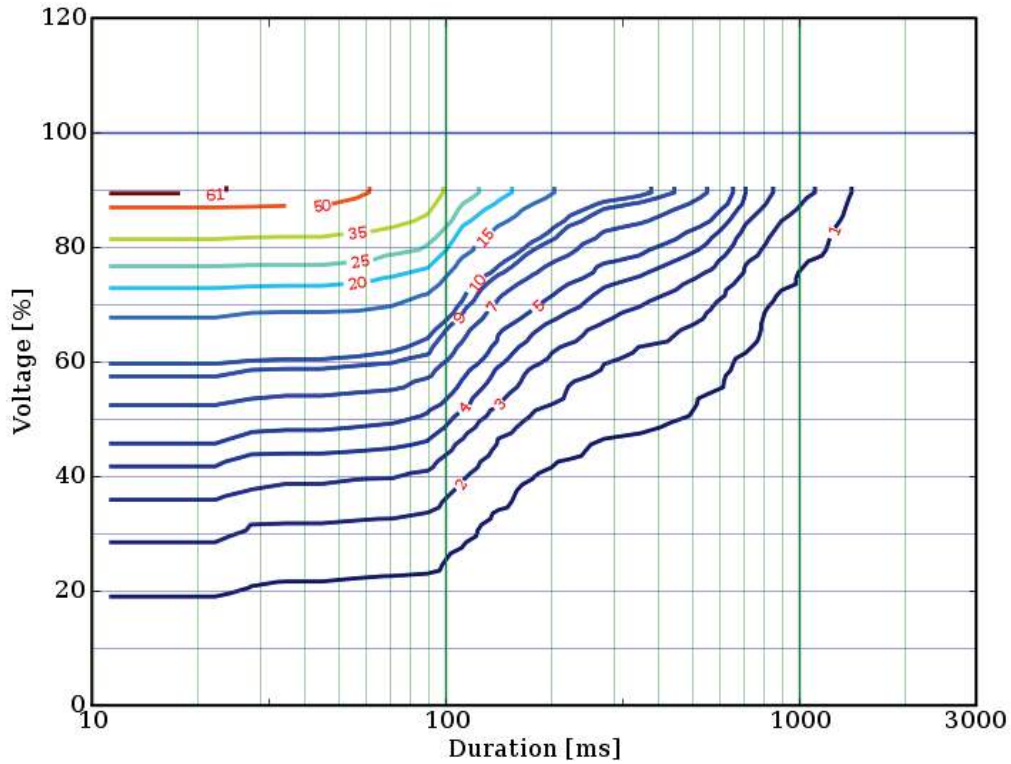

Figure 6-33 MV and HV sites, "MANY" scope (3 voltage channels recorded), 50% best sites.

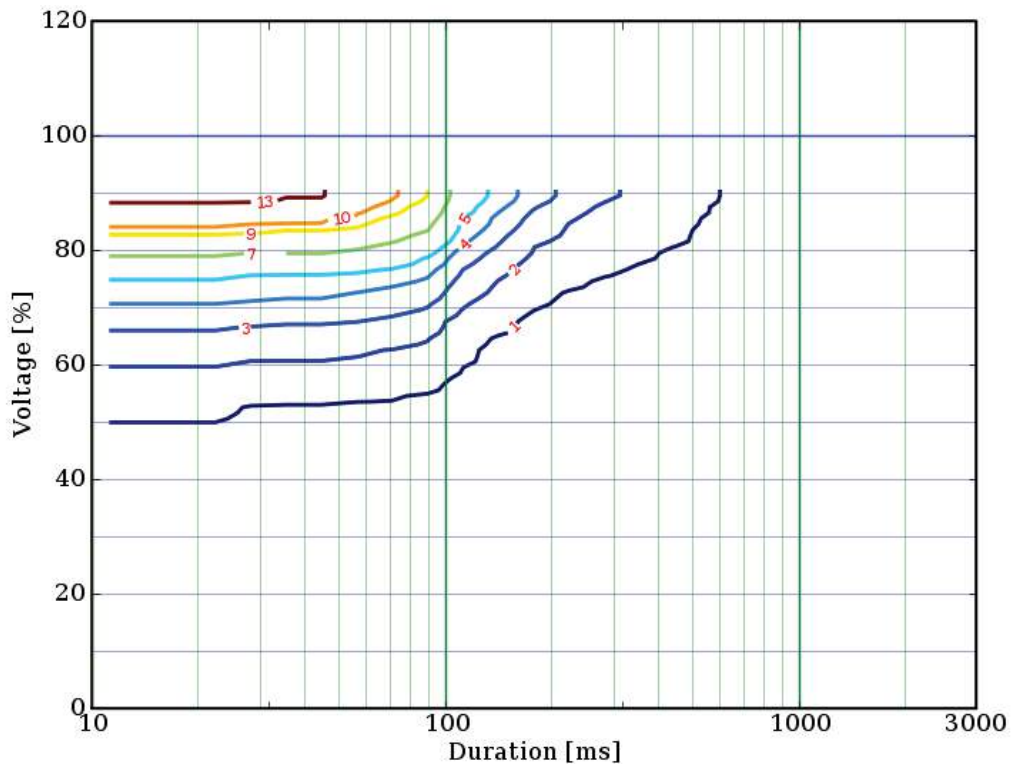

Figure 6-34 MV and HV sites, "MANY" scope (3 voltage channels recorded), only type I dips, 50% best sites.

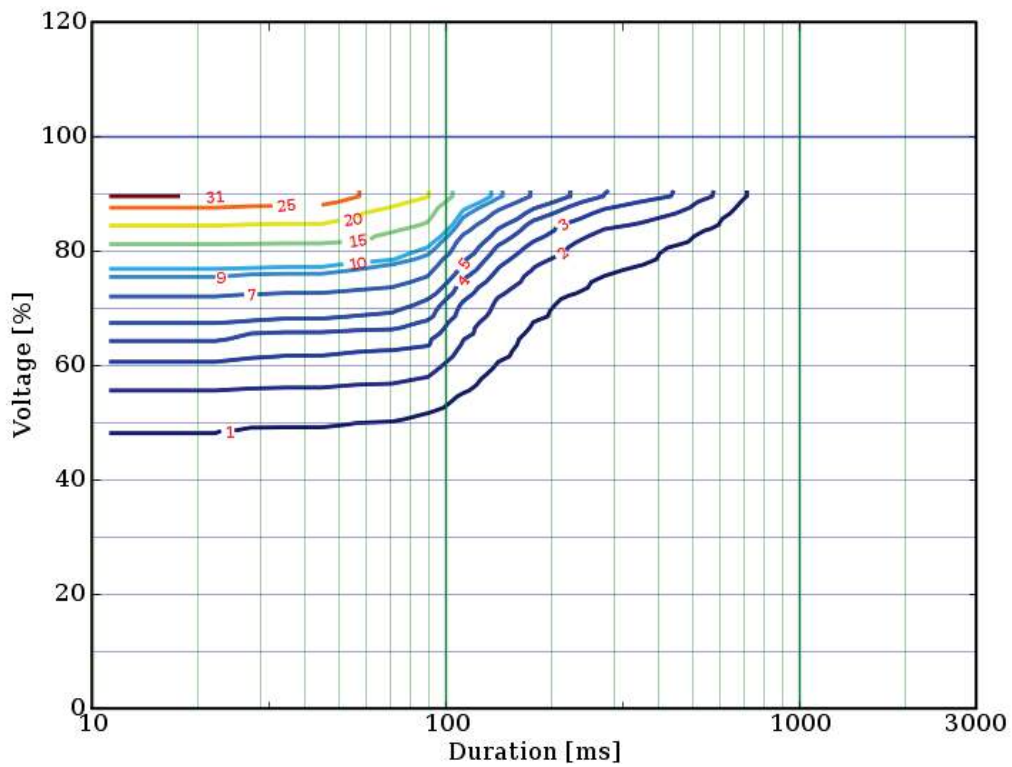

Figure 6-35 MV and HV sites, "MANY" scope (3 voltage channels recorded), only type II dips, 50% best sites.

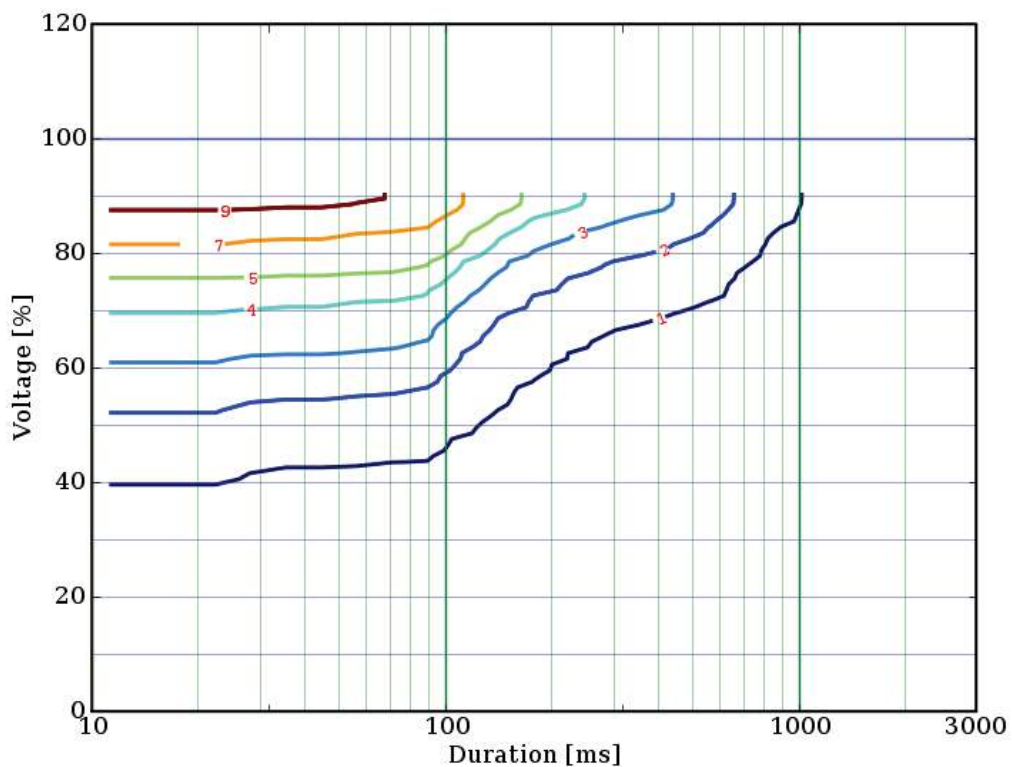

Figure 6-36 MV and HV sites, "MANY" scope (3 voltage channels recorded), only type III dips, 50% best sites.

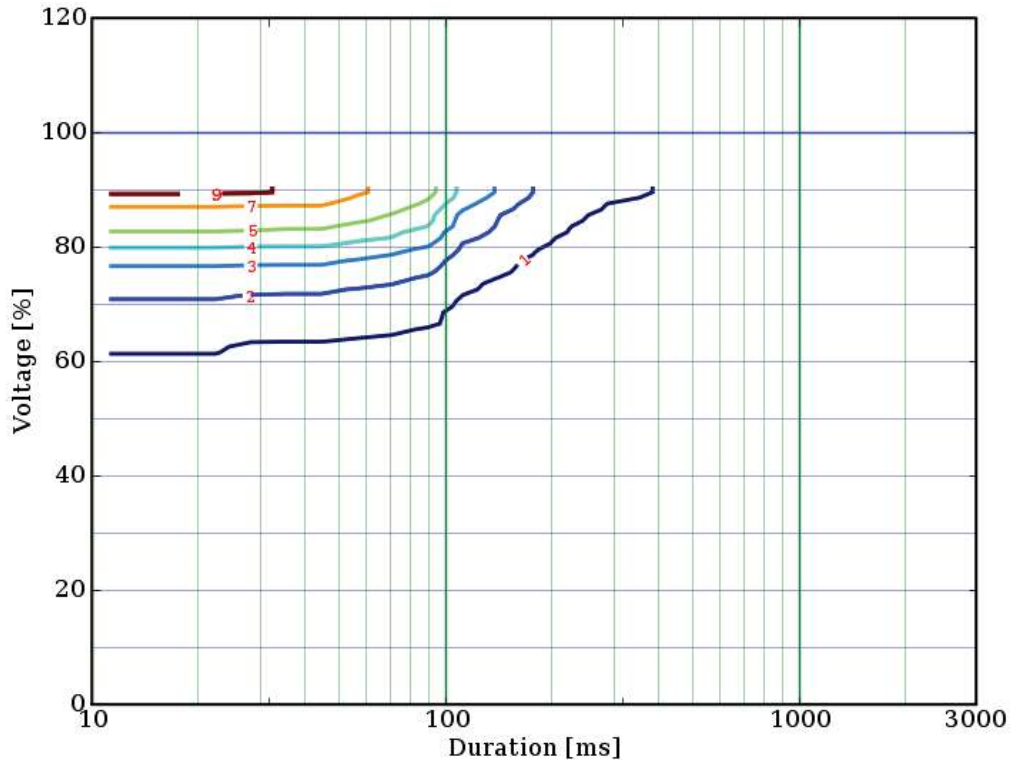

Figure 6-37 MV and HV sites, "MANY" scope (3 voltage channels recorded), type I and (3A) shape at the same time, 50% best sites.

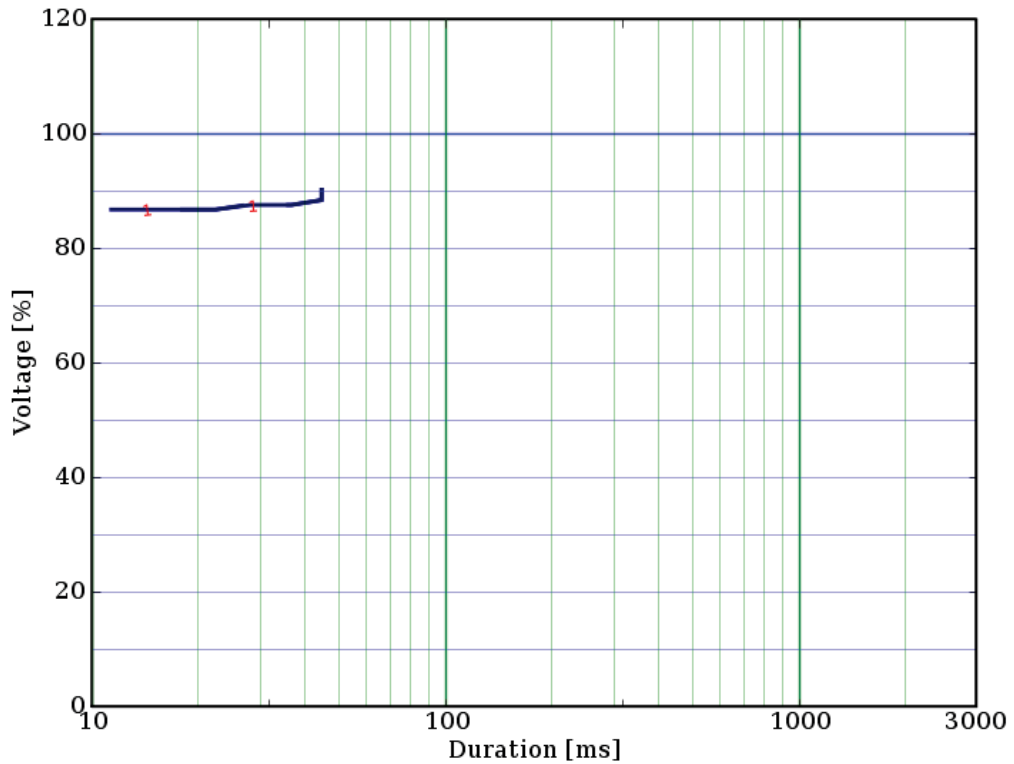

Figure 6-38 MV and HV sites, "MANY" scope (3 voltage channels recorded), type I and (3B) shape at the same time, 50% best sites.

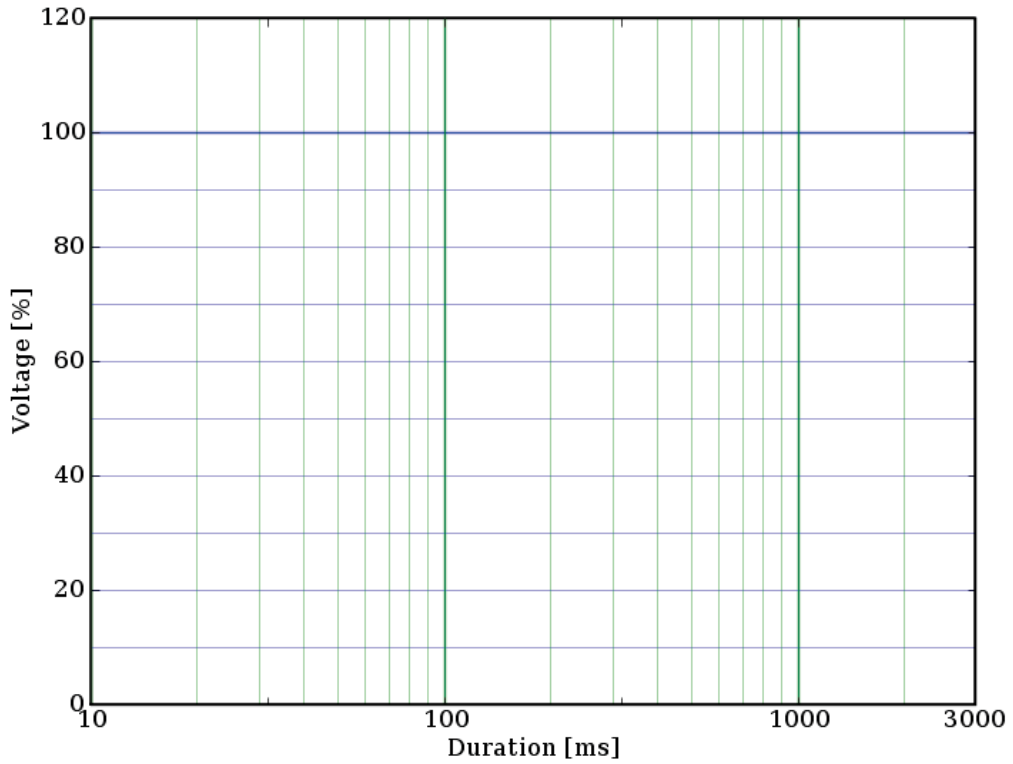

Figure 6-39 MV and HV sites, "MANY" scope (3 voltage channels recorded), type I and (3C) shape at the same time, 50% best sites.

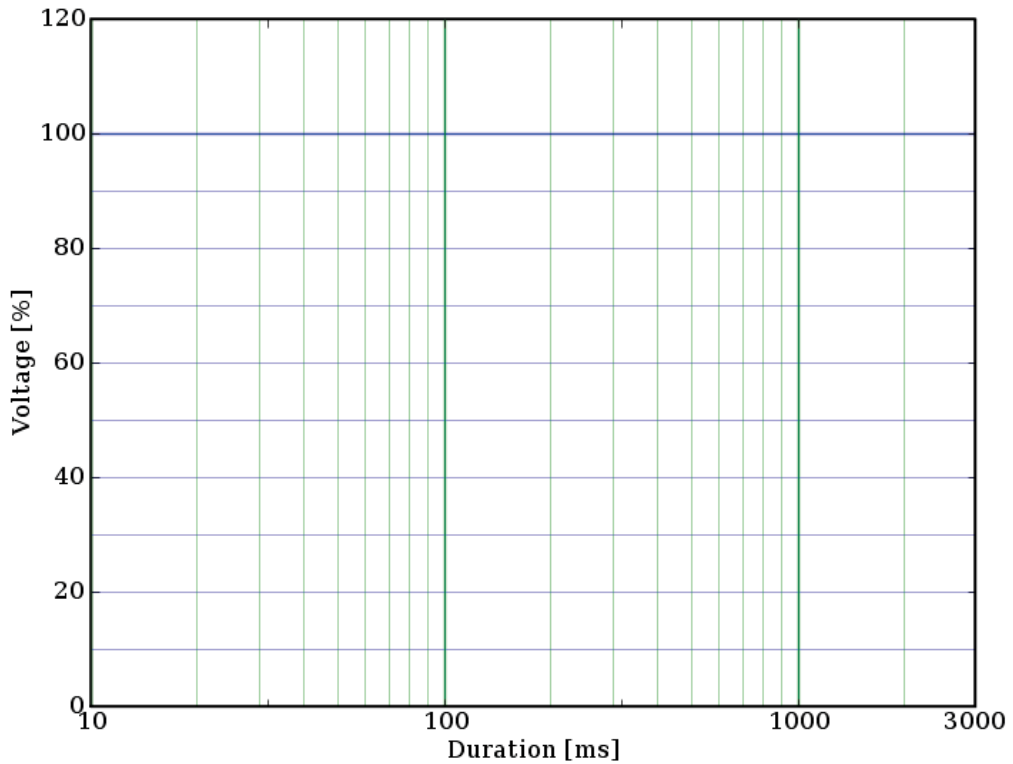

Figure 6-40 MV and HV sites, "MANY" scope (3 voltage channels recorded), type II and (3A) shape at the same time, 50% best sites.

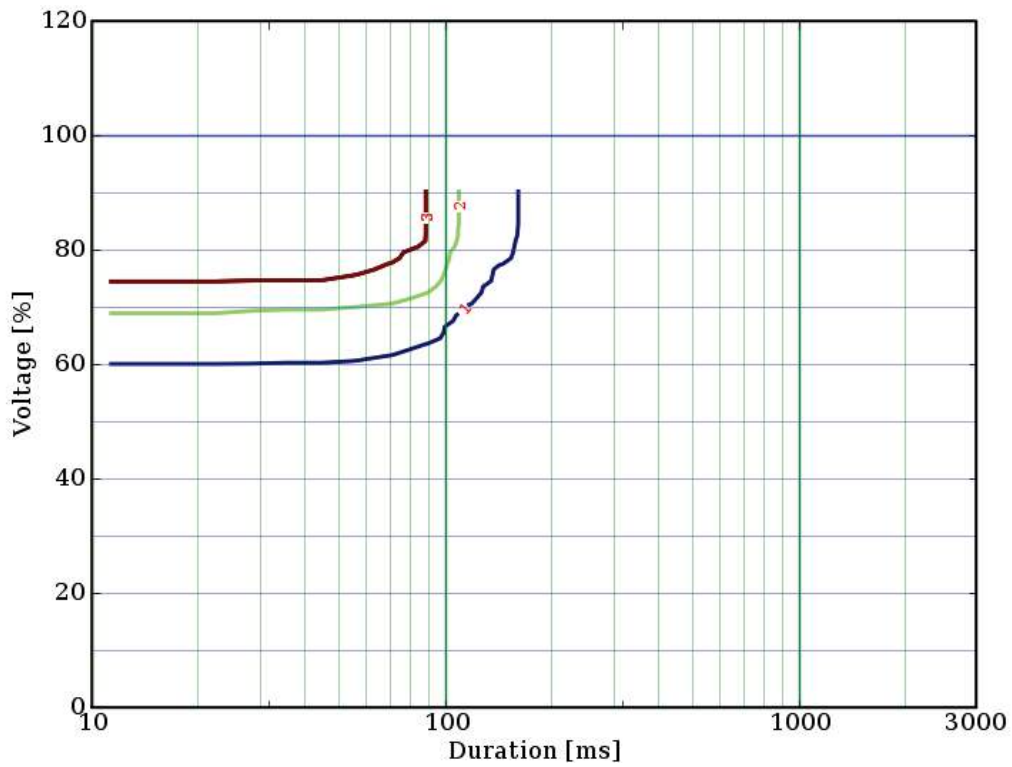

Figure 6-41 MV and HV sites, "MANY" scope (3 voltage channels recorded), type II and (3B) shape at the same time, 50% best sites.

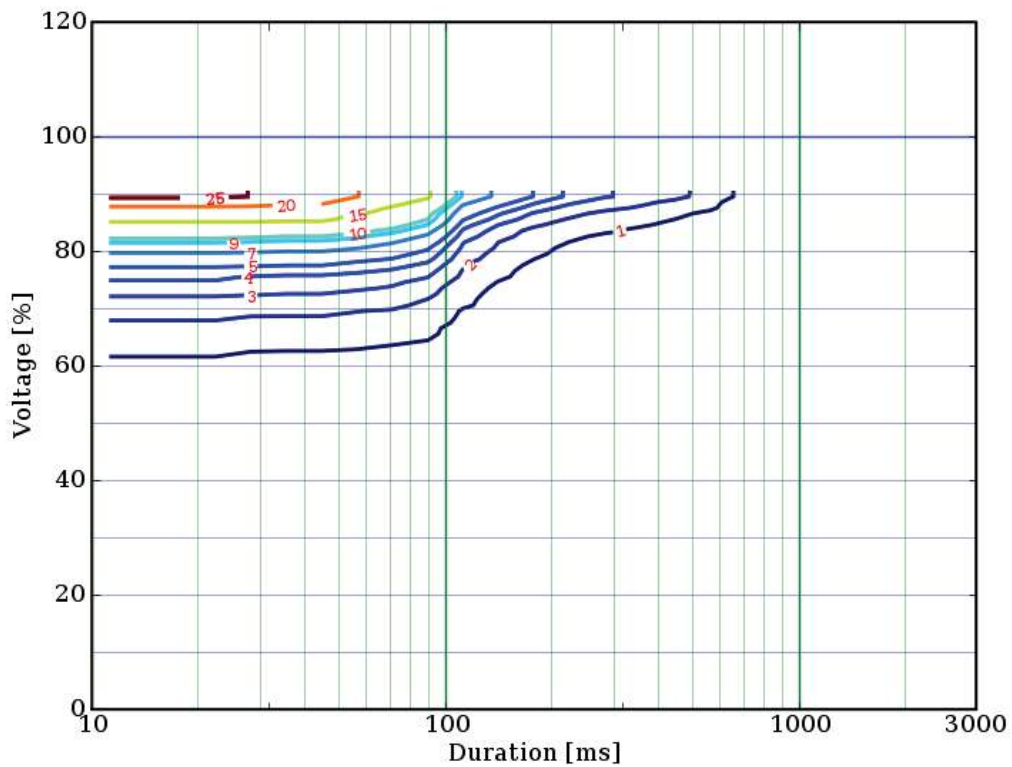

Figure 6-42 MV and HV sites, "MANY" scope (3 voltage channels recorded), type II and (3C) shape at the same time, 50% best sites.

6.5.5 Contour charts for the HV/MV 25% best sites, "MANY" scope

The contour charts for the 925% site over the HV/MV sites are shown in Figure 6-43 through 6-52. For each voltage-duration point the worst 75% of the sites are disregarded.

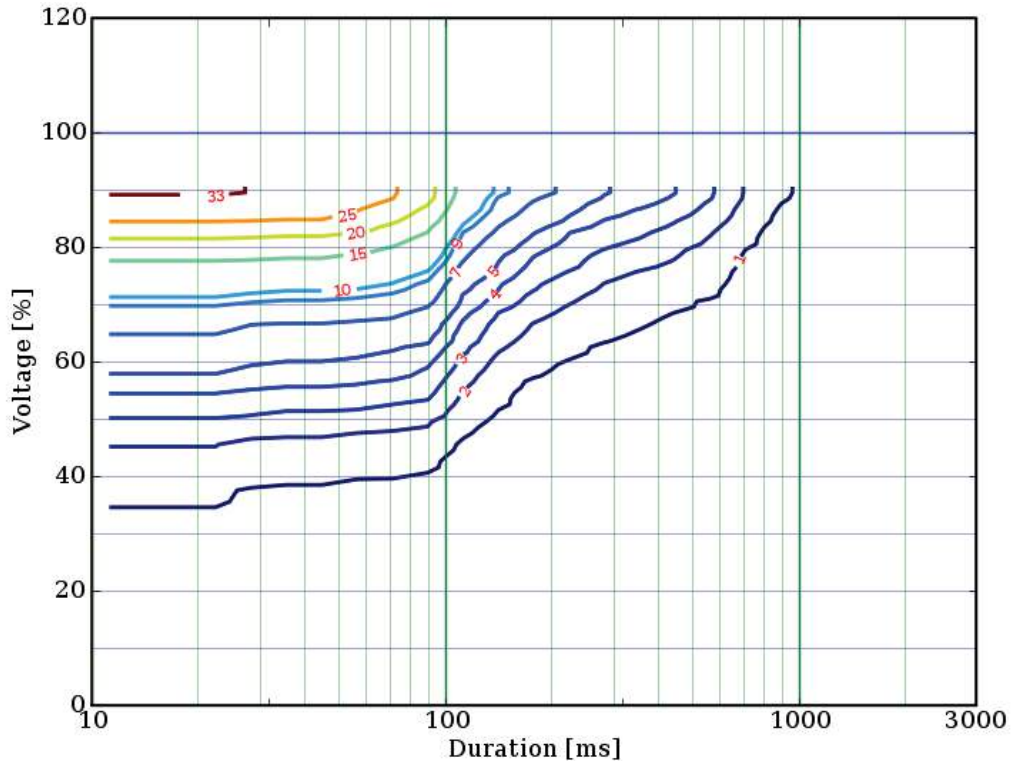

Figure 6-43 MV and HV sites, "MANY" scope (3 voltage channels recorded), 25% best sites.

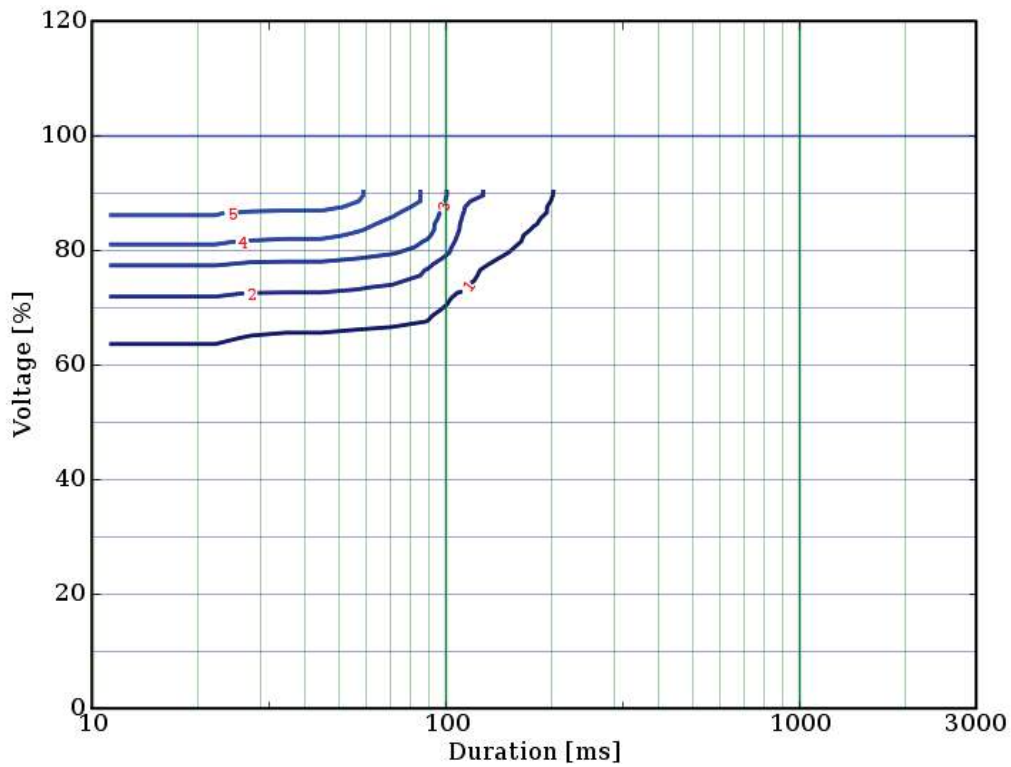

Figure 6-44 MV and HV sites, "MANY" scope (3 voltage channels recorded), only type I dips, 25% best sites.

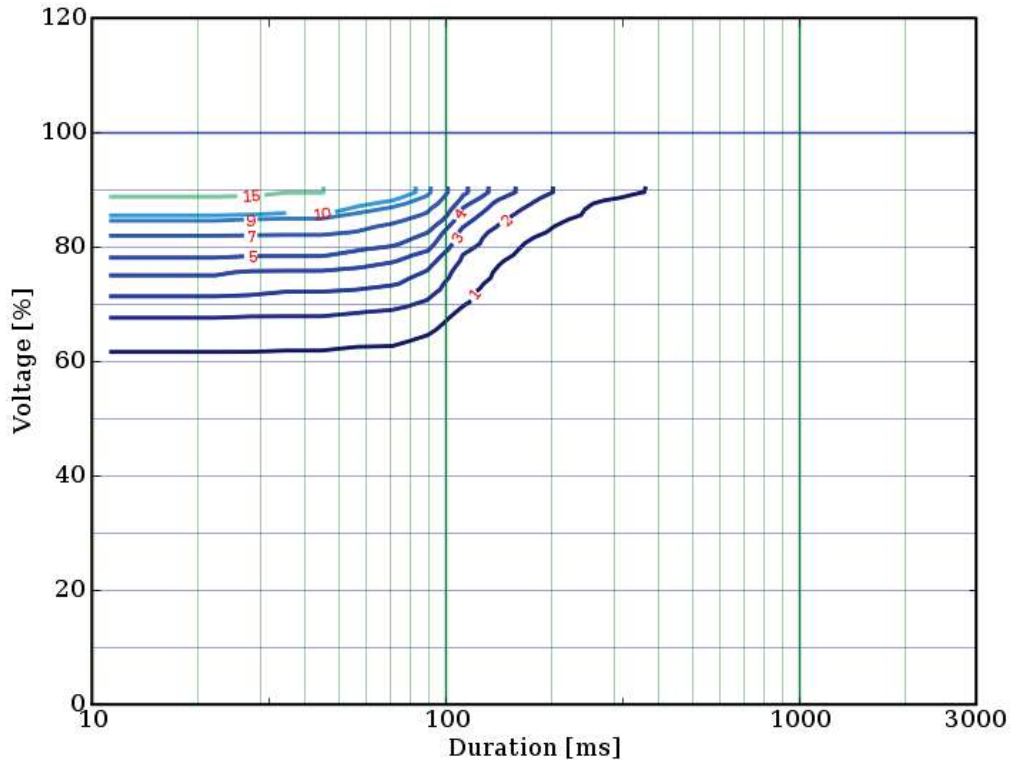

Figure 6-45 MV and HV sites, "MANY" scope (3 voltage channels recorded), only type II dips, 25% best sites.

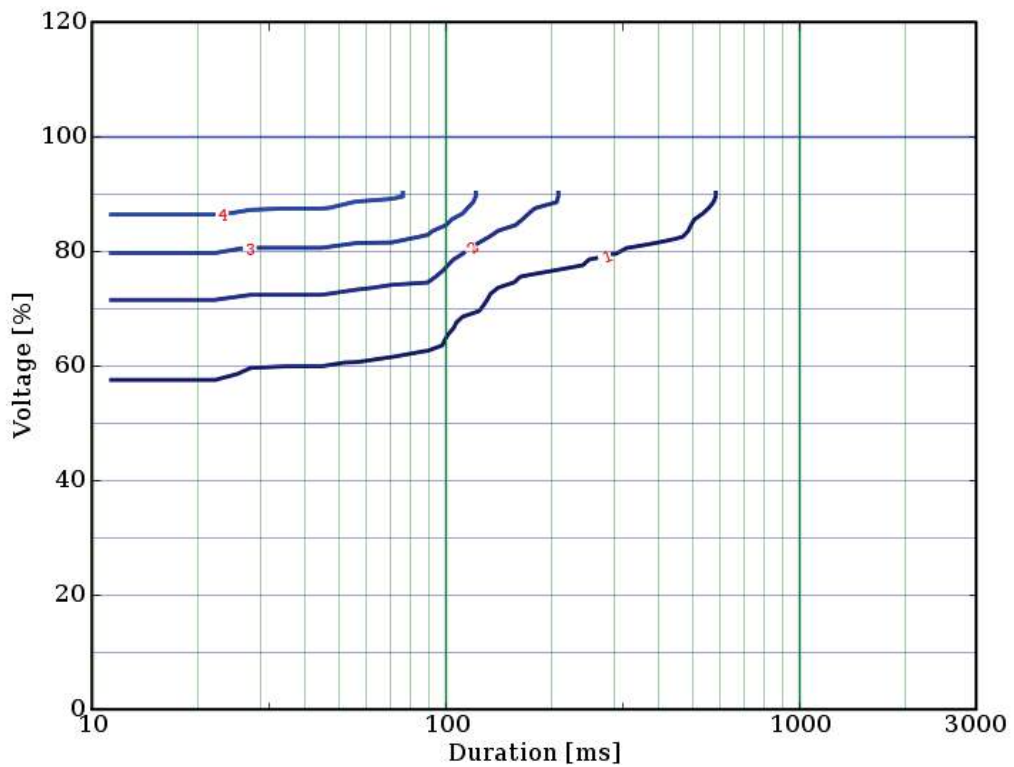

Figure 6-46 MV and HV sites, "MANY" scope (3 voltage channels recorded), only type III dips, 25% best sites.

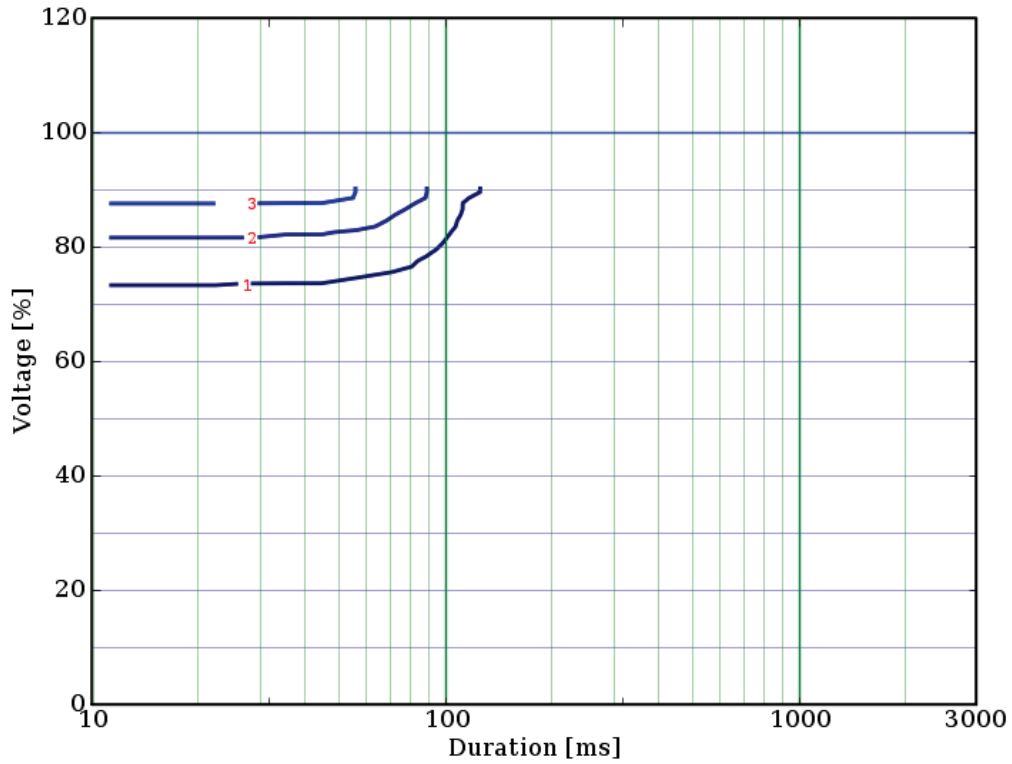

Figure 6-47 MV and HV sites, "MANY" scope (3 voltage channels recorded), type I and (3A) shape at the same time, 25% best sites.

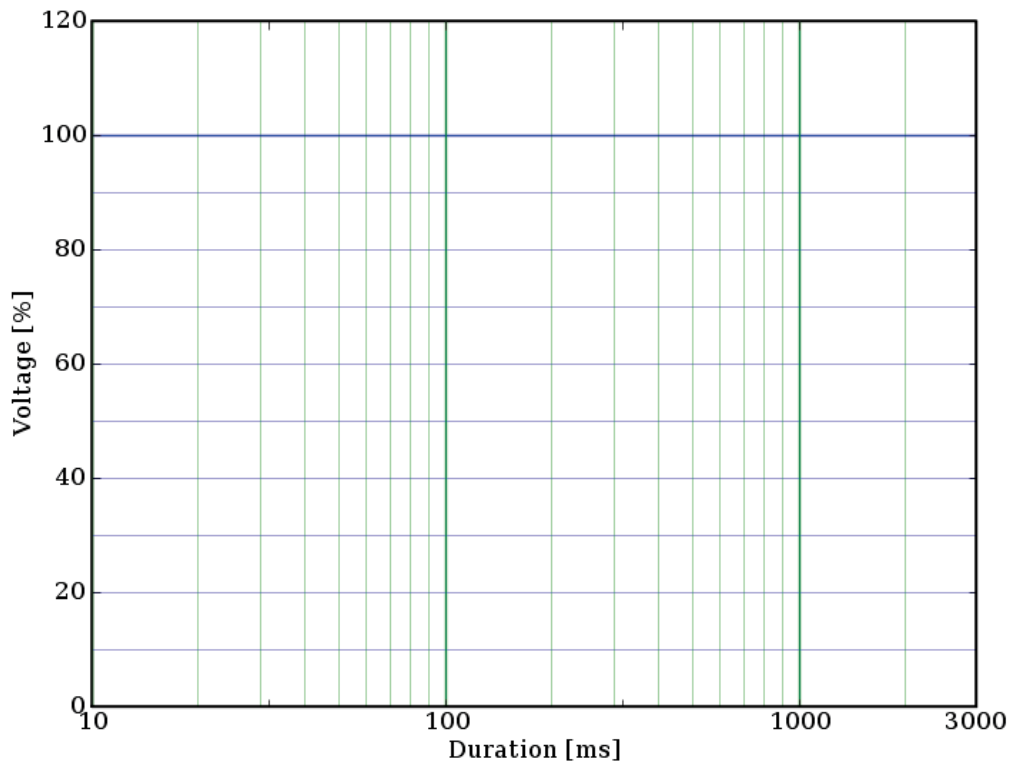

Figure 6-48 MV and HV sites, "MANY" scope (3 voltage channels recorded), type I and (3B) shape at the same time, 25% best sites.

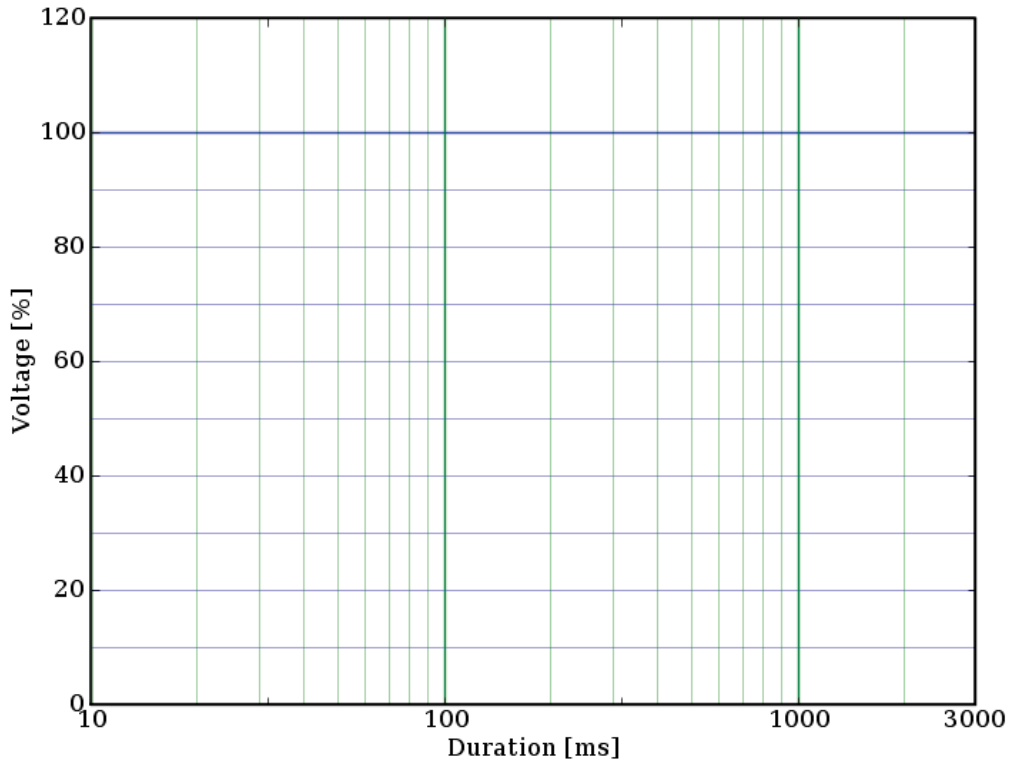
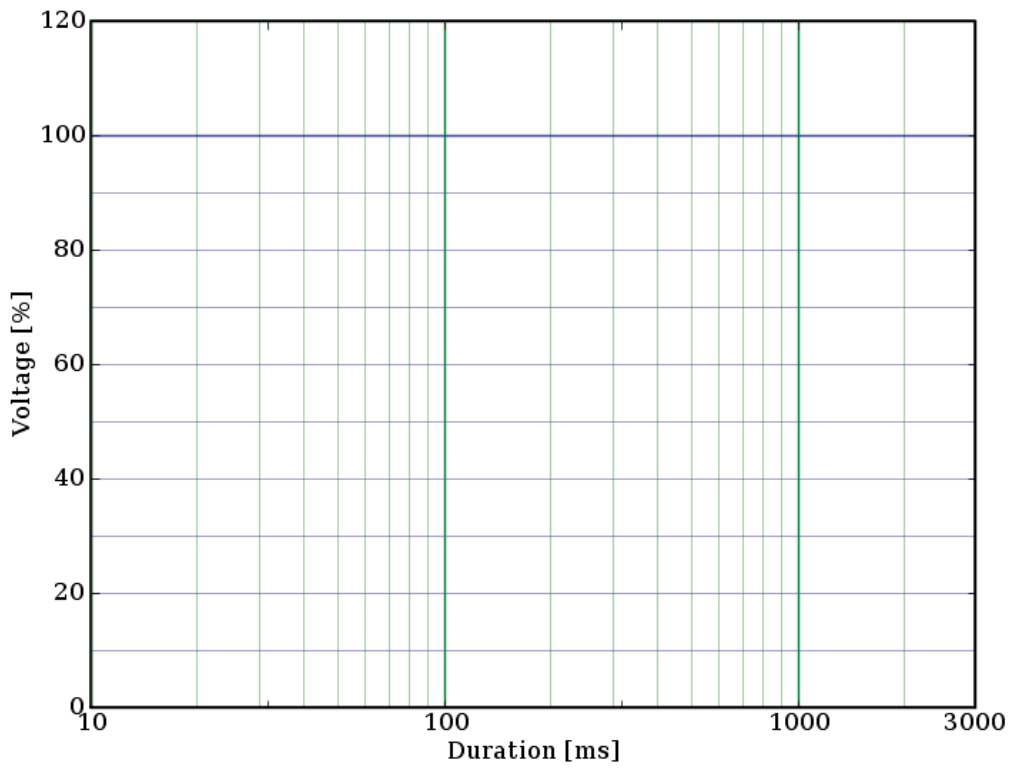

Figure 6-49 MV and HV sites, "MANY" scope (3 voltage channels recorded), type I and (3C) shape at the same time, 25% best sites.



Figuer 6-50 MV and HV sites, "MANY" scope (3 voltage channels recorded), type II and (3A) shape at the same time, 25% best sites.

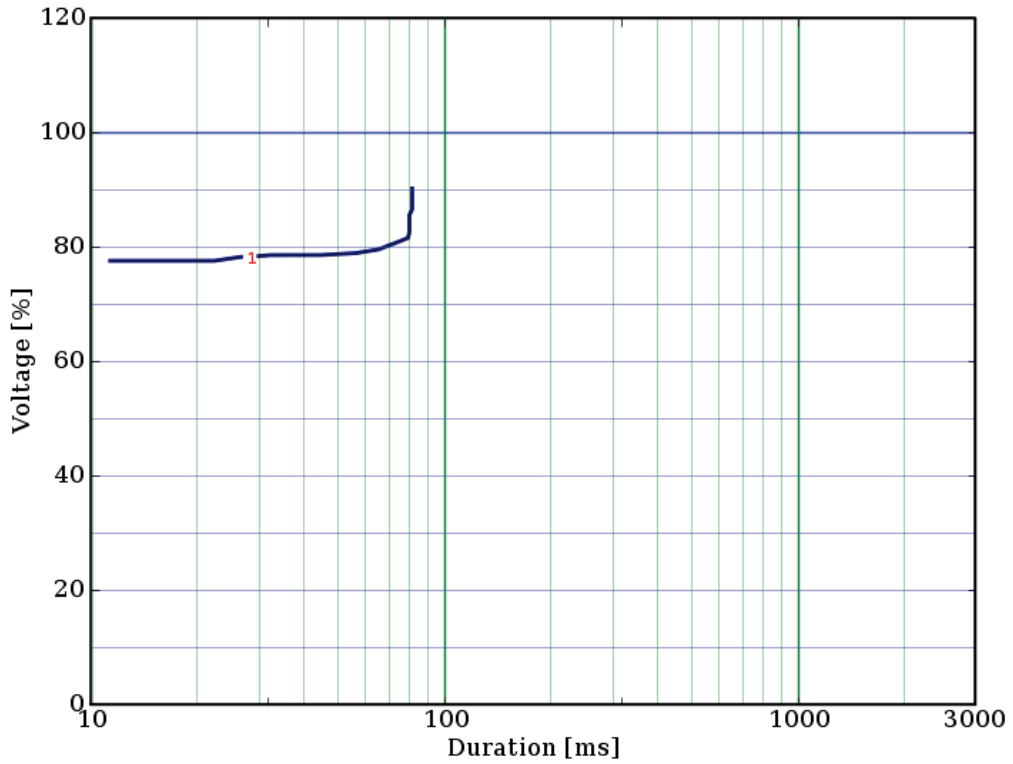

Figure 6-51 MV and HV sites, "MANY" scope (3 voltage channels recorded), type II and (3B) shape at the same time, 25% best sites.

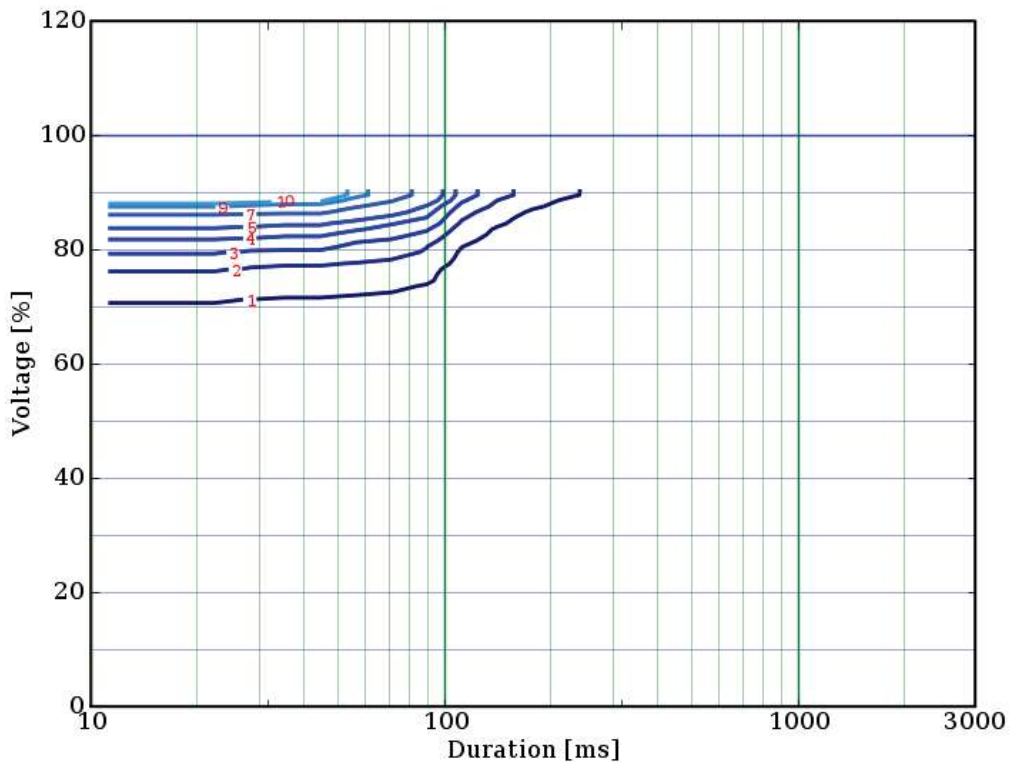

Figure 6-52 MV and HV sites, "MANY" scope (3 voltage channels recorded), type II and (3C) shape at the same time, 25% best sites.

6.6 Low voltage sites

It should be kept in mind that the records in for the low-voltage sites are taken mostly at MV/LV stations, thus not including (the impact of) the LV electric distribution network present in many countries. Moreover, it is more representative of domestic than industrial sectors.

These LV charts cannot be compared with the HV and MV charts since generally they correspond to different geographical regions.

As well as the “MANY” scope already applied on MV and HV data, a broader scope “ALL” has been used. This scope corresponds to all the LV sites without exception. Therefore, when only the worst channel is recorded, no characterisation of the dip can be carried out.

Furthermore, since phase-to-neutral measurements are employed, no characterisation against IEC test vectors can be done, even for the “MANY” scope.

6.6.1 Contour charts for the LV 95% best sites, “ALL” scope

The contour chart for the 95% site over all LV sites is shown in Figure 6-53. For each voltage-duration point the worst 5% of the sites are disregarded.

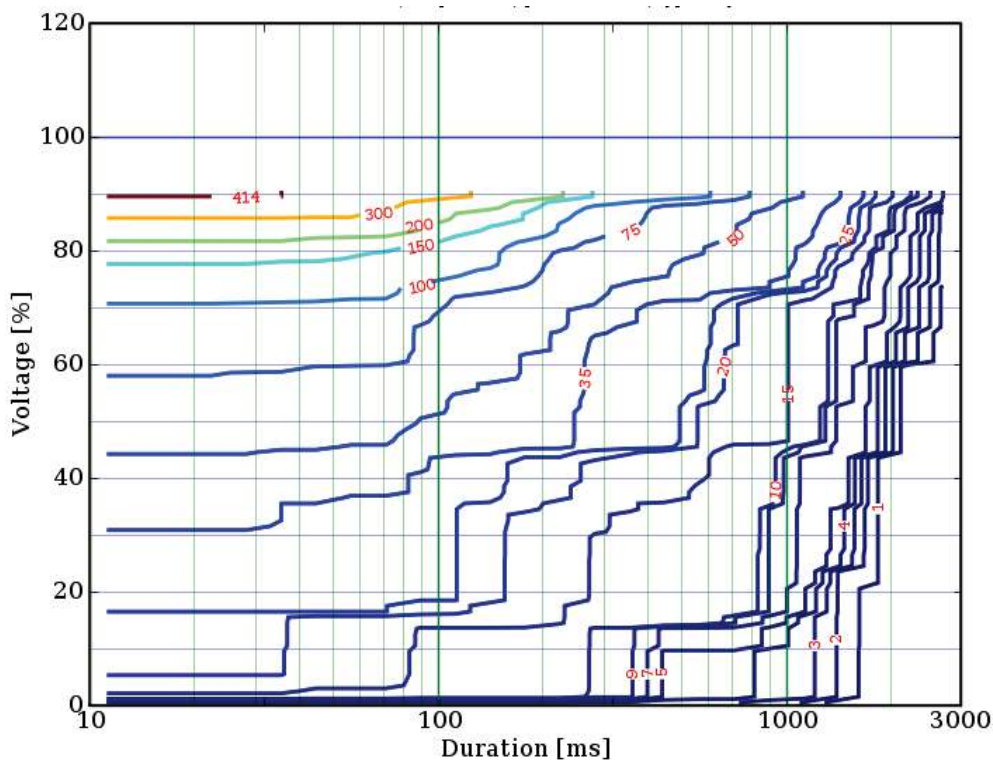

Figure 6-53 LV sites, “ALL” scope (at least worst channel recorded), 95% best sites.

6.6.2 Contour charts for the LV 90% best sites, "ALL" scope

The contour chart for the 90% site over all LV sites is shown in Figure 6-54. For each voltage-duration point the worst 10% of the sites are disregarded.

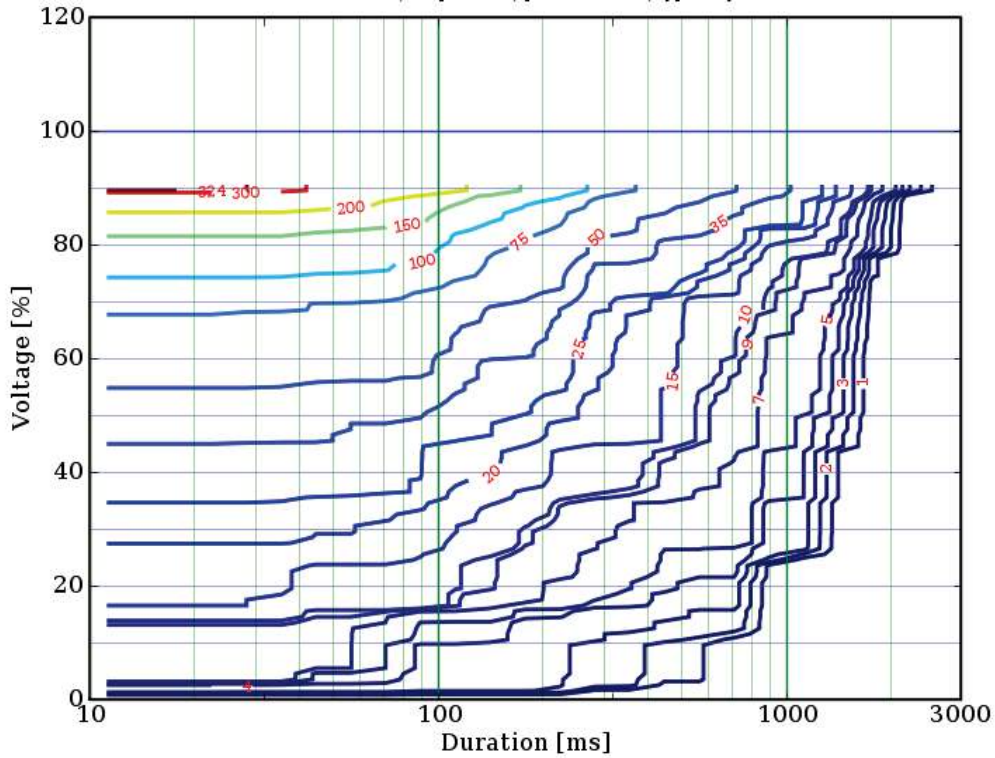

Figure 6-54 LV sites, "ALL" scope (at least worst channel recorded), 90% best sites.

6.6.3 Contour charts for the LV 75% best sites, "ALL" scope

The contour chart for the 75% site over all LV sites is shown in Figure 6-54. For each voltage-duration point the worst 25% of the sites are disregarded.

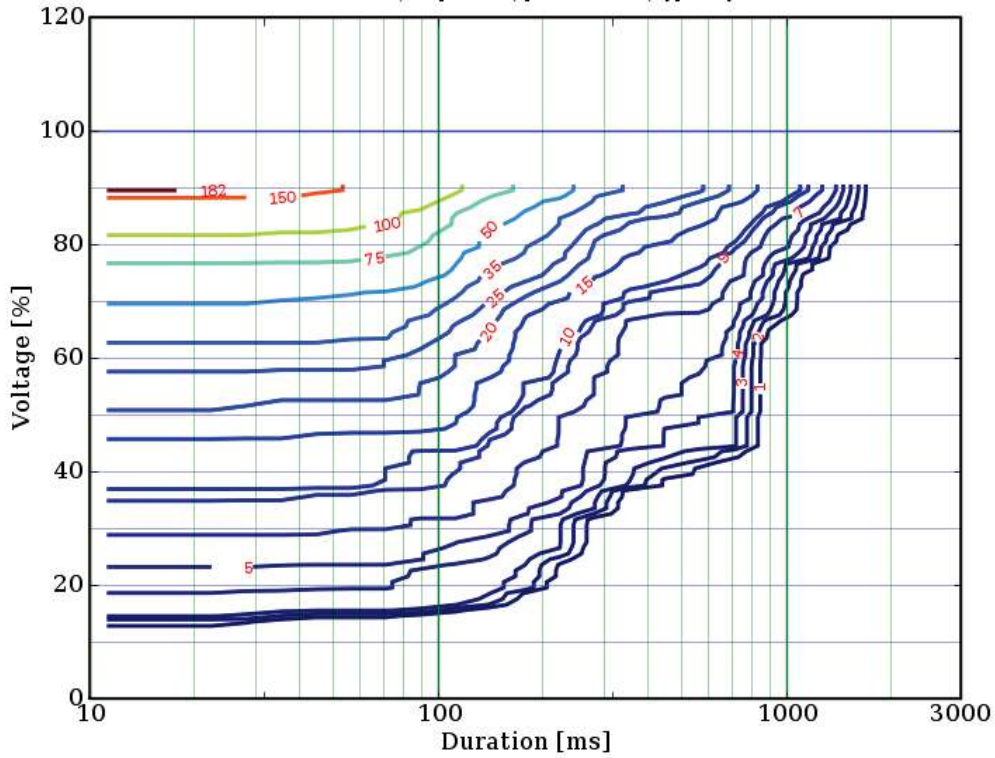

Figure 6-55 LV sites, "ALL" scope (at least worst channel recorded), 75% best sites.

6.6.4 Contour charts for the LV 50% best sites (median value), "ALL" scope

The contour chart for the 50% site over all LV sites is shown in Figure 6-56. For each voltage-duration point the worst 50% of the sites are disregarded.

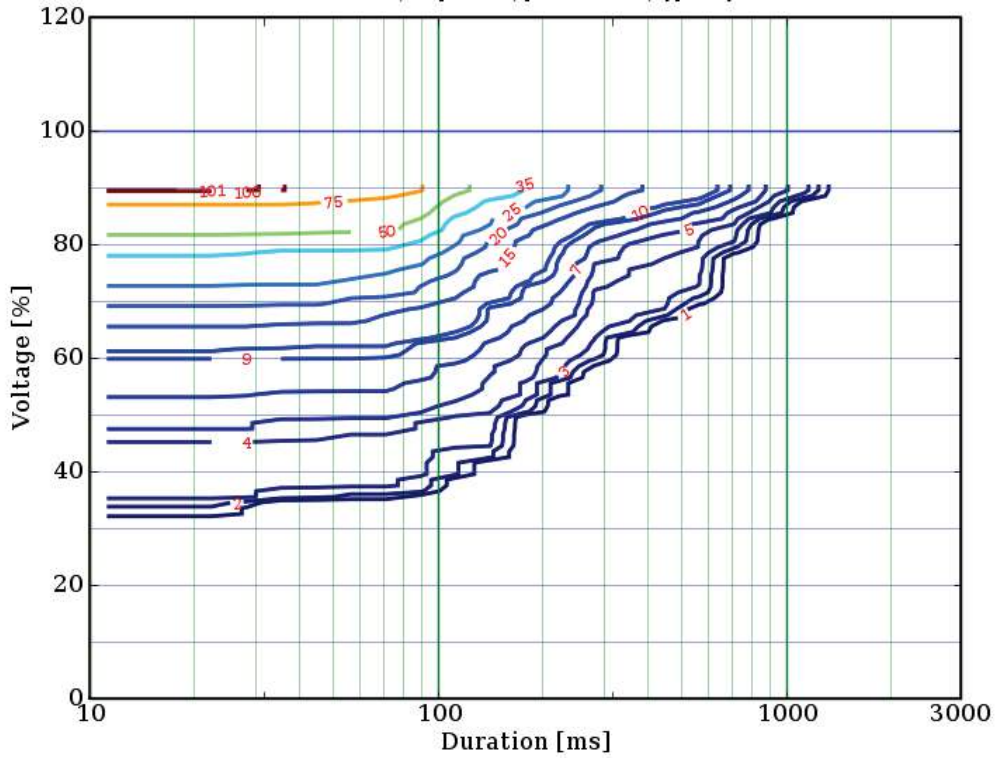

Figure 6-56 LV sites, "ALL" scope (at least worst channel recorded), 50% best sites.

6.6.5 Contour charts for the LV 25% best sites, "ALL" scope

The contour chart for the 25% site over all LV sites is shown in Figure 6-57. For each voltage-duration point the worst 75% of the sites are disregarded.

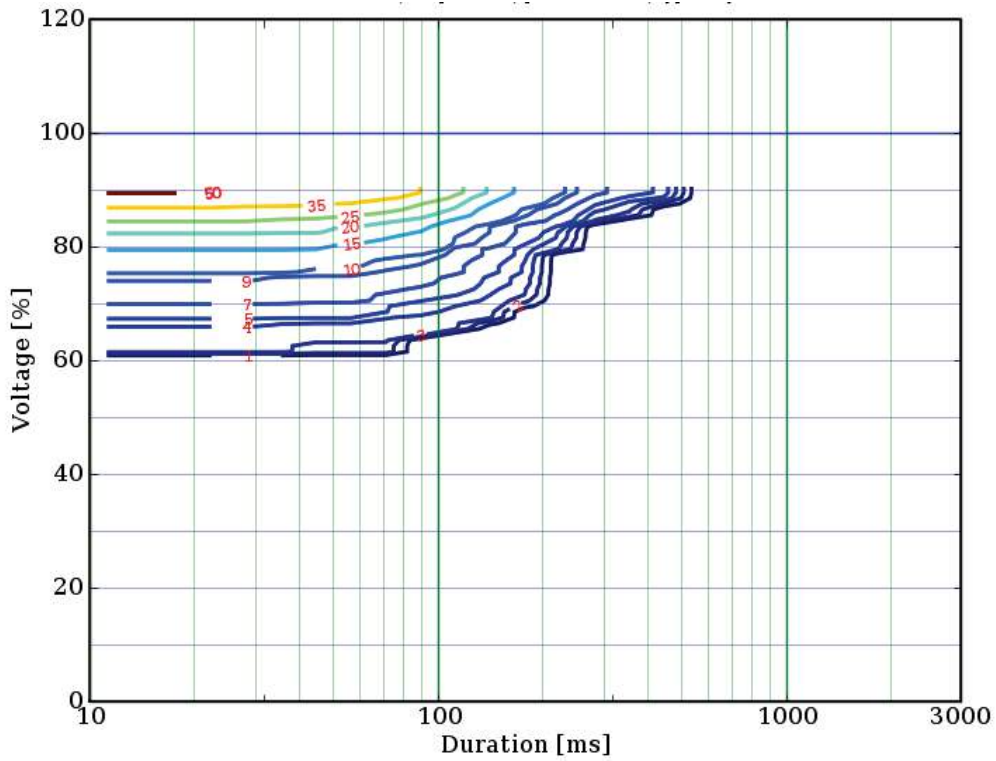

Figure 6-57 LV sites, "ALL" scope (at least worst channel recorded), 25% best sites.

6.6.6 Contour charts for the LV 95% best sites, "MANY" scope

The contour charts for the 95% site over many LV sites are shown in Figure 6-58 through 6-61. Only sites with the three individual voltages available could be used for this. For each voltage-duration point the worst 5% of the sites are disregarded.

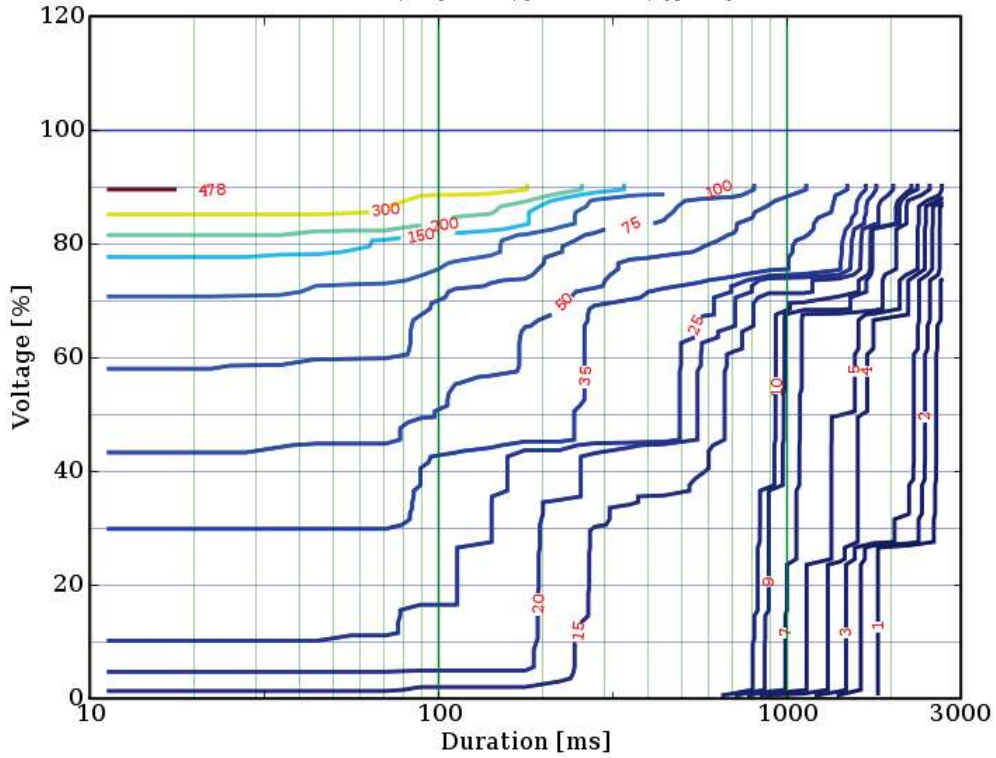

Figure 6-58 LV sites, "MANY" scope (3 voltage channels recorded), 95% best sites.

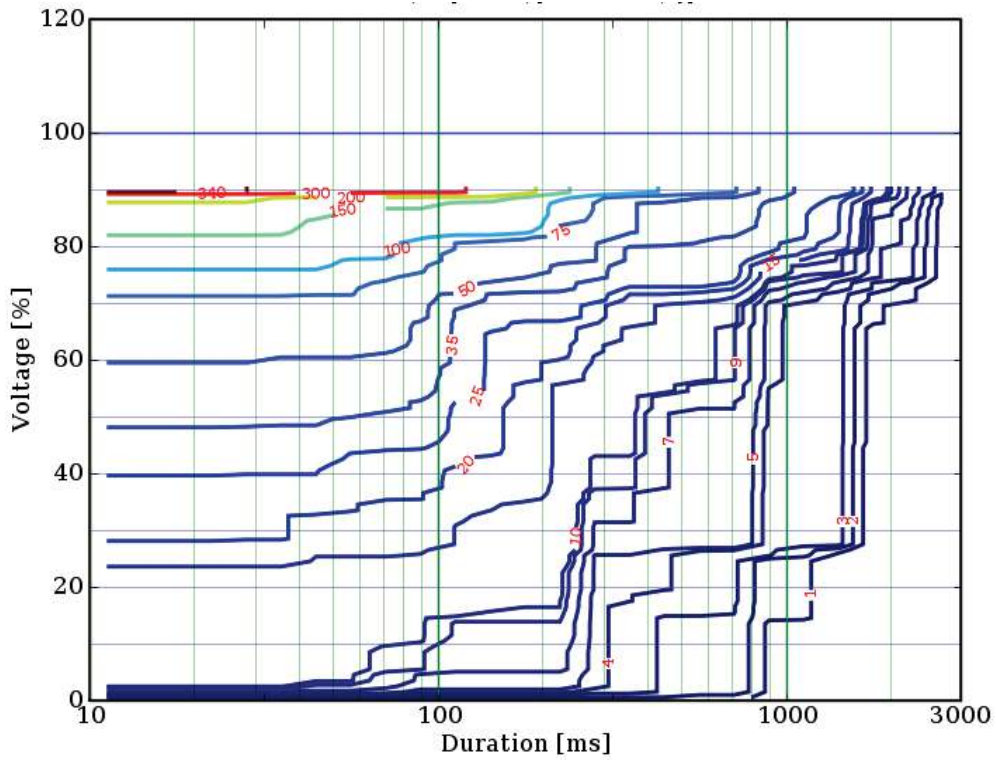

Figure 6-59 LV sites, "MANY" scope (3 voltage channels recorded), only type I dips, 95% best sites.

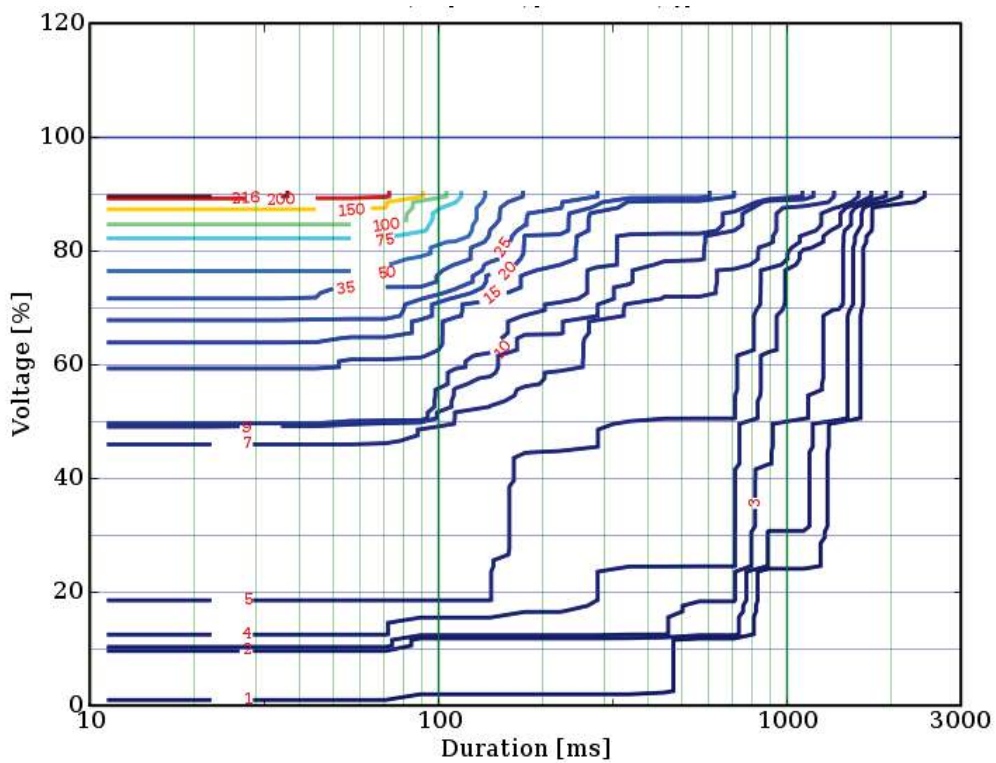

Figure 6-60 LV sites, "MANY" scope (3 voltage channels recorded), only type II dips, 95% best sites.

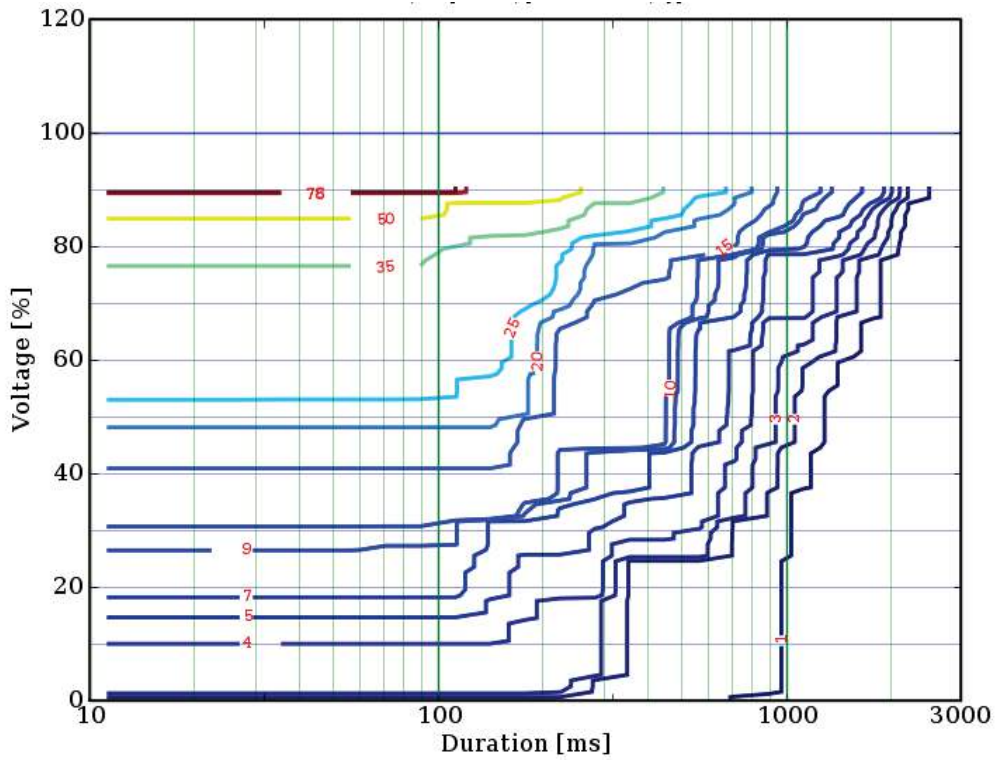

Figure 6-61 LV sites, "MANY" scope (3 voltage channels recorded), only type III dips, 95% best sites.

6.6.7 Contour charts for the LV 90% best sites, "MANY" scope

The contour charts for the 90% site over many LV sites are shown in Figure 6-62 through 6-65. For each voltage-duration point the worst 10% of the sites are disregarded.

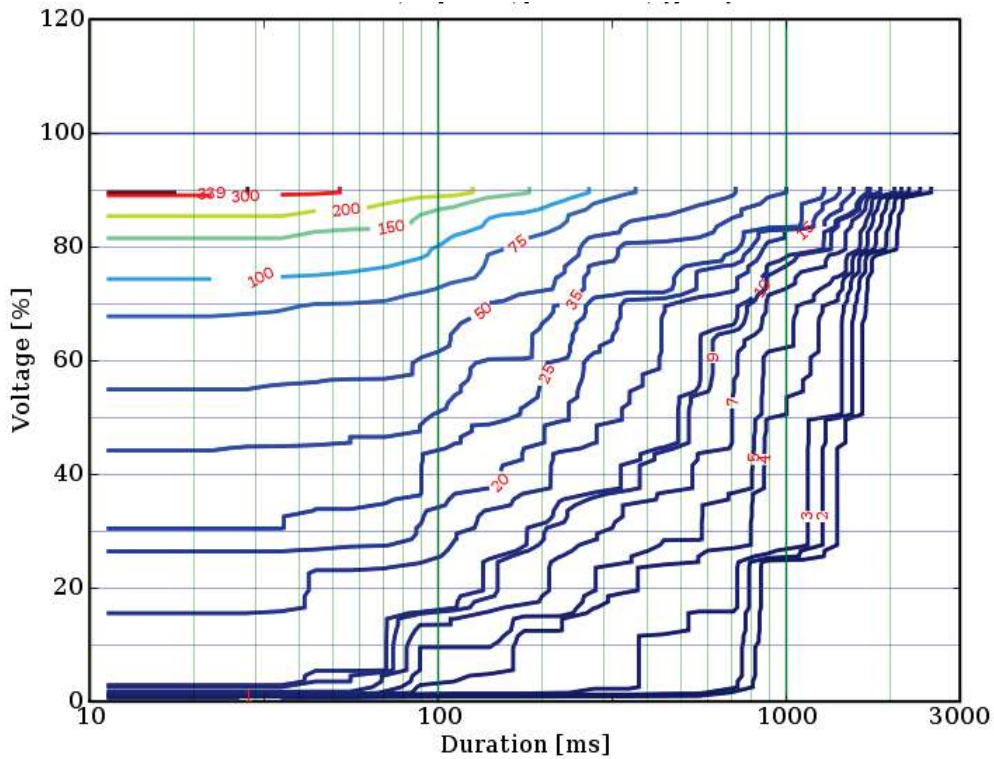

Figure 6-62 LV sites, "MANY" scope (3 voltage channels recorded), 90% best sites.

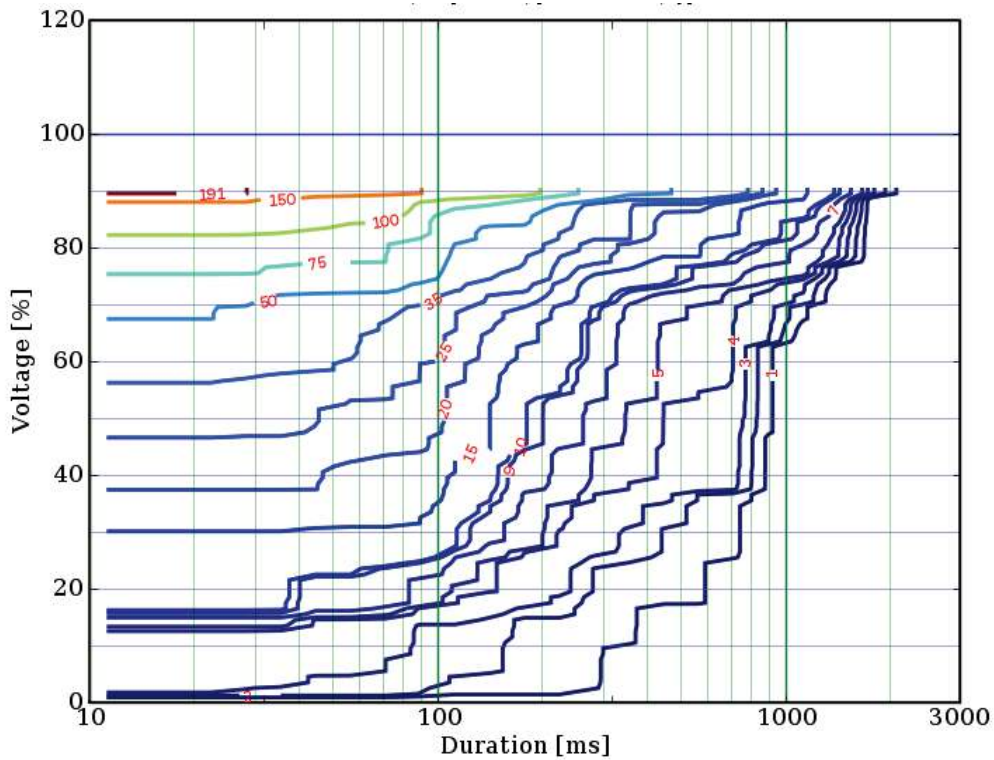

Figure 6-63 LV sites, "MANY" scope (3 voltage channels recorded), only type I dips, 90% best sites.

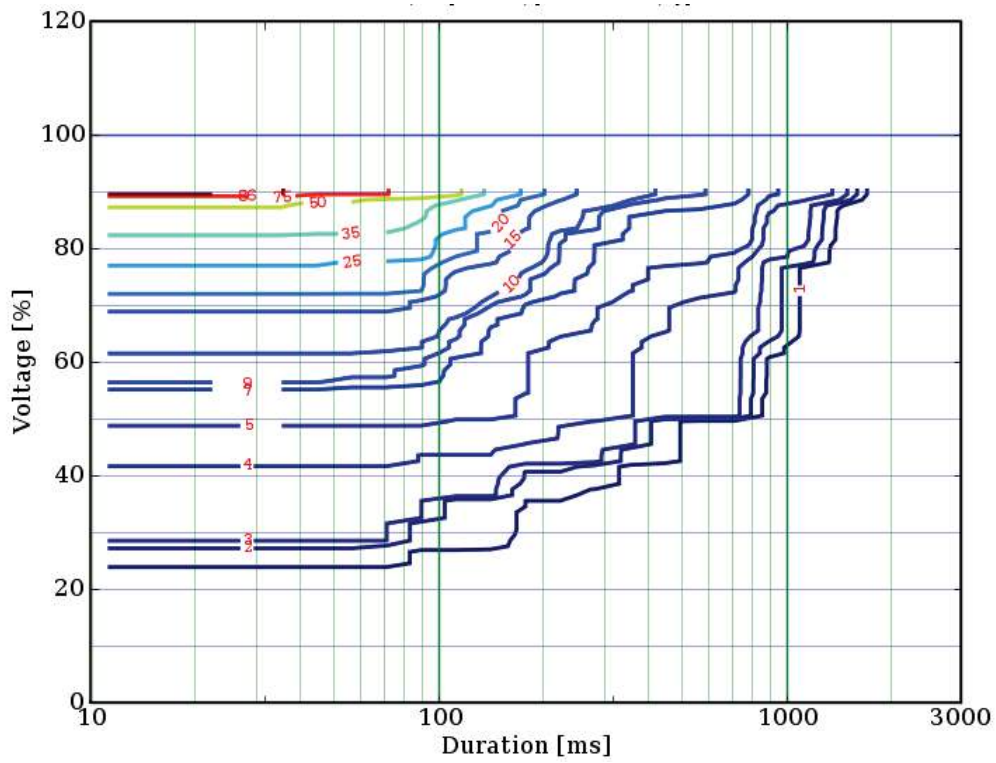

Figure 6-64 LV sites, "MANY" scope (3 voltage channels recorded), only type II dips, 90% best sites.

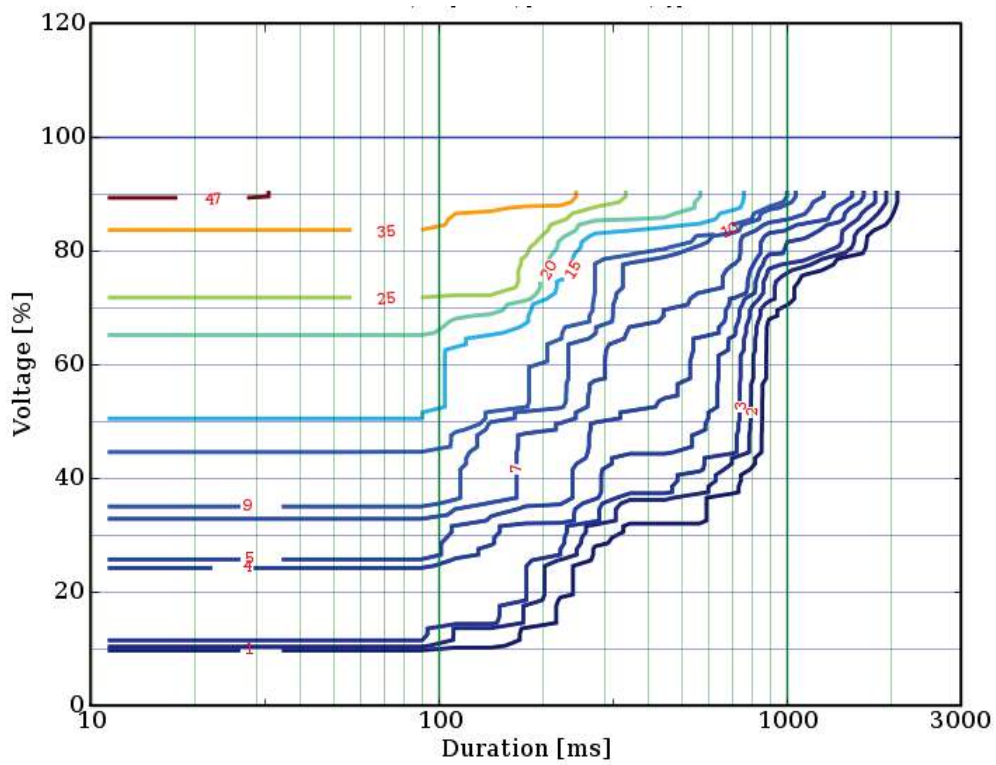

Figure 6-65 LV sites, "MANY" scope (3 voltage channels recorded), only type II dips, 90% best sites.

6.6.8 Contour charts for the LV 75% best sites, "MANY" scope

The contour charts for the 75% site over many LV sites are shown in Figure 6-66 through 6-69. For each voltage-duration point the worst 25% of the sites are disregarded.

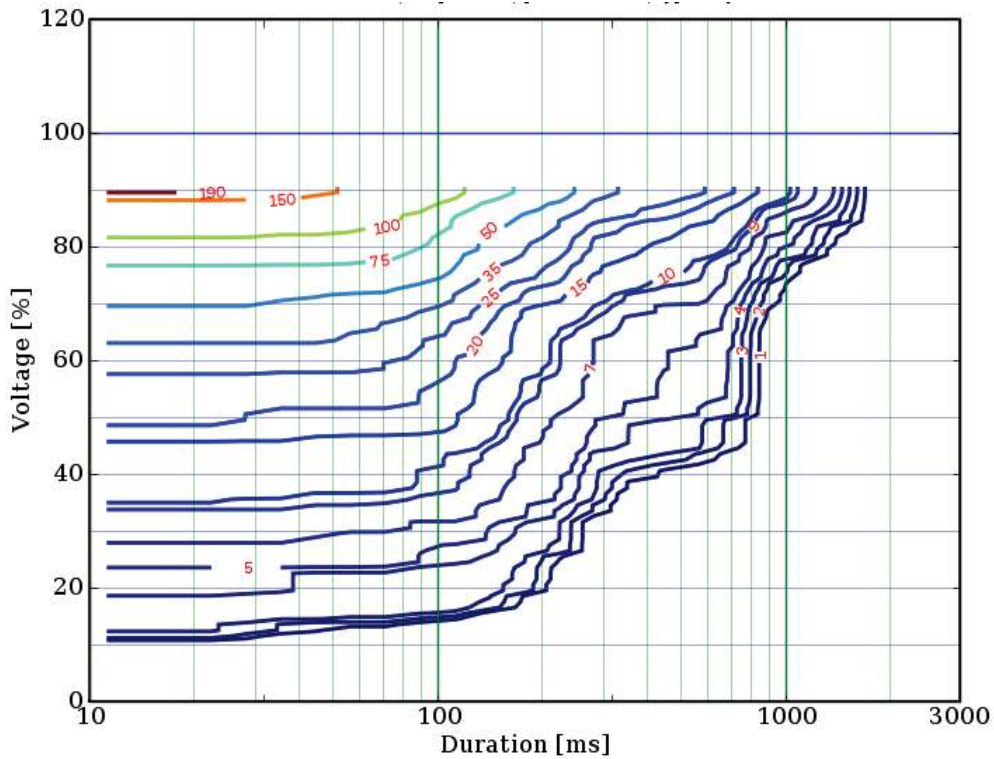

Figure 6-66 LV sites, "MANY" scope (3 voltage channels recorded), 75% best sites.

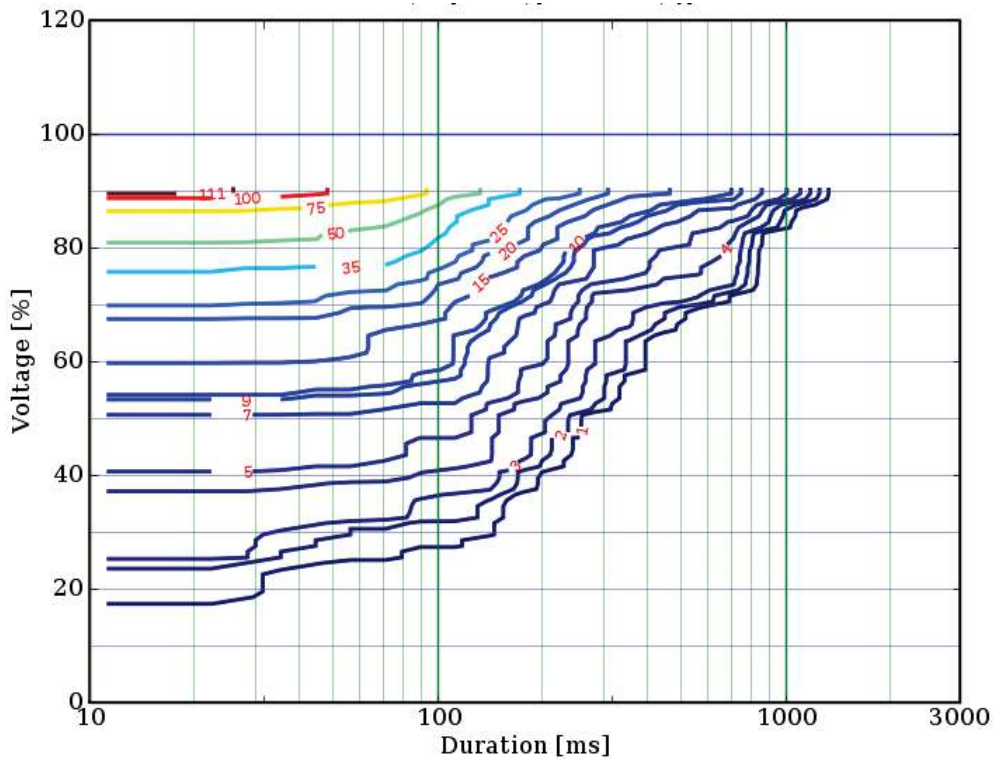

Figure 6-67 LV sites, "MANY" scope (3 voltage channels recorded), only type I dips, 75% best sites.

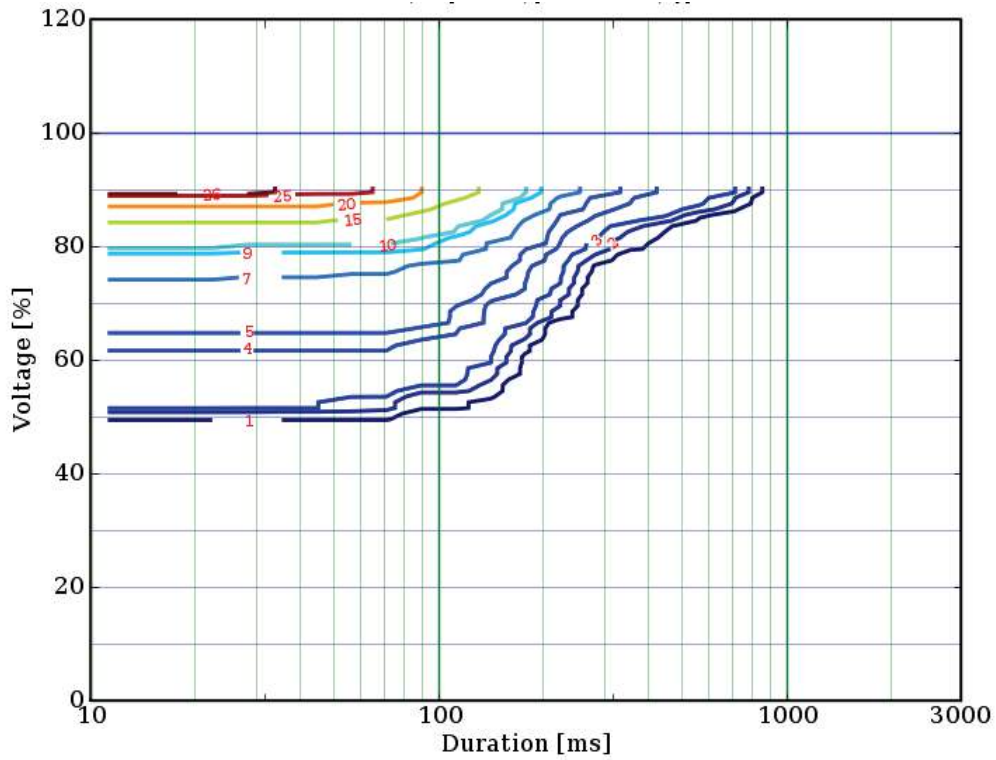

Figure 6-68 LV sites, "MANY" scope (3 voltage channels recorded), only type II dips, 75% best sites.

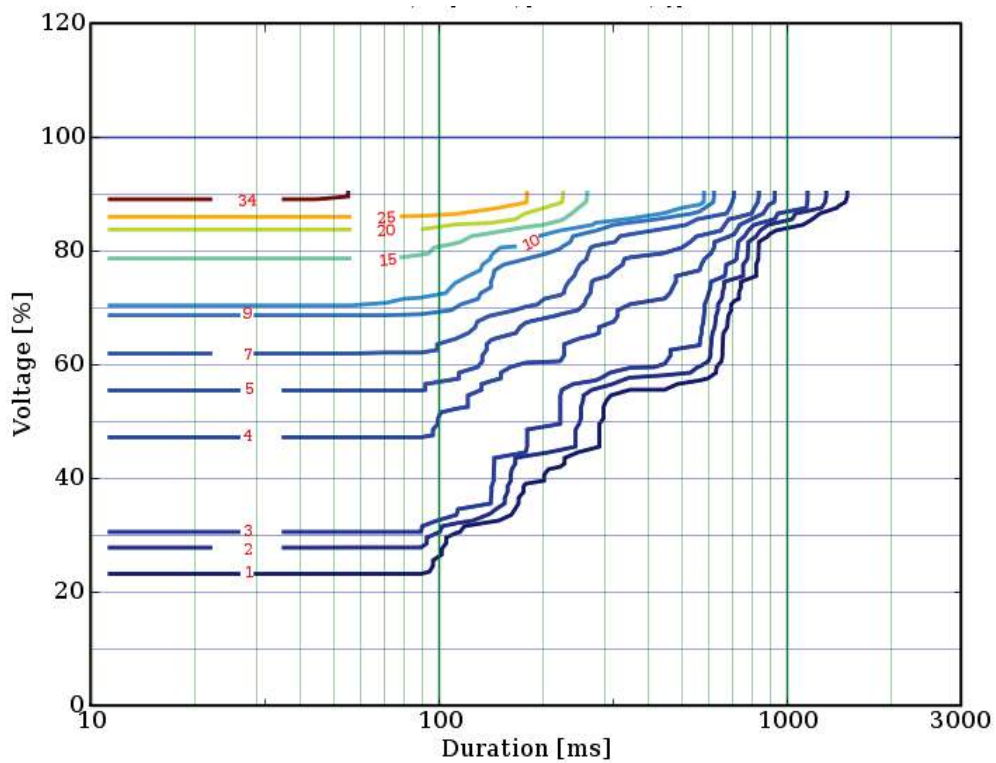

Figure 6-69 LV sites, "MANY" scope (3 voltage channels recorded), only type III dips, 75% best sites.

6.6.9 Contour charts for the LV 50% best sites (median value), "MANY" scope

The contour charts for the 50% site over many LV sites are shown in Figure 6-70 through 6-73. For each voltage-duration point the worst 50% of the sites are disregarded.

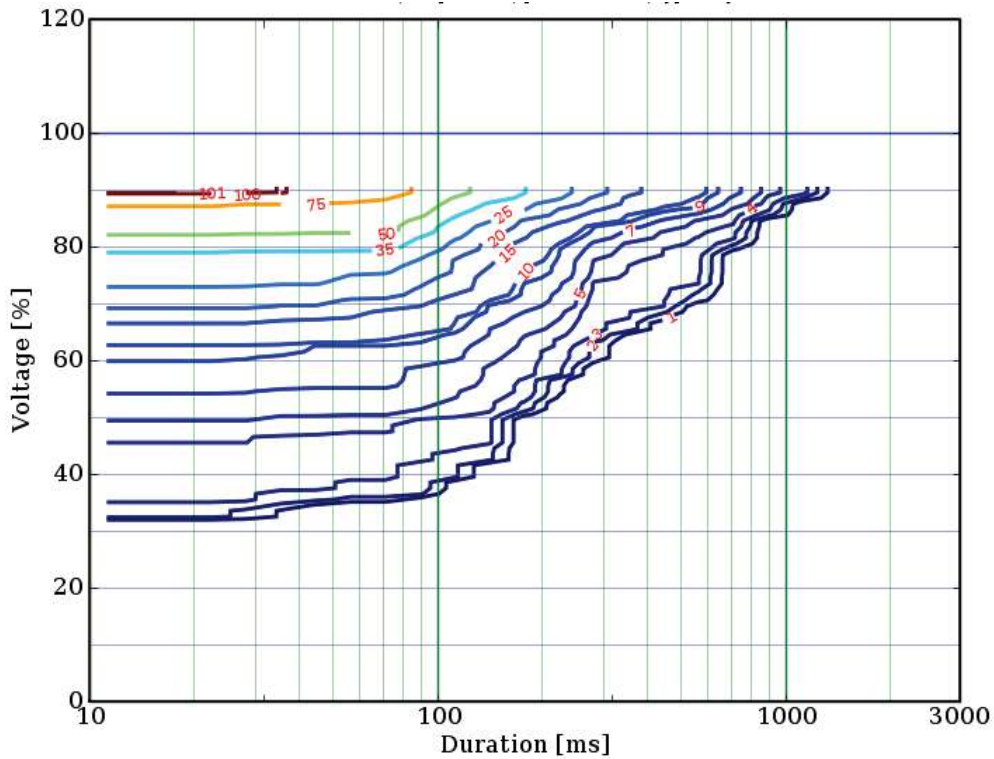

Figure 6-70 LV sites, "MANY" scope (3 voltage channels recorded), 50% best sites.

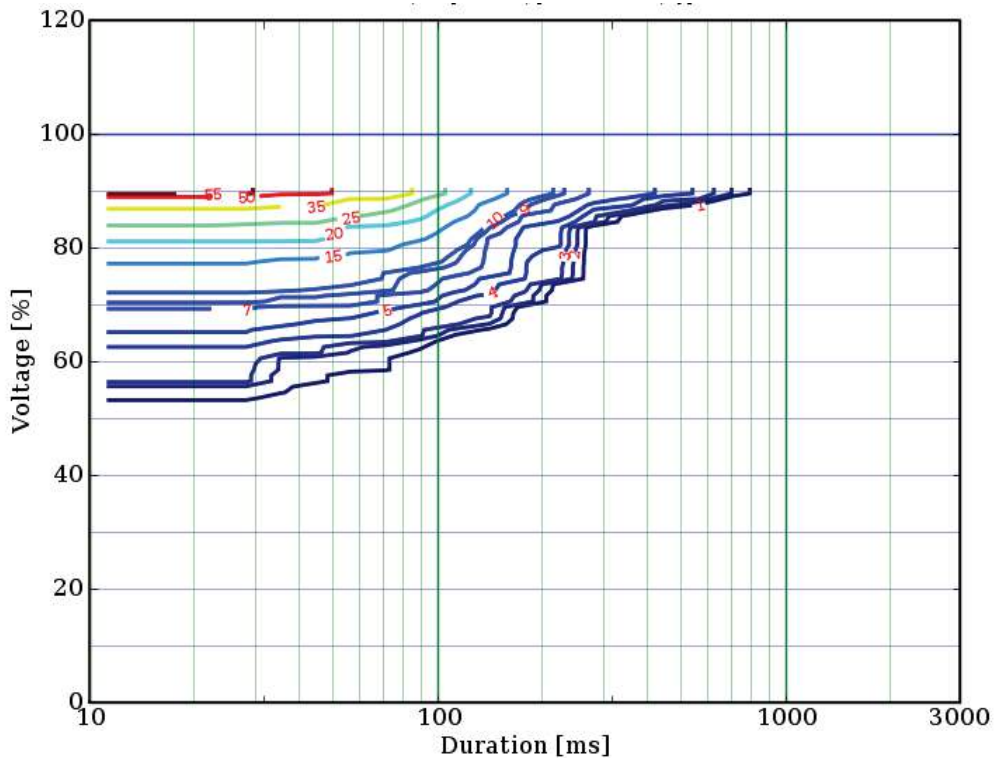

Figure 6-71 LV sites, "MANY" scope (3 voltage channels recorded), only type I dips, 50% best sites.

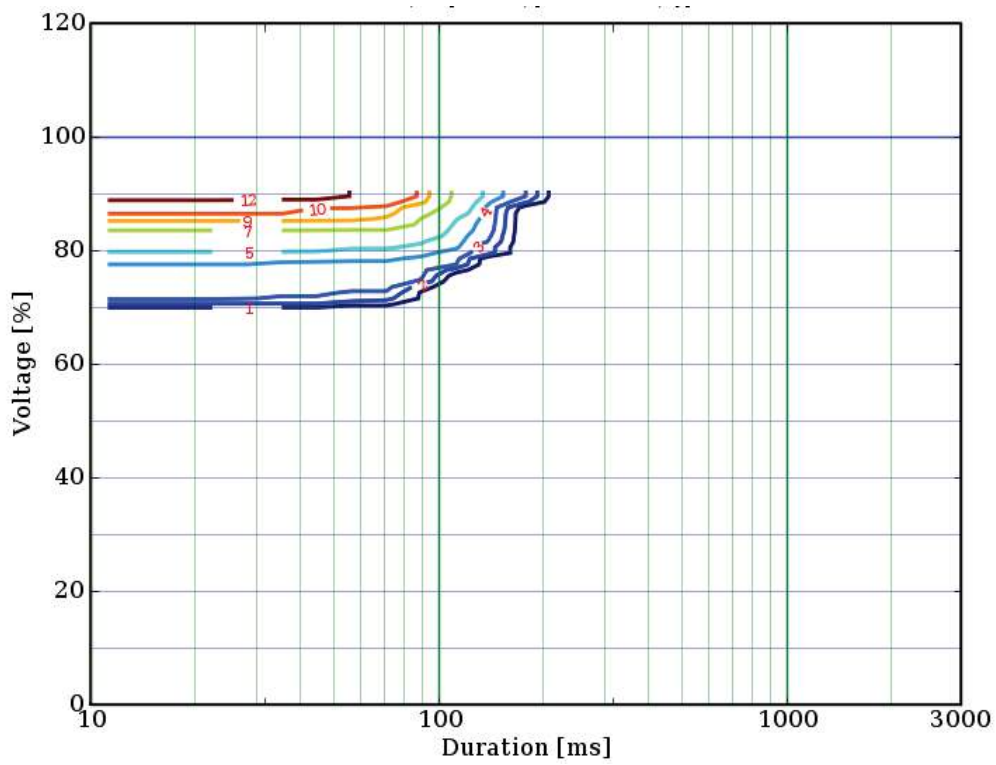

Figure 6-72 LV sites, "MANY" scope (3 voltage channels recorded), only type II dips, 50% best sites.

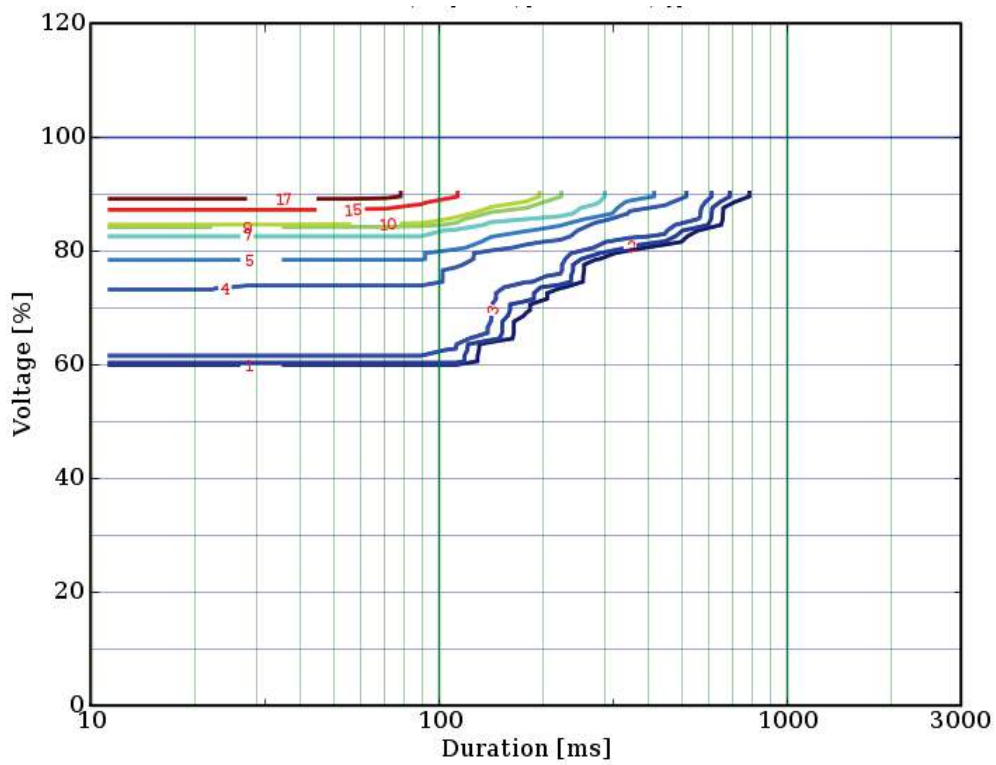

Figure 6-73 LV sites, "MANY" scope (3 voltage channels recorded), only type III dips, 50% best sites.

6.6.10 Contour charts for the LV 25% best sites, "MANY" scope

The contour charts for the 25% site over many LV sites are shown in Figure 6-74 through 6-77. For each voltage-duration point the worst 75% of the sites are disregarded.

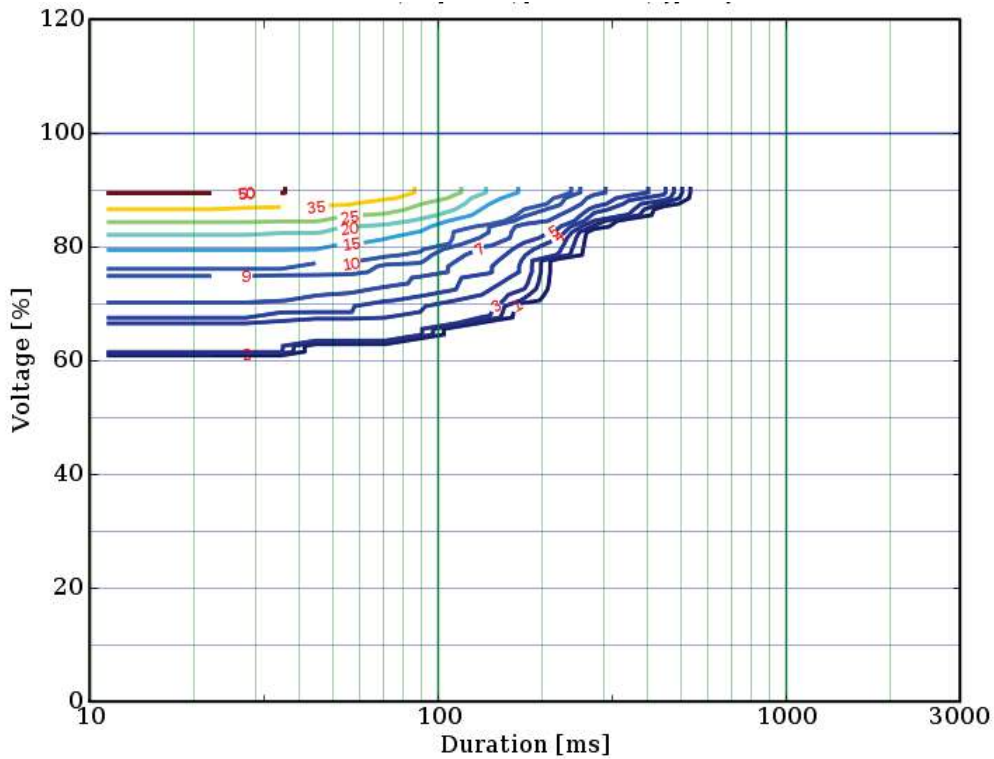

Figure 6-74 LV sites, "MANY" scope (3 voltage channels recorded), 25% best sites.

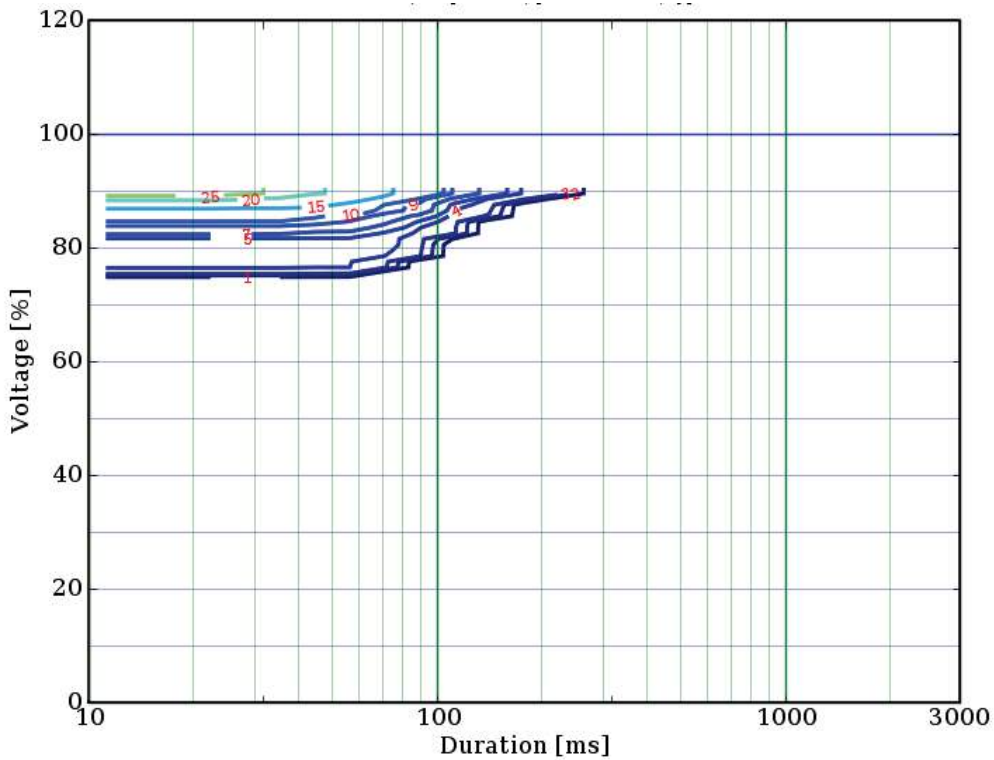

Figure 6-75 LV sites, "MANY" scope (3 voltage channels recorded), only type I dips, 25% best sites.

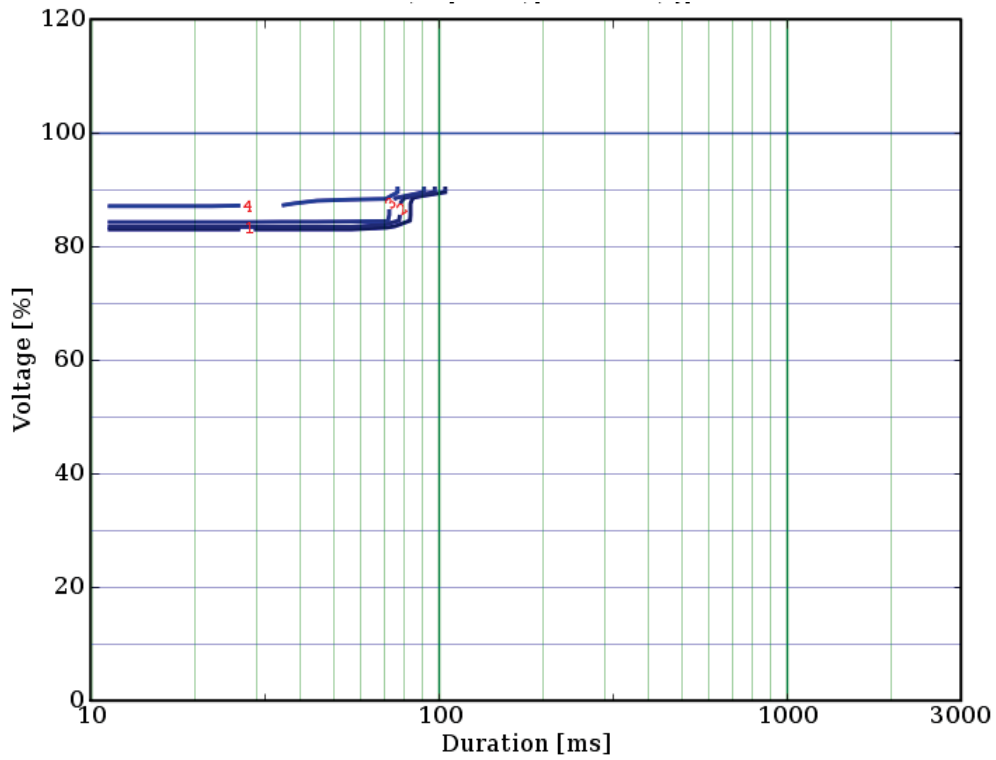

Figure 6-76 LV sites, "MANY" scope (3 voltage channels recorded), only type II dips, 25% best sites.

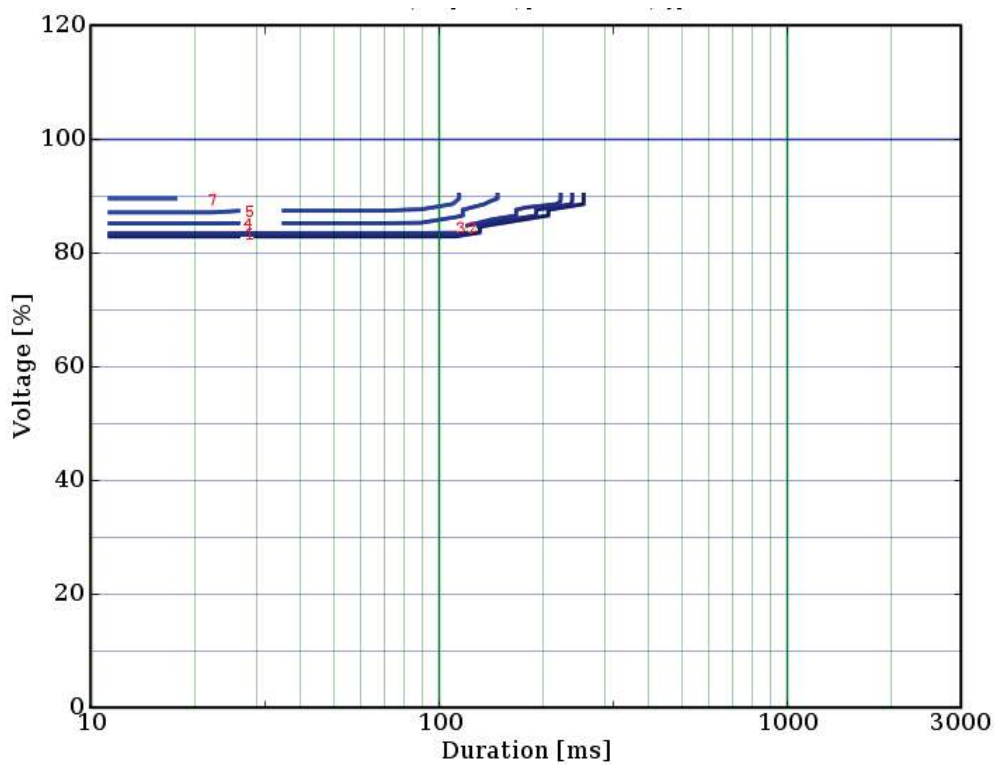

Figure 6-77 LV sites, "MANY" scope (3 voltage channels recorded), only type III dips, 25% best sites.

6.7 Conclusions from the database

Just counting the number of dips, without any percentile classification, an overall view of type I, II and III dips is obtained, as shown in Table 6-5.

Networks \ Type	I	II	III
MV and HV	27%	53%	20%
LV	64%	25%	11%

Table 6-5 Overall distribution of voltage dips types.

Nevertheless, this distribution does not take into account any percentile (no sites are disregarded).

In Table 6-6 the relative composition of dips is derived by using the highest number of dips per site and year of each chart. Please note that the sum of dips is not automatic, i.e. by adding type I, II and III values we do not get the value correspondent to type "any". However, these values are considered to be quite close (right column).

Networks \ Type	Percentile	I	II	III	any	I	II	III	(I+II+III)/any
MV and HV	95%	83	151	63	270	28%	51%	21%	110%
	90%	53	110	45	192	25%	53%	22%	108%
	75%	28	62	20	116	25%	56%	18%	95%
	50%	13	31	9	61	25%	58%	17%	87%
	25%	5	15	4	33	21%	63%	17%	73%
LV	95%	340	216	78	478	54%	34%	12%	133%
	90%	191	86	47	339	59%	27%	15%	96%
	75%	111	26	34	190	65%	15%	20%	90%
	50%	55	12	17	101	65%	14%	20%	83%
	25%	25	4	7	50	69%	11%	19%	72%

Table 6-6 Distribution of voltage dips types according to voltage level and percentiles.

As it can be noticed from the table, type III dips tend to be ~20%, both for LV and above. The volume of Type I at LV seems equivalent to type II at MV and HV. The same relationship seems to apply to type II at LV and type I at MV and above.

Regarding how the IEC models fit practical experience, an extended table, shown in Table 6-7, has been produced.

Networks \ Type	Percentile	I(3A)	I(3B)	I(3C)	II(3A)	II(3B)	II(3C)	III	I(3A+3B+3C)/I	II(3A+3B+3C)/II
HV and MV	95%	70	12	0	0	27	125	63	99%	101%
	90%	41	7	0	0	10	91	45	91%	92%
	75%	21	3	0	0	8	50	20	86%	94%
	50%	9	1	0	0	3	25	9	77%	90%
	25%	3	0	0	0	1	10	4	60%	73%

Table 6-7 Distribution of voltage dip types according to IEC shapes.

It seems that 3C is a good fit for type II dips, while 3A is better aligned to type I dips. Altogether, it can be said that the IEC tests are a reasonably approximation of dips experienced by equipment.

These findings are considered further in Chapter 8 on decisions on dip types to include during testing.

6.8 Considerations about rectangular dips

Throughout the text it has been assumed that voltage dips are mostly rectangular. In fact, this is not always true. Nevertheless, some statistics are shown below that supports this approximation in most situations.

Voltage dip records from ENDESA have a value of minimum voltage during the dip, as well as it's the average voltage. These values are obtained from each measurement channel. For rectangular dips minimum and average voltage are equal. Thus, for all the events supplied by ENDESA the ratio between both magnitudes, as well as the distribution of dips for each tuple (avg-min) voltage is utilised. The results are shown in Table 6-8.

Min / Avg	Dips	Share [%]
0.95-1.00	24743	77%
0.85-0.95	31579	10%
0.75-0.85	11248	3%
0.65-0.75	8191	3%
0.55-0.65	5973	2%
0.25-0.35	5331	2%
0.45-0.55	4294	1%
0.35-0.45	4173	1%
0.15-0.25	2855	1%
0.05-0.15	413	0%

Table 6-8 Distribution of voltage dips according to their ration of minimum and average voltage.

This table indicates that more that most of the dips have a similar minimum and average voltage profile. Almost the same conclusion can be obtained by gathering dips by minimum and average voltage pairs, as shown in Table 6-9.

An extended 2D density chart, covering the same data, is shown in Figure 6-78.

From the tables and the figures, the conclusion is drawn that the rectangular approximation is reasonably accurate for most dip events.

Min [%]	Avg [%]	Dips	Share [%]
85-90	85-90	194020	56%
75-85	75-85	32496	9%
75-85	85-90	20198	6%
0-5	0-5	17394	5%
5-15	5-15	14369	4%
65-75	75-85	10430	3%
65-75	65-75	6982	2%
55-65	65-75	6011	2%
45-55	55-65	3630	1%
5-15	35-45	3118	1%
45-55	65-75	3024	1%
35-45	55-65	2882	1%
55-65	55-65	2250	1%
25-35	45-55	2151	1%
5-15	15-25	2127	1%
5-15	25-35	1854	1%
35-45	45-55	1794	1%
15-25	45-55	1770	1%
55-65	75-85	1719	0%
15-25	35-45	1629	0%
0-5	5-15	1325	0%
25-35	55-65	1174	0%

Table 6-9 Distribution of voltage dips according to their minimum and average voltage.

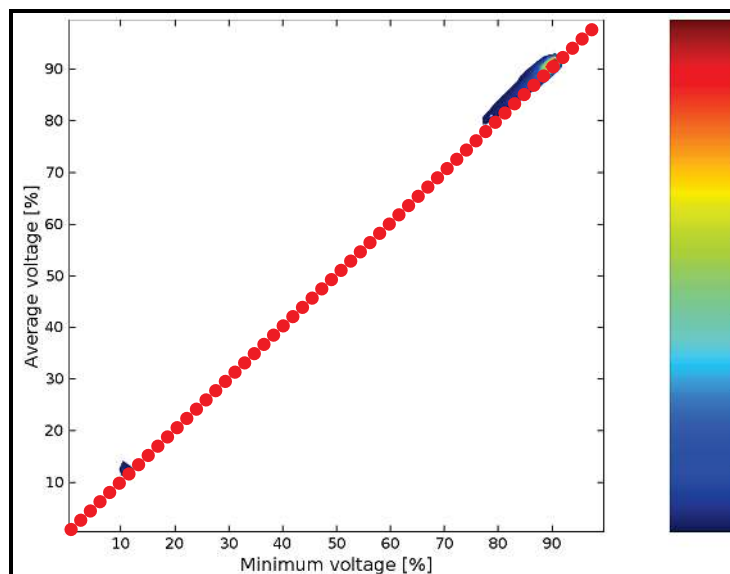

Figure 6-78 Density chart for average-minimum points.

6.9 References

- [1] M.H.J. Bollen, I.Y.H. Gu, Signal processing of power quality disturbances, Wiley – IEEE Press, 2006.
- [2] IEC 61000-4-34:2005.

- [3] IEEE 493:2007 Recommended Practice for the Design of Reliable Industrial and Commercial Power Systems, 7.9 Development of voltage sag coordination charts.
- [4] Power Quality in Japanese Distribution Networks, Electric Technology Research Report, Vol.60, No.2
- [5] L.E. Conrad, M.H.J. Bollen, Voltage sag coordination for reliable plant operation, IEEE Transactions on Industry Applications, Vol.33, no.6, Nov. 1997, pp.1459-1464.

7 Voltage Dip Immunity Classes and Applications

7.1 Introduction

This chapter introduces voltage dip immunity labels, intended to facilitate the communication and exchange of information about equipment dip immunity between equipment manufacturers and equipment end-users. The proposed labels are based on available dip statistics (see Chapter 6), and are one of many possible ways for quantifying or specifying equipment dip immunity. Together with the corresponding testing procedure (Chapter 4, Section 7.2.7 and Appendix 7.D), dip immunity labels allow equipment manufacturers to report dip immunity of their equipment using only a few key test points, as an alternative to detailed performance tests.

Many end-users¹ lack a transparent information on dip immunity of equipment or systems they would like to use or install. Similarly, many equipment manufacturers find it difficult to communicate information about the level of voltage dip immunity of their equipment. With the optimisation of production processes all over the world, it is becoming more important to go beyond the traditional equipment specification on voltage dip tolerance. Chapter 6 demonstrated that voltage dips are, by far, the most frequent disturbance in many end-users environments. Nevertheless, many end-users have difficulties in addressing the issue of voltage dip immunity based on the information currently provided by electricity network operators and equipment manufacturers. This chapter, therefore, provides general guidance on specifying dip immunity of equipment or systems.

The primary objective of this chapter is to provide end-users and plant designers with advice on what steps to take to ensure that their process is not adversely affected by voltage dips. The chapter starts with a description of proposed voltage dip immunity classes, followed by the recommendations on the improvement of process immunity to voltage dips. This is a complex task, as immunity of equipment and processes to voltage dips differs significantly between different end-users. Furthermore, the consequences of process disruption will also vary in a wide range between different end-users. Although the greatest economic consequences may be found among the large industrial users (and discussion in this chapter is mainly directed towards these end-users), the presented methodology can be also applied for smaller industrial end-users, as well as for residential and commercial end-users where appropriate.

A further objective of this report is to provide equipment manufacturers with guidelines on the application of equipment dip immunity tests, and what needs to be considered during the development of equipment with improved dip immunity. A full “check-list” of relevant dip characteristics is available in Section 2.10, while Chapter 4 provides further discussion.

In order to reach above mentioned objectives, it is necessary to consider the responsibilities and give guidance on the roles of involved stakeholders. The three main stakeholders are:

- End-users and process system designers
- Electrical utilities
- Equipment manufacturers

¹ In this document, term “end-users” refers to industrial, commercial and residential end-users.

In most countries, there are no regulatory controls limiting the exposure of end-users to voltage dips. Furthermore, most end-users do not have specific technical knowledge (nor the time or resources to gather it) to make their equipment/process more immune to voltage dips. In many industries, the end-users are neither strong enough nor organised enough to persuade their equipment suppliers to develop equipment with the improved or required voltage dip immunity performance. In some cases, end-users may be able to negotiate private contracts regarding electricity supply power quality, or negotiate equipment specifications with manufacturers, but both of these arrangements are relatively uncommon. In most cases, end-users deal with process disruptions caused by voltage dips by themselves.

Section 7.2 introduces the tools required for the specification of equipment dip immunity, which are then used in Section 7.3 as a part of a general procedure for the assessment of equipment/process dip immunity. The corresponding description of equipment dip performance characteristics is proposed in the form of new ride-through curves for voltage dips, termed “voltage dip immunity labels”. The presented methodology acknowledges that different end-users usually have different costs associated with dip-related process disruptions, and that end-users at different locations will experience different voltage dip frequency and severity. As a consequence, different end-users will have different requirements for equipment dip immunity: usually, the highest requirements will be set by end-users experiencing high costs at locations with a high number of dips, while the lowest requirements will be set by end-users experiencing low costs and low number of dips. To properly reflect this, five different equipment dip immunity classes are proposed. Although the number of immunity classes is generally an arbitrary choice, it is selected here as a reasonable compromise necessary to provide different end-users with sufficient choice, limiting, at the same time, the burden placed on equipment manufacturers.

As discussed in Chapter 3, for some processes it is possible that one or more pieces of equipment trip and recover without causing the disruption of the whole process. In such cases, the corresponding cost of equipment trip is minimal, and end-users can probably accept lower level of dip immunity for this equipment. Therefore, different performance criteria of equipment should be included as a part of general equipment dip immunity specification. These are described in Section 7.2.4.

Section 7.2.7 and Appendix 7.D provide guidance on testing equipment and required documentation for equipment manufacturers.

Section 7.3 considers how end-users can make optimal specification/selection of dip immunity for their equipment when planning/designing new processes, or adapting/improving the existing ones. Regardless of the target application, it is important to make economically balanced dip immunity choices, since over-specified equipment may increase equipment costs dramatically.

7.2 Classification of equipment dip immunity and equipment behaviour: Voltage dip immunity labels

When end-users need to select voltage dip immunity for their equipment, two fundamental questions should be answered:

1. What degree/level of equipment dip immunity is required?
2. What is the required behaviour of equipment during and after a voltage dip?

Section 7.2.1, Classification of equipment dip immunity, provides possible answers to the first question, by introducing equipment dip immunity classes and associated voltage-tolerance curves. Section 7.2.4, Equipment performance criteria, introduces the possible choices to answer the second question.

Section 7.2.5, Voltage dip immunity labels, combines equipment dip immunity classes and equipment performance criteria into “voltage dip immunity labels”, to allow easier communication of information on equipment dip performance between end-users and manufacturers. Section 7.3 considers the selection of the appropriate voltage dip immunity label(s).

7.2.1 Classification of equipment dip immunity

There are many types of voltage dips, and no one is exactly equal to any other. However, as shown previously in Chapters 2 and 6, there are patterns which make it possible to classify dip events. Accordingly, the five equipment dip immunity classes described below are proposed with respect to three general types of voltage dips.

Equipment dip immunity Class A: Specifies the highest level of equipment immunity to voltage dips, including immunity to short interruptions with the duration of up to 1 second for dip Types I and II, and up to 200 ms for dip Type III.

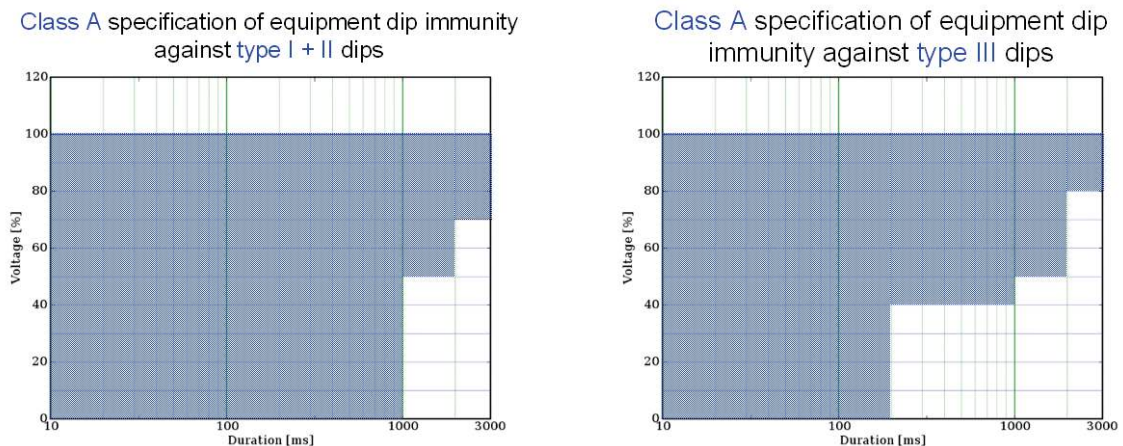

Figure 7-1 Voltage-tolerance curves for Class A specification of equipment dip immunity.

Equipment dip immunity Class B: Specifies a good level of equipment immunity to most voltage dips.

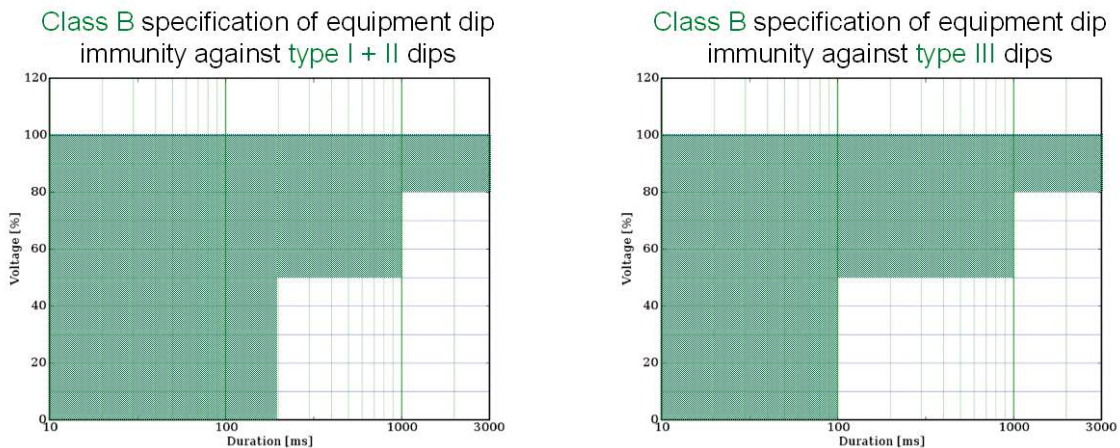

Figure 7-2 Voltage-tolerance curves for Class B specification of equipment dip immunity.

Equipment dip immunity Class C1: Provides a reasonable level of equipment immunity to many voltage dips. This class is based on the requirements for unbalanced dips (i.e. dip Types I and II) in IEC 61000-4-11/34, [1-2], while new specification is proposed for balanced dips (i.e. Type III dips). According to some of Working Group members, equipment designed to comply with only IEC 61000-4-11/34 requirements is not likely to comply with this dip immunity class.

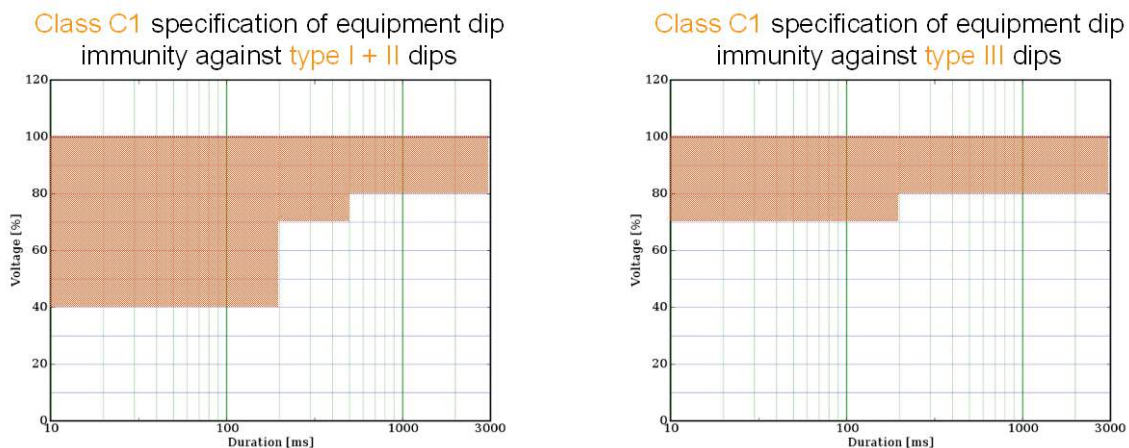

Figure 7-3 Voltage-tolerance curves for Class C1 specification of equipment dip immunity.

Equipment dip immunity Class C2: Provides level of equipment dip immunity similar to class C1. However, there is a slight difference in specification for Type I and II dips, in order to take into account certain nominal voltage levels which are typical in many countries. This class is based on the requirements for Types I and II dips in SEMI F47-0706, [3], while new specification is introduced for balanced/Type III dips (similarly to class C1). As in the previous case, equipment designed to comply with only SEMI F47-0706 requirements is not likely to comply with this dip immunity class.

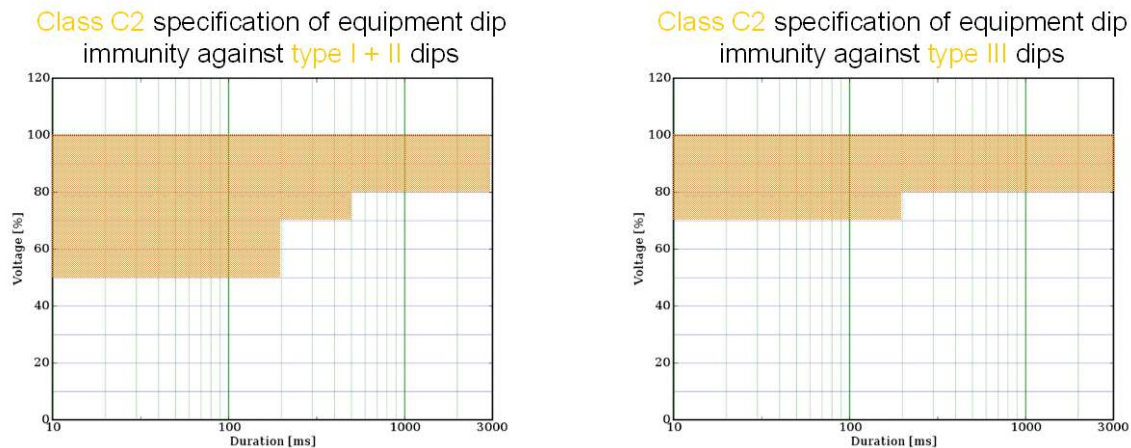

Figure 7-4 Voltage-tolerance curves for Class C2 specification of equipment dip immunity.

Equipment dip immunity Class D: Provides a basic level of equipment dip immunity.

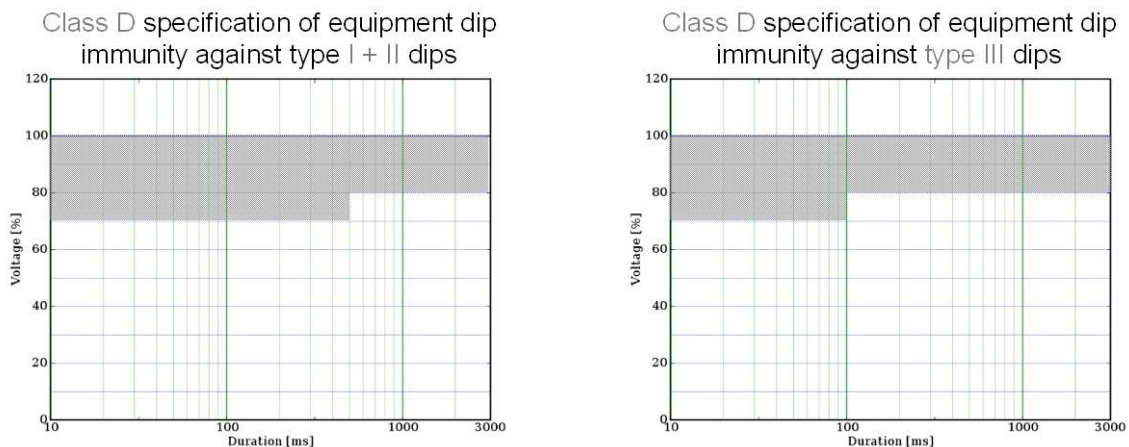

Figure 7-5 Voltage-tolerance curves for Class D specification of equipment dip immunity.

Equipment dip immunity Class E: Denotes equipment immunity that does not fall into any of the other classes.

7.2.2 Discussion on the selection of dip immunity classes

In principle, every end-user can specify arbitrary (e.g. desired or required) level of equipment dip immunity for any particular application under consideration.

The proposed dip immunity classes are aimed to simplify the process of selecting/ordering equipment with required general dip performance, particularly in case of end-users who do not have the time or resources to make their own detailed specifications. They offer a systematic, unified and transparent way of representing different levels of equipment dip immunity, what may help in communicating this information between end-user and equipment manufacturer.

Dip immunity classes introduced in the previous section are proposed as a way to specify/quantify equipment dip immunity (i.e. to make specification of equipment dip immunity easier for end-users), and equipment manufacturers may or may not use them to state the actual level of dip immunity of their equipment. If and when asked by end-users

about the level of dip immunity of their equipment, manufacturers again may or may not use proposed dip classes to answer this question; but if they use them, they can effectively substitute detailed performance tests with a limited number of test points, which should be less expensive.

The proposed dip immunity classes are not in any way part of mandatory requirements for equipment manufacturers. They are chosen using the dip statistics available to the Working Group, and are based on the criteria described in the further text.

Dip immunity classes are ranked from the lowest number of equipment trips to the highest number of equipment trips (starting with the highest immunity class, Class A)

The actual division of classes is the result of an attempt to uniformly distribute the probability of equipment trips between different classes: the difference in the number of equipment trips between any class and the next higher/lower class should be roughly equal.

As mentioned, voltage-tolerance curves for the proposed dip immunity classes are based on available dip statistics. Economic criteria (equipment costs, costs of equipment testing, etc.) were not considered during the selection of voltage-tolerance curves, as this information was not available to Working Group. Further research in this area, however, is strongly encouraged.

The area below voltage-tolerance curves is minimised, as this can reduce equipment costs for some types of equipment for which less energy storage may be required. In the general case, however, the area below the voltage tolerance curve is not directly related to energy storage requirements. Further research is again encouraged, especially because there was no general consensus within the Working Group about equipment dip immunity specifications for Type III dips.

Voltage-tolerance curves for Type III dips were chosen in such a way that the number of Type III dips below the curves is about the same as the number of Type I and Type II dips below the corresponding curves for each class. It should be recognised that this is an arbitrary decision – there is no any particular reason to match the number of dips below voltage-tolerance curves for different types of dips.

Generally, there are many different voltage-tolerance curves that could lead to the same number of equipment trips. Figure 7-6 illustrates an example of two voltage-tolerance curves with the same number of equipment trips.

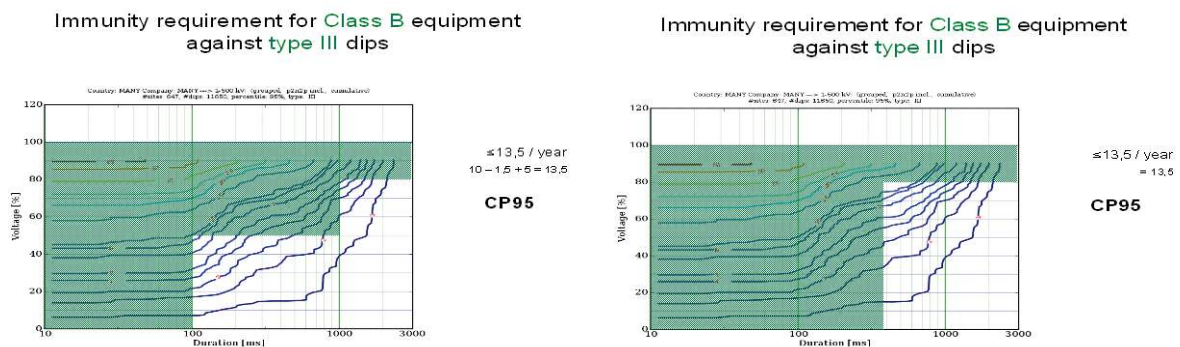

Figure 7-6 Two different voltage-tolerance curves with the same number of equipment trips.

The Working Group members are well aware of the possible limitations of the method used to select voltage-tolerance curves, and recommend further research on other appropriate sets of equipment dip immunity classes. The development of a mathematical model of the economic factors involved in the analysis of equipment dip immunity is particularly encouraged. Such a model could be used as the basis for the identification and collection of the required economic data, since this was one of the reasons for the lack of economic data in this report.

For each equipment dip immunity class, *three-phase equipment* should be tested for all three types of voltage dips (i.e. for Type I, Type II and Type III dips, see Chapter 4). Accordingly, the specification for each class would consist of three voltage-tolerance curves, but for simplicity the curves for Type I and Type II dips proposed here are the same. On the other hand, *single-phase equipment* should be tested only for one dip type: phase-to-neutral connected equipment against Type I dips, and phase-to-phase connected equipment against Type II dips.

Mandatory requirements for testing equipment dip immunity (e.g. [1-2]) do not consider Type III dips, because the corresponding economic benefits are uncertain. However, Type III dips do occur (see Chapter 6), and Type III dip immunity specifications will certainly make sense when end-users can justify the involved economic costs.

7.2.3 Interpretation of dip statistics, immunity classes and number of equipment trips

Using the information obtained from the available dip statistics (see Chapter 6), this section presents the results for expected maximum annual number of equipment trips for five proposed dip immunity classes. The results are presented in tabular form, showing the number of dips found when voltage-tolerance curves for each dip immunity class are plotted on dip contour charts for different types of dips and different number of sites (see Appendix 7.A for more detail on dip contour charts).

Instead of showing only one table for available dip data at all sites, different numbers of sites were chosen in order to represent the possible practical ranges of dip frequencies among the different sites. These sites, and corresponding number of dips, were selected as follows:

- 95% of sites (CP95) – this represents the 5% of sites with the highest number of dips in the dip database. The CP95 value should be interpreted in following way: at 95% of the sites, the expected annual number of dips is lower than this value, while at 5% of sites the corresponding number of dips is higher. This case is assumed to represent a “very high exposure site”.
- 75% of sites (CP75) – at 75% of monitored sites, the expected annual number of dips is lower than CP75 value, while at 25% of sites the corresponding number of dips is higher. This case represents a “high exposure site”.
- 50% of sites (CP50) – this represents a “median case”. At 50% of the sites, the expected annual number of dips is lower than CP50, while at the other 50% of sites the corresponding number of dips is higher. This case is assumed to represent a “typical exposure site”.

- 25% of sites (CP25) – at 25% of the sites, the expected annual number of dips is lower than CP25 value, while at 75% of sites the corresponding number of dips is higher. This case is assumed to represent a “low exposure site”.

As mentioned, the CP50 values represent the “typical exposure site”, and these dip data could be used for planning purposes, or to make reasonable economic assumptions and decisions. If there is a requirement to further reduce the risk of equipment tripping, the CP75 or CP95 values can be used. However, the use of these two CP values will probably result in increased costs, as specification of equipment with higher dip immunity levels will be required.

The presented tables apply directly to three-phase equipment. In the case of single-phase equipment (the majority of LV equipment is single-phase, connected phase-to-neutral), and assuming that Types I and Type II dips are equally distributed among the three phases, the numbers from the tables below are: one third for Type I dips, two thirds for Type II dips, and as stated for Type III dips.

The calculated expected annual number of dips are (mostly) based on events recorded at MV and above, due to a general lack of recording at LV. Accordingly, these dips were normalised, in order to represent corresponding LV dip data (for details see Chapter 6).

“TYPICAL EXPOSURE SITE”

	Cumulative probability	Equipment with Class A immunity	Equipment with Class B immunity	Equipment with Class C1 immunity	Equipment with Class C2 immunity	Equipment with Class D immunity
Equipment will trip <u>less</u> than this number per year						
Type I dips	CP50	0	0	1	1	4,5
Type II dips	CP50	0	0	1	1	6,5
Type III dips	CP50	0	1	5	5	6
TOTAL	CP50	0	1	7	7	17

“LOW EXPOSURE SITE”

	Cumulative probability	Equipment with Class A immunity	Equipment with Class B immunity	Equipment with Class C1 immunity	Equipment with Class C2 immunity	Equipment with Class D immunity
Equipment will trip <u>less</u> than this number per year						
Type I dips	CP25	0	0	0	0	2
Type II dips	CP25	0	0	0	0	2,5
Type III dips	CP25	0	0	2	2	2,5
TOTAL	CP25	0	0	2	2	7

“HIGH EXPOSURE SITE”

	Cumulative probability	Equipment with Class A immunity	Equipment with Class B immunity	Equipment with Class C1 immunity	Equipment with Class C2 immunity	Equipment with Class D immunity
Equipment will trip <u>less</u> than this number per year						
Type I dips	CP75	1	1	4,5	5,5	9
Type II dips	CP75	1	1	6,5	7,5	14
Type III dips	CP75	1	4	10,5	10,5	11
TOTAL	CP75	3	6	21,5	23,5	34

“VERY HIGH EXPOSURE SITE”

	Cumulative probability	Equipment with Class A immunity	Equipment with Class B immunity	Equipment with Class C1 immunity	Equipment with Class C2 immunity	Equipment with Class D immunity
Equipment will trip <u>less</u> than this number per year						
Type I dips	CP95	1	4	13,5	17,5	26,5
Type II dips	CP95	1	7	21,5	24,5	38
Type III dips	CP95	4,5	13,5	30	30	35
TOTAL	CP95	6,5	24,5	65	72	99,5

Notes:

For three-phase equipment, the numbers in presented tables for different dip immunity classes and different number of sites show the *maximum* expected number of equipment trips per year. In practical situations, however, equipment will trip *fewer times per year than the numbers in the tables suggest*. Firstly, equipment may *not trip immediately* when a dip below the specification for the particular immunity class occurs, because where the dip immunity of a particular piece of equipment is specified by, e.g. immunity Class B, the actual voltage-tolerance curve of the equipment is better – somewhere between the Class B and Class A immunity curves. Even if actual dip immunity of that equipment is closely specified with the immunity Class B, typical certification tests are usually performed with 10% deeper and 10% longer dips, and there will be at least 10% difference between the actual immunity/voltage-tolerance curve of equipment and immunity/voltage-tolerance curve specified by Class B. Secondly, the actual number of equipment trips will also depend on whether the particular equipment or corresponding part of the process is running or not. For example, if dips are equally spread over the day (i.e. 24-hour period), and the equipment/process is running only 8 hours per-day, seven days a week, the estimated number of equipment trippings (possibly causing process disruptions) is one third of the stated figures. Finally, and as mentioned previously, single-phase equipment will trip even less often.

7.2.4 Equipment Performance Criteria

Clear identification of equipment behaviour during and after voltage dip events is crucial for the assessment of equipment dip immunity. Accordingly, equipment immunity to various types/severities of dip events can be quantified only if clear distinction is made between the two following equipment performance criteria: “normal equipment operation” and “equipment tripping/malfunction”. Generally, a process or equipment (including all components and subsystems) will respond to a voltage dip in one of the following ways:

- Full (normal) operation – equipment performs as expected or intended, and all of its relevant parameters are within technical specification or within allowed tolerance limits. Equipment performance should be expressed and measured against the set of relevant/critical “equipment outputs” (e.g. speed, torque, voltage level, etc.), which have to be defined as per the process requirements.
- Self-recovery – equipment does not perform intended functions, or its outputs vary outside the technical specification/limits, but equipment is able to automatically recover after the end of dip event.
- Assisted-recovery – equipment does not perform intended functions, or its outputs vary outside the technical specification/limits, and equipment is not able to automatically recover after the end of dip event.

Assisted-recovery criteria should be applied only when there are dedicated and/or trained personnel/staff, who either operate the equipment, or are responsible for supervising the equipment at all times when equipment is in use. If some external control circuit is applied for automatic restarting of equipment, this should be treated as a self-recovery criterion.

Note: The above mentioned performance criteria are derived from the pass/fail criteria from standards [1-5]. Standard [4] also discriminates between “general performance” and “special (intrinsic) performance”, where latter can be related to e.g. torque generating behaviour, operation of power electronics and driving circuits, information processing sensing function, or operation of displays and control panels.

7.2.5 Voltage dip immunity labels

In order to fully specify equipment dip performance, equipment immunity class and equipment performance criteria should be combined. In this report, this is done by introducing “voltage dip immunity labels”, which are illustrated in Figure 7-7 for all possible combinations (15 in total).

Voltage dip immunity label		Equipment performance criteria		
		Full operation	Self-recovery	Assisted-recovery
Immunity class	A			
	B			
	C1			
	C2			
	D			

Figure 7-7 Proposed voltage dip immunity labels (combinations of equipment dip immunity classes and equipment performance criteria).

Note: In the most general case, a single piece of equipment might have three different labels. This happens when, for example, an equipment satisfies Class C1 specification for the full operation performance criterion, Class B specification for the self-recovery criterion and Class A specification for assisted-recovery criterion.

7.2.6 Specification of equipment

End-users who decide to buy (or ask for quotations for) equipment according to one of the 15 voltage dip immunity labels, can use one of the corresponding “sample specifications” provided in the Appendix 7.B at the end of this document.

7.2.7 Voltage dip testing for manufacturers, and documentation requirements

An equipment manufacturer, who is producing equipment according to specifications from this document, should follow equipment testing procedures recommended in Chapter 4 and documentation requirements as per the latest IEC 61000-4-11/34, or SEMI F47 standards. Example documentation requirements for equipment testing can be found in Appendix 7.D.

7.3 Assessment and improvement of process dip immunity

This section introduces a general procedure for the assessment and improvement of process immunity against voltage dips. The procedure has several steps/tasks (illustrated in Figure 7-8), whose realisation can be very time consuming and might require technical knowledge or resources that are not available within the end-user's industrial/business premises. As it might not be economically justifiable for end-users to acquire required knowledge on their own, the Working Group proposes a simple and transparent procedure for the assessment/improvement of end-users process dip immunity. Previous sections of this chapter (as well as previous chapters) and appendices provide the reader with additional information, check-lists, recommendations and templates (e.g. for test procedure, dip immunity classes, equipment/process dip ride-through capability, etc).

7.3.1 STEP 1: Supply dip performance

Overview: *"Obtain information about frequency and severity of voltages dips (typically) expected at the terminal(s) where the equipment is (or should be) connected. Sometimes, statistical dip data are available at the point of common coupling (PCC), or at the higher voltage levels, when this information should be carefully processed and interpreted, in order to obtain the supply dip performance at the equipment terminals."*

Voltage dip performances of electrical distribution networks around the world vary in a wide range, depending on the voltage level, type/configuration of the network, feeder impedance between the sources and end-users equipment and other factors. Characteristics of adjacent networks are also important, because fault-caused voltage dips will easily propagate across the electrical networks and towards downstream voltage levels (although downstream transformers have some mitigation effect on voltage dips). On the other hand, the impedance of the source (i.e. feeder or transformer impedance) will usually mitigate fault currents as they try to spread dips upstream, at higher voltage levels (although in weak networks fault-caused voltage dips can impact higher voltage networks).

Overhead networks usually experience higher number of voltage dips than underground networks, because they are exposed to lightning, vegetation, animals, cars, fire, pollution, etc. Nevertheless, faults do occur in underground networks (i.e. all electrical networks are subjected to the faults) and, accordingly, operation of the corresponding fault protection devices will influence characteristics of experienced fault-caused voltage dips.

Additionally, characteristics of the (large) loads connected to the same bus or in vicinity of the end-users facility will influence characteristics of voltage dips and may affect the performance of critical process equipment. Furthermore, voltage dips can be generated inside the end-user facility, when, for example, motor starting procedures or locked-rotor conditions may cause voltage dips and influence overall process performance.

Accordingly, supply dip performance should be assessed at the PCC or at the point where the critical process equipment is connected. Therefore, supply dip performance is normally monitored by the local utility/power supply company at the PCC, or by the end-user at the point/terminal where the equipment is/should be connected.



PROCEDURE TO IMPROVE PROCESS IMMUNITY AGAINST VOLTAGE DIPS

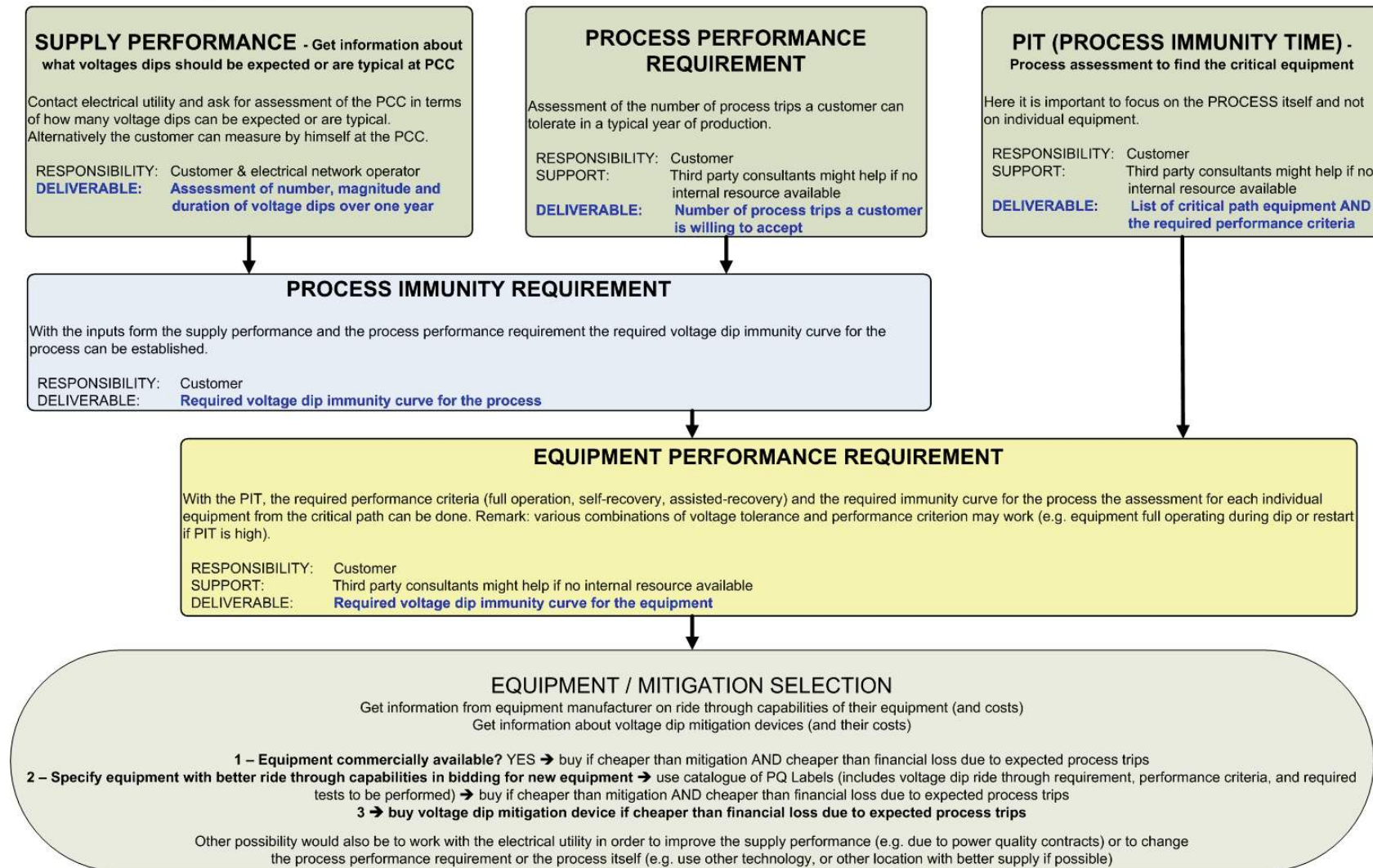

Figure 7-8 Flow chart of the methodology to improve process immunity against voltage dips.

For sites where voltage dips cannot be recorded, local electrical utility may be able to indicate frequency and severity of voltage dips that could be expected in their network at the nearest PCC. This data may be available by geographic sub-regions within the utility's territory, or utility may use SARFI index [6], or urban, sub-urban and rural network classification [7] for the presentation of available voltage dip statistics.

Chapters 2 and 6 provide some general discussion on monitoring/recording voltage dips for characterisation of supply performance, stating that minimum one year monitoring period is recommended for evaluation of voltage dips, since their occurrence greatly depends on weather conditions. Longer monitoring periods are also common, as the weather can also change significantly from one year to another. Lightning is probably the most important weather-related factor, strongly influencing frequency of dip events in most regions. For the assessment of these dips, statistics are available on a long term evaluation of lightning in terms of flash density (flashes/km²/year) and the number of days with flashes per year level. This data is normally available for each area worldwide from a local weather networks. Where relevant, other forms of severe weather could also be taken into account when evaluating voltage dips performance of an electrical network.

An example of supply dip performance is presented in Figure 7-9.

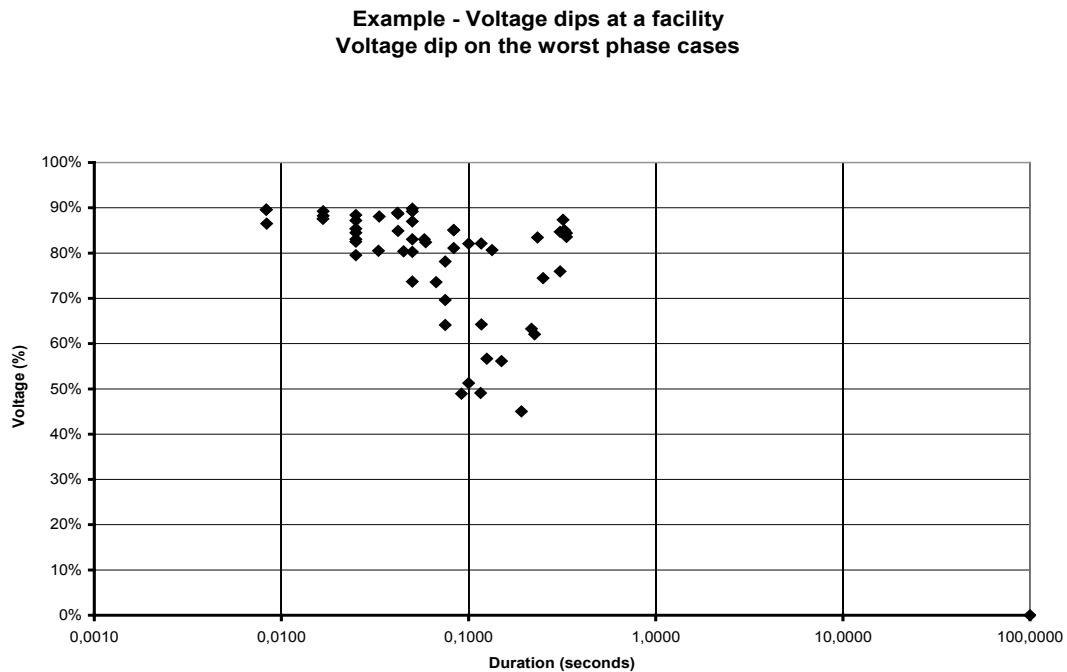

Figure 7-9 Voltage dips recorded at an end-user facility over a 1.5 year period.

Note: Each point on the graphs/figures shown in this section represents “the worst phase case”, i.e. the lowest rms voltage recorded using a half-cycle refreshing window on each of the three phases, with the corresponding total dip duration.

Figure 7-9 provides graphical representation, while corresponding numerical dip data for some of the shown voltage dips are given in table below. In this example, measurements were performed on the secondary side of a voltage transformer connected to a 12.47 kV bus in a utility substation.

#	Date	Time	Type	Duration (seconds)	Remaining voltage (%)
1	2002-02-01	14:31:28	II	0,1000	51%
2	2002-02-01	14:53:57	II	0,0833	81%
3	2002-02-01	14:57:17	III	0,1167	82%
4	2002-02-01	16:48:17	II	0,1333	81%
5	2002-03-03	20:59:01	III	0,2500	74%
6	2002-03-11	2:18:10	I	0,0250	85%
7	2002-03-21	18:56:01	I	0,3250	85%
...

The data from the above table can be used to determine the immunity of end-user's equipment located on a dedicated feeder near the location for which this dip data is provided. As mentioned in Chapter 2, additional columns could be added to this table, showing further dip characteristics of interest, for example, remaining voltage on each phase, phase shift, point-on-wave values, etc. Other parameters of dip events, such as (electrical) location and configuration of the measuring point and power transformer can also be provided.

7.3.2 STEP 2: Process performance requirement

Overview: "Assess the number of process disruptions due to voltage dips identified in Step 1 and their economical impact and consequences. Determine the number of process disruptions and corresponding financial losses that an end-user can tolerate in a typical year of production."

Each process needs to be evaluated regarding its own voltage dip performance requirement. This evaluation could be general, e.g. based on the process dip immunity assessment using similar types of equipment, or it could be specific to each individual site. Special care should be taken in the case of general evaluation, as the same equipment may be used in different industrial environments, where it usually has to meet different requirements, depending on its function in the process. What drives the importance of immunity to voltage dips is the economical aspect of process immunity. The cost of lost production, as discussed in Chapter 5, is influenced by a large number of factors, and losses need to be evaluated for each voltage dip that has an impact on the production throughout a year. By logging this data and the data of recorded voltage dips, it becomes possible to determine the level of process performance requirements (i.e. losses) which are economically acceptable for the end-user. When process is complex, or has several independent/parallel parts, this assessment should be performed on a part-by-part (i.e. sub-process-by-sub-process) basis.

The best way to obtain data on production losses would be to get all relevant information correlating production stoppage or disruption with the occurrence of a voltage dip. The minutes following a dip-caused process disruption may be crucial for the assessment of dip impact on production. Sometimes, some process parameter may be considered as not important, but could in fact be the source of a large impact on the production. An example would be when the production does not seem to be affected by a voltage dip, but some ancillary services stops (such as an air compressor), causing a delay in the production or, even worse, affecting the quality of the product.

If a new site is considered, then it is important to start with an evaluation of voltage dips at the PCC, or at the nearest available dip monitoring location on the same voltage level (usually available from the utility). Afterwards, process performance requirements can be specified to the designer of the new plant (for more detail see Chapter 5).

Voltage dips on the worst phase cases

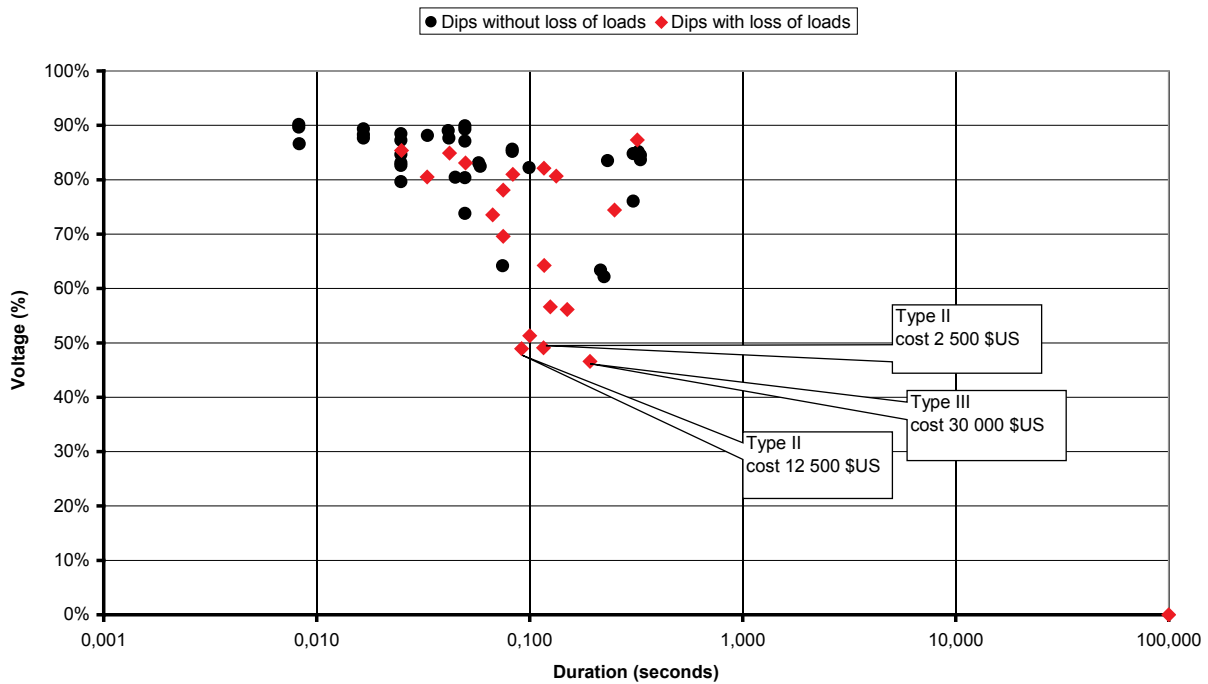

Figure 7-10 An example of voltage dip impact on a process.

Figure 7-10 shows, for an existing factory, an example of the impact of the recorded voltage dips on the whole process. Because it is possible to correlate occurrence of voltage dips with the corresponding financial losses, process engineers can evaluate the impact of each of these dips. A first step is to determine which voltage dips have considerable impact on the process. The accuracy of this evaluation will depend on the data collected after each dip event. At this step, an economical evaluation for each dip/point in Figure 7-10 should be provided, either by the process engineers, or an estimation based on experiences from similar industries can be used [8]. With the economical evaluation of annual losses caused by voltage dips, an appropriate process performance requirement can be set by the end-user.

7.3.3 STEP 3: Process immunity requirement

Overview: "With the inputs from the supply dip performance and process performance requirement, the required voltage dip immunity class for the whole process can be established. If necessary, additional requirements for each part of the process (i.e. sub-process) can also be established."

The determination of the process immunity requirement is based on collected information about the supply dip performance and process performance requirement. With the knowledge of the actual statistical dip data (e.g. graph showing dip types, magnitudes and durations, Figure 7-9), as determined in Step 1, and costs of these dips to the process, as determined in Step 2 and Figure 7-10, it is possible to make an economic decision on desired voltage dip immunity requirement for the whole process, or part of the process. The advantage of defining a voltage dip immunity requirement for the whole process, or sub-processes, is that corresponding technical specifications for individual process equipment will be based on clearly identified economic justification.

Voltage dips on the worst phase cases

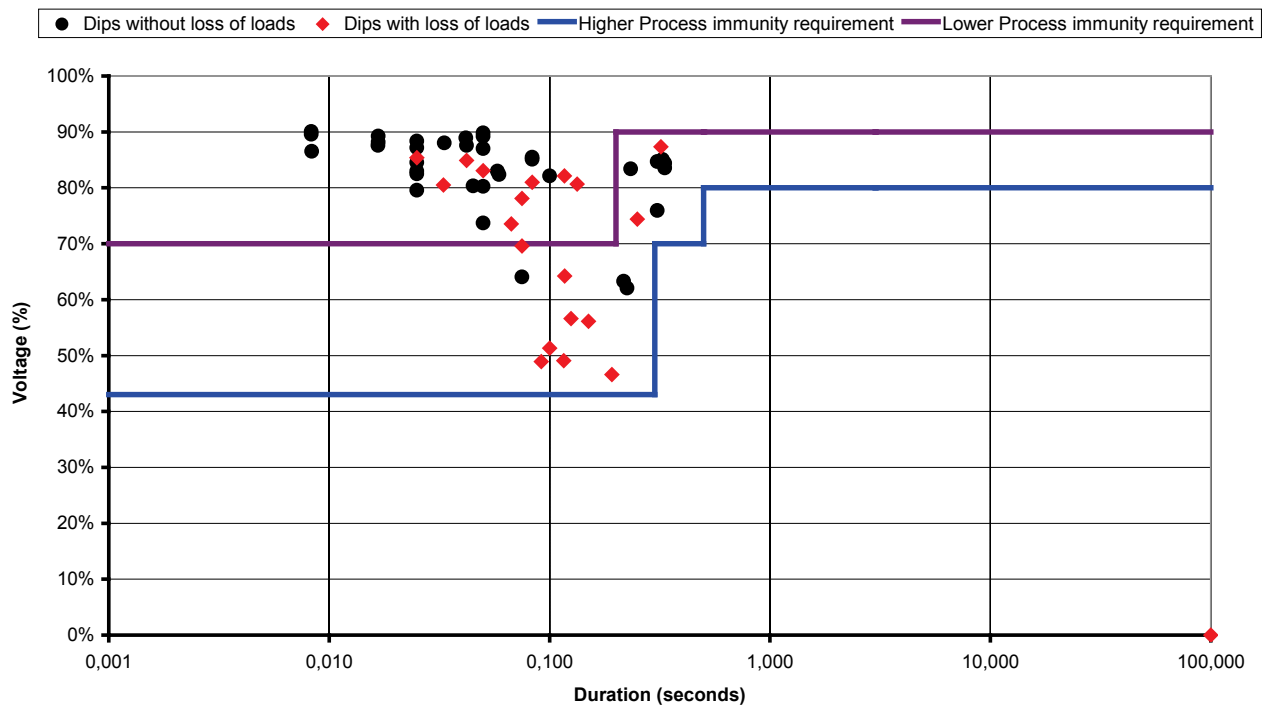

Figure 7-11 An example of selecting/specifying process immunity requirement.

Based on Figure 7-11, an appropriate process immunity requirement can be selected, depending on the return of investment ("higher immunity/cost" or "lower immunity/cost"). This requirement will set the overall dip immunity level that the process should achieve, and will therefore influence next steps from the proposed procedure. In Section 7.3.5 it is shown how this requirement should be associated with the previously proposed dip immunity classes (Step 5).

7.3.4 STEP 4: Process immunity time (PIT)

Overview: *"Perform assessment of process dip immunity to identify critical equipment within the process, or critical parts of the process. The assessment in this step should go as far as needed to determine what piece(s) of equipment needs to be immune against voltage dips, and what are their required levels of dip immunity."*

Chapter 3 defined a tool, the Process Immunity Time (PIT), which helps to characterise process dip immunity in terms of critical equipment within the process and/or critical parts of the process ("sub-processes"). The assessment of the PIT needs to be done before writing a technical specification for (new or upgraded) process equipment. The same equipment, for example, may be critical for one process (where it may require the highest level of dip immunity), while in another process it may not need any level of dip immunity other than the automatic or manual restart. The process immunity time assessment will help to determine what level of dip immunity needs to be specified for each piece of process equipment.

As the assessment of the entire process dip performance is important, the process needs to be studied in parts, and for each part a time constant (i.e. PIT) should be determined. This time constant is the time for which equipment can tolerate a voltage dip (or can be restarted after tripping) without affecting the process. At the end of this assessment, it is usually a single piece of equipment or combination of several pieces of equipment that causes the process to trip. All equipment that does not operate in accordance to the expected performance during and after a voltage dip, but does not have much impact on the whole process, can be neglected during the assessment.

For the correct dip performance assessment, it is important to understand the whole process. This makes it necessary to involve key personnel from several departments into the assessment. Process engineers can tell in detail if (and when) the process will fail after the electrical equipment stops, and how much time is available to restore/restart the function of the equipment before the process is disrupted. Process control and automation engineers should be also involved, in order to ensure that control and protection systems will not interfere when the equipment is "back" within the time specified by the corresponding PIT value. For example, equipment may malfunction because of too sensitive setting of its protection, which is often designed without considering the impact of voltage dips. In such cases, it is important to get detailed information from the manufacturer about the protection settings and how these settings can be re-adjusted to make equipment less sensitive without damaging it. The focus should not only be on the control and protection of larger equipment, but also on the instrumentation and sensing devices that could have been upset during the voltage dip. The third important discipline is process design, which is needed to understand, for example, mechanical constraints of the involved equipment. In the most general case, interaction of engineers from several disciplines is necessary to understand the overall dynamic behaviour of a process during a voltage dip. Sometimes, it might also help to contract an external consultant to conduct and facilitate the assessment of the process immunity time.

At the end of a process immunity time assessment, the end-user should have a list of PIT values for the process and all relevant/critical sub-processes and individual pieces equipment. Chapter 3 and Appendix 7.C provide more detail (and practical examples) related to the assessment of process immunity time.

7.3.5 STEP 5: Equipment performance requirement

Overview: "With the established process immunity requirement and data from the PIT assessment, the requirement for dip performance of individual equipment can be selected as per voltage dip immunity class. Note: Various combinations of voltage tolerance curves and performance criteria may be appropriate (e.g. full operation for critical equipment with low PIT value, or self-recovery if PIT is high)."

After the PIT values for all (critical) equipment and parts of the process are determined based on the economical immunity requirement, the decision can be made on the choice of equipment with appropriate dip immunity. For this purpose, voltage dip immunity labels introduced in Section 7.2 should be used, specifying dip immunity class and performance criteria for equipment within the process which is installed, or is to be installed.

Clear definition and identification of malfunction criteria are crucial in this step. Requirements for equipment dip performance can be measured and quantified only if clear distinction is made between the normal operation of equipment and its malfunction. The malfunction of the equipment represents all situations in which equipment is no longer able to perform its intended functions, or terminates its ability to control other equipment, or starts to perform unintended functions. General causes of equipment malfunction are discussed in Chapter 5, Section 5.4.1, while Section 7.2.4 in this chapter introduced three general performance (i.e. malfunction) criteria suggested for the assessment of equipment dip performance.

Adequate voltage dip immunity labels should be selected for each individual piece of equipment: for processes with long PIT values, corresponding equipment can be specified with self-recovery or assisted-recovery performance criteria, while for processes with short PIT values, the only suitable performance criteria for equipment is full operation.

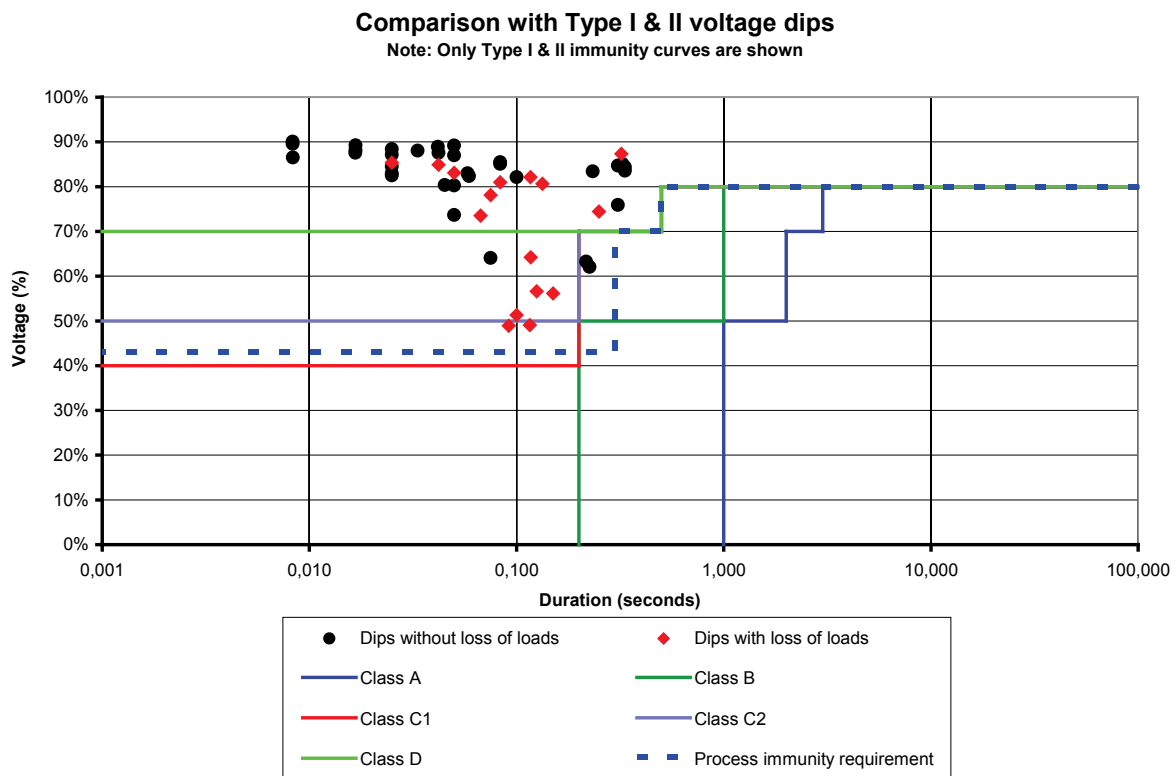

Figure 7-12 An example of selecting equipment performance requirement for Type I and Type II voltage dips.

In Figures 7-12 and 7-13, the required process immunity curve is shown by dotted blue line. Based on Figure 7-12, if an end-user needs to specify equipment that will be able to ride-through all Type I and Type II “dips with loss of load” (marked by red-diamonds), and if the required equipment performance criteria is “full operation”, the equipment should be specified with voltage dip immunity label “C1, full operation” (required level of dip immunity). Alternatively, since the three dips with the lowest magnitudes are very close to C2 voltage-tolerance curve, it may be more appropriate to specify “C2, full operation” voltage dip immunity label, particularly if equipment with label C2 is less expensive than equipment with label C1. If the end-user is willing to accept number of process disruptions specified by the class D immunity curve (corresponding roughly to the “lower process immunity requirement” curve in Figure 7-11), equipment can be specified with label “D, full operation”, which should result in a lower cost of the equipment.

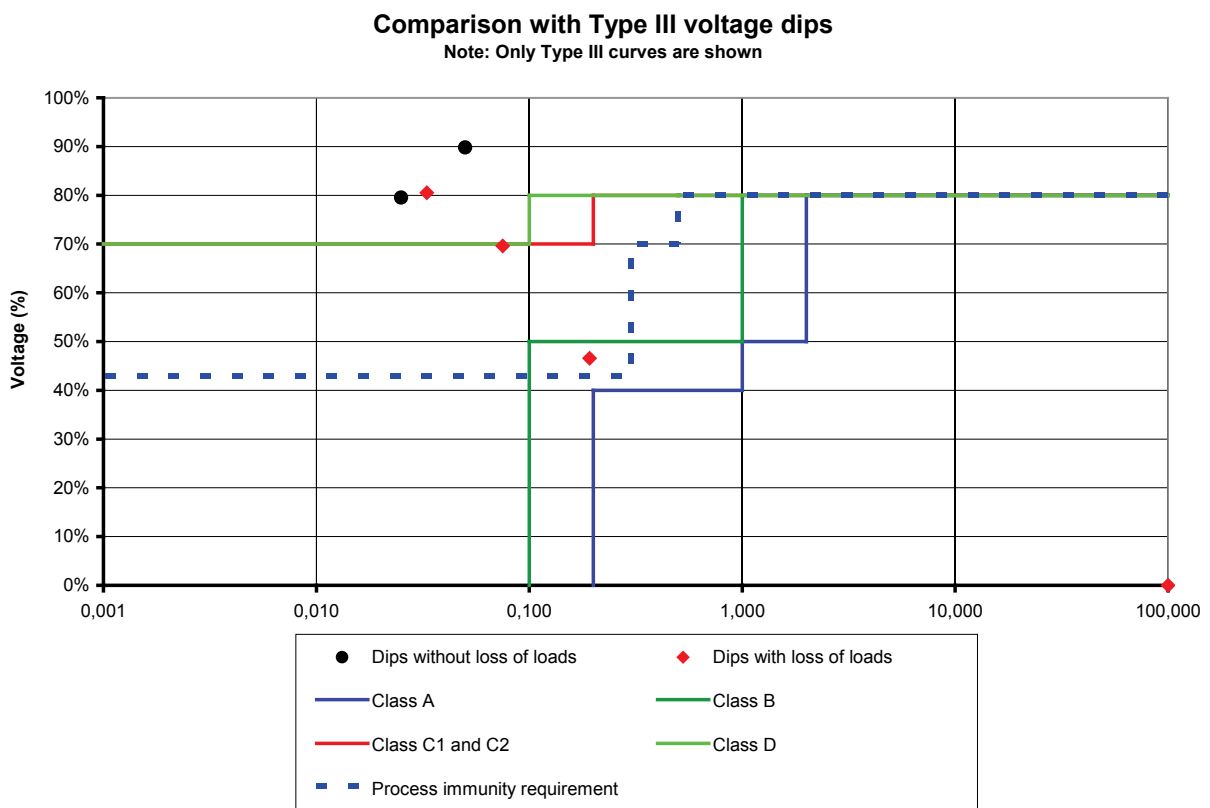

Figure 7-13 An example of selecting equipment performance requirement for Type III voltage dips.

It can be seen from Figure 7-13 if the same voltage dip immunity label ("C1" or "C2") is specified for equipment dip performance against Type III dips, there will be one dip event that the equipment will not be able to ride-through it. If this cannot be tolerated, voltage dip immunity label "A, full operation" needs to be specified. This decision has to be carefully evaluated, as the cost of equipment with label "A, full operation" could be significantly higher than the cost of equipment with label "C1, full operation" or "C2, full operation".

7.3.6 STEP 6: Selection of equipment or mitigation devices/measures

Overview: *"In the final step, dip performance/immunity specification for critical pieces of equipment within the process should be formulated (see Appendix 7.B, which can be simply copied and pasted into the technical specifications for equipment and corresponding requests for quotation)."*

Once the end-user knows voltage dip sensitivity of his process and how involved equipment within the process must respond to dip events, he can decide what voltage dip immunity label is desirable for each (critical) piece of involved equipment. The emphasis should be on a balance between dip immunity requirements and equipment costs, as it is easy to specify high dip immunity of equipment, but the result should not be an unjustifiable increase in equipment costs. Appendix 7.C gives an example of the application of this methodology through a case study of a pharmaceutical plant.

The end-user should contact equipment manufacturers and ask for the information about the voltage dip immunity/performance of their equipment. Appendix 7.B gives description of the proposed voltage dip immunity labels, which may be used as the equipment dip performance specification and sent to the manufacturer. It might happen that manufacturers do not have data on dip immunity of their equipment available in this format (i.e. voltage dip immunity labels), and that their equipment need to be tested (see Appendix 7.D). Although these tests might increase manufacturing costs and might result in a higher equipment price, they will allow simple and transparent exchange of information on equipment dip immunity between manufacturers and end-users. It also should become a common practice for manufacturers to make some minimum dip performance tests of their equipment, and this Working Group emphasises the importance of getting dip performance data for at least critical equipment within the process. For equipment with dedicated protection circuits, the manufacturer should also provide a detailed explanation of the protection settings, how they can be changed and what are the effects of these changes.

If there is no commercially available equipment with specified or required dip performance/immunity levels, there are three following general alternatives:

- Buy commercially available equipment with lower dip performance
- Order custom-made equipment
- Buy appropriate mitigation device.

Alternative way for solving voltage dip immunity problems is to add an "in front" equipment, able to mitigate the effects of voltage dips. This document, however, does not address all the different mitigation methods.

7.4 References

- [1] Electromagnetic compatibility (EMC), Part 4: Testing and measurement techniques, Section 11: Voltage dips, short interruptions and voltage variations immunity tests, IEC Standard 61000-4-30, International Electrotechnical Commission, 2004.
- [2] Electromagnetic compatibility (EMC), Part 4: Testing and measurement techniques, Section 11: Voltage dips, short interruptions and voltage variations immunity tests for

equipment with input current more than 16 A per phase, IEC Standard 61000-4-30, International Electrotechnical Commission, 2005.

- [3] Semiconductor Equipment and Materials International (SEMI), Specification for semiconductor processing equipment voltage sag immunity, SEMI Standard F47-07, 2006.
- [4] Adjustable speed electrical power drive systems, Part 3: EMC requirements and specific test methods, IEC Standard IEC 61800-3, 2004.
- [5] Electromagnetic compatibility (EMC), Part 6: Generic standards, Section 1: Immunity for residential, commercial and light-industrial environments, IEC Standard 61000-6-1, International Electrotechnical Commission, 2005.
- [6] IEEE P1564/D6, Recommended practice for the establishment of voltage sag indices, May 2004.
- [7] Canadian Power Quality Survey 2000, CEATI report #T984700-5103, May 2001.
- [8] WEB site : Energy Central Network ref. to M. McGranaghan, & al: EC&M article.

Appendix 7.A: Dip contour charts for the representation of dip statistics²

Development of voltage dip coordination charts

Dip coordination charts show supply dip characteristics and end-user equipment response to voltage dips on a single graphical display. The foundation for the display is an XY grid of dip magnitude (the minimum of three voltages) on the vertical axis and dip duration on the horizontal axis. In the method presented here, a family of "contour lines" illustrate the supply dip performance. Each contour line represents a specific number of dips per year.

An "equipment line" on the same chart shows the equipment voltage-tolerance curve. Proper use of the dip coordination chart enables the estimation of the number of end-user equipment malfunctions due to voltage dips.

Two data sets are critical for assembling the dip coordination chart. First, the supply dip characteristics must either be known from monitoring data, or predicted/calculated from e.g., stochastic computer simulations. Second, end-user equipment response to dips must be known either from manufacturer specifications, or from performance test data.

Presentation of supply dip performance

The display of supply characteristics requires either monitoring results or predicted dip magnitudes and durations. This data fills magnitude and duration bins in a matrix or table e.g. in a computer spreadsheet. The data is presented graphically as contour lines. A very simple example in the text below illustrates fundamental concepts.

Table 7-1. Count of events in each bin.

Magnitude Bin	Time Bin in Seconds				
	0.0 <0.2	0.2 <0.4	0.4 <0.6	0.6 <0.8	>= 0.8
>80-90%	1	1	1	1	1
>70-80%	1	1	1	1	1
>60-70%	1	1	1	1	1
>50-60%	1	1	1	1	1
>40-50%	1	1	1	1	1
>30-40%	1	1	1	1	1
>20-30%	1	1	1	1	1
>10-20%	1	1	1	1	1
0-10%	1	1	1	1	1

² Text of this appendix is based on the following paper: L.E. Conrad, M.H.J. Bollen, Voltage sag coordination for reliable plant operation, IEEE Trans. on Ind. Applications, Vol.33, No.6, Nov. 1997. The methodologies and terminology used in this appendix may be different from the ones used in the rest of the report.

Table 7-1 shows a grid/table with nine dip magnitude ranges in rows and five dip duration ranges in columns. The combination of nine rows and five columns produce a total of 45 magnitude/duration bins. Every measured or predicted dip will have a magnitude and duration that fits in only one of the 45 bins. The number of bins may vary depending on coordination requirements for a particular case. However, this selection of 45 bins is reasonably convenient.

For a simple example, assume each of the 45 bins has one dip per year. This means that there are 45 dips per year and the characteristics of each dip (minimum magnitude/total duration) place it in a unique bin. The values from 15 bins in the lower right corner are highlighted in italics, as they will be considered in this example in more detail.

Table 7-2 shows the *cumulative* number of dip events that are *worse than or equal* to each bin from Table 7-1. "Worse than" means that the magnitude is lower and the duration is longer (i.e. these dip events are more severe from equipment point of view). The row and column headings now only show single values instead of ranges. For example, there are 15 dips in the "50% magnitude – 0.4 second" entry of Table 7-2. The highlighted number 15 in Table 7-2 is the sum of all 15 individual highlighted entries in Table 7-1, i.e. 15 dips with magnitude less than or equal to 50% and a duration longer than or equal to 0.4 seconds.

Table 7-2. Sum of events worse than or equal to each magnitude and duration.

Magnitude	Time in Seconds				
	0.0	0.2	0.4	0.6	0.8
90%	45	36	27	18	9
80%	40	32	24	16	8
70%	35	28	21	14	7
60%	30	24	18	12	6
50%	25	20	15	10	5
40%	20	16	12	8	4
30%	15	12	9	6	3
20%	10	8	6	4	2
10%	5	4	3	2	1

The next step converts Table 7-2 to a set of contour lines similar to altitude/isohyps lines on a geographic map. Figure 7-14 is the contour plot of Table 7-2, generated by a computer spreadsheet and graphics program. The lines going from lower left corner to upper right corner represent the number of dip events per year. Each contour line has a label for the corresponding number of dip events.

Continuing the simple example, the 15 event contour line intersects the 0.4 second vertical

line for 50% magnitude horizontal line. This means that 15 dips will have 0.4 seconds or longer duration and 50% or lower magnitude. The dots on the lower right corner of Figure 7-14 show each of the 15 individual dips from Table 7-2. There are 15 dots in the rectangular area below and to the right of the 15-dip contour line. Similarly, the 20 dip contour shows that there are 20 dips worse than or equal to 0.2 second and 50% magnitude. Normally, the dots corresponding to individual dips will not appear on dip contour charts.

Linear interpolation between contour lines and axis works reasonably well, especially in this case where the dips are distributed uniformly. For example, about 32 dips will be worse than or equal to 0.2 second and 80% magnitude on Figure 7-14. Also, 25 dips will be worse than about 0.28 second and 70% magnitude on Figure 7-14.

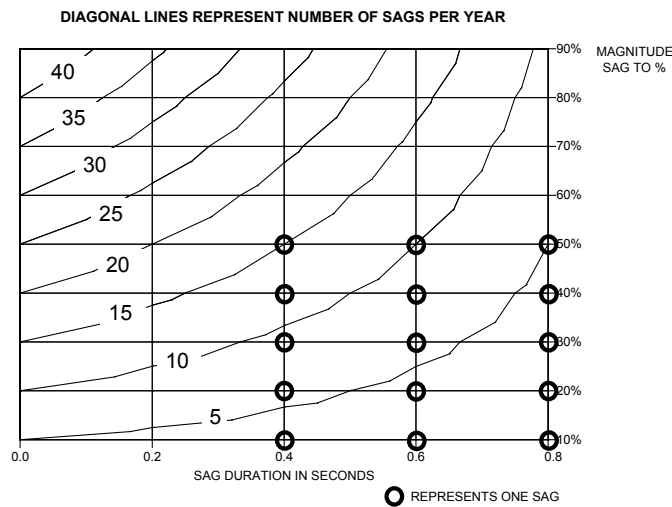

Figure 7-14. Presentation of supply dip performance: contour lines and individual dips.

Adding rectangular equipment voltage-tolerance curve

The voltage-tolerance curve of equipment describes the equipment sensitivity to voltage dips. This curve gives the minimum magnitude that the equipment can withstand for a given dip duration. It can be obtained from the equipment manufacturer, from equipment testing, from equipment simulation, or in future possibly from standards stating typical (or minimum requires) equipment dip immunity. From the results related to measured voltage tolerance curves in several publications, it appears that a rectangular shape of voltage-tolerance curve is very common. The dip contour line method works very easy with these rectangular sensitivity curves. Figure 7-15 overlays the equipment voltage-tolerance curve on the dip contour lines. The shaded region shows the magnitudes and durations of dips which will cause equipment malfunction. The intersection of the knee of rectangular voltage-tolerance curve with the dip contour line gives the number of dips that will trip the equipment. Continuing the simple example on Figure 7-15, the knee of the equipment voltage-tolerance curve intersects the 15-dip contour line. This means that this specific equipment will experience 15 malfunctions per year.

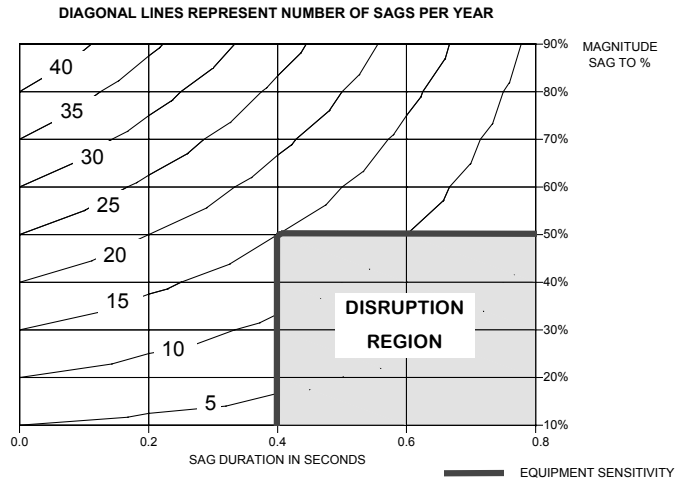

Figure 7-15. Supply dip performance contour lines and rectangular equipment voltage-tolerance curve.

Non-Rectangular equipment voltage-tolerance curve

The previous analysis assumes that the equipment voltage-tolerance curve has a rectangular shape. Non-rectangular voltage-tolerance curves require a little more effort, as they have to be approximated through a number of rectangular steps. Consider Figure 7-16 as an example. The equipment sensitivity is characterised or approximated by a shape with two knees. The malfunction region is the combination of all three shaded rectangular areas A, B and C. Knee #1 is positioned on the 20-dip contour line, while Knee #2 is at about the 24-dip contour line (this value is obtained using linear interpolation). A third “knee” for area C is at the 15-dip contour line.

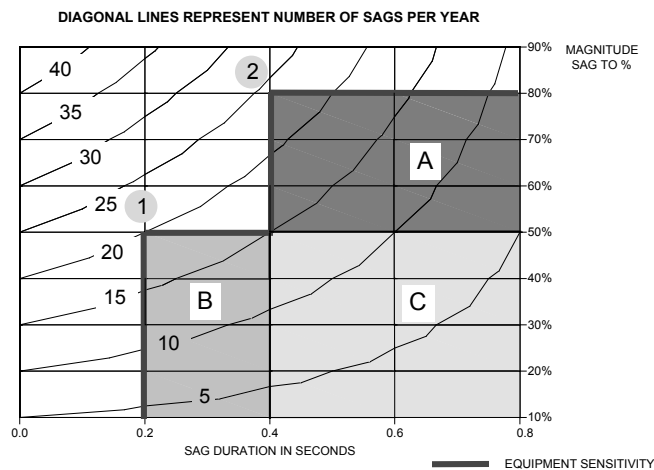

Figure 7-16. Supply dip performance contour lines and approximation of nonrectangular equipment voltage-tolerance curve.

The curve with only Knee #1 is rectangular, consisting of area B and area C. Equipment with such a curve would trip 20 times, for 20 dips in this two areas. Likewise, area A and area C (Knee #2) represent equipment that would trip 24 times, for 24 dips in these two areas. Notice that area C is shared by both curves, and by simply adding dips for Knee #1 and Knee #2 number of equipment trips will be overestimated, as dips in C will be counted twice. In order to prevent that, the analysis presented in the text below should be applied.

$$\text{Total number of dips} = \text{area } A + \text{area } B + \text{area } C. \quad (1)$$

For Knee #1, there are 20 dips. Therefore,

$$B + C = 20 \quad (2)$$

For Knee #2, interpolation is required. Interpolation gives about 24 dips. Therefore

$$A + C = 24 \quad (3)$$

Area C represents 15 dips. Thus $C = 15$. With (2) and (3) it is now easy to find that $A=11$ and $B=5$.

Substituting in (1) gives the total number of dips:

$$A + B + C = 5 + 9 + 15 = 29 \text{ dips causing malfunction of equipment} \quad (4)$$

Thus, the dip coordination chart predicts 29 malfunctions per year for equipment with this non-rectangular voltage-tolerance curve. A simple counting effort of individual dips in Figure 7-16 (presented with the dots in Figure 7-14) confirms the 29 malfunctions. (It is also possible to overlay the equipment sensitivity over Table 7-1, and count the total number of dips.)

Appendix 7.B: Sample specifications of voltage dip immunity labels
Class A

As proposed by CIGRE-CIRED-UIE Joint Working Group C4.1.10

Equipment Immunity Specification
Voltage dip immunity Class A

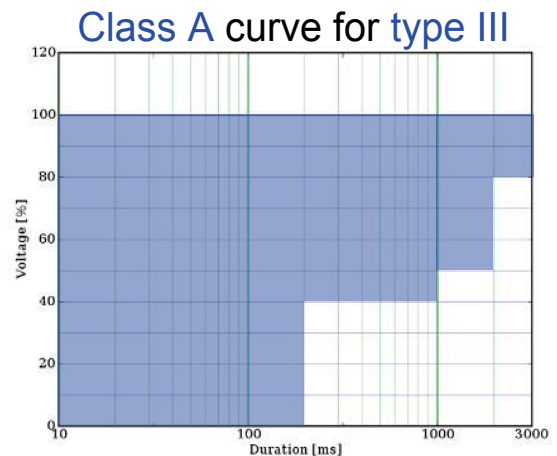
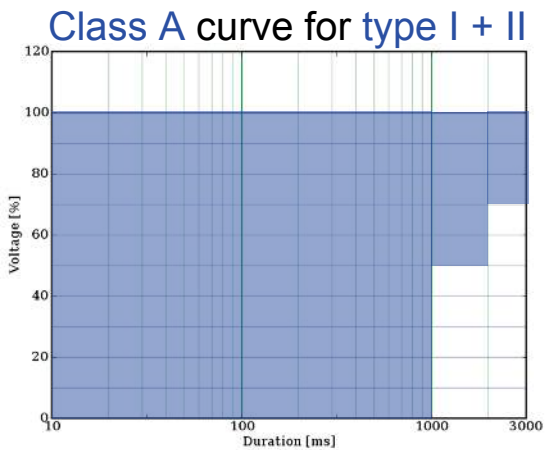

Voltage dip immunity label

Pass / Fail criteria

Full operation

Self-recovery

Assisted-recovery

Immunity class

A

Testing Procedure Requirements

Testing for Type I and II voltage dip required :

- 70% for 3 seconds
- 50% for 2 seconds
- 0% for 1 second

(Testing methods shall be according to IEC-61000-4-11 & IEC-61000-4-34)

Testing for Type III voltage dip required :

- 80% for 3 seconds
- 50% for 2 seconds
- 40% for 1 second
- 0% for 200 milliseconds

Class B

As proposed by CIGRE-CIRED-UIE Joint Working Group C4.1.10

Equipment Immunity Specification

Voltage dip immunity Class B

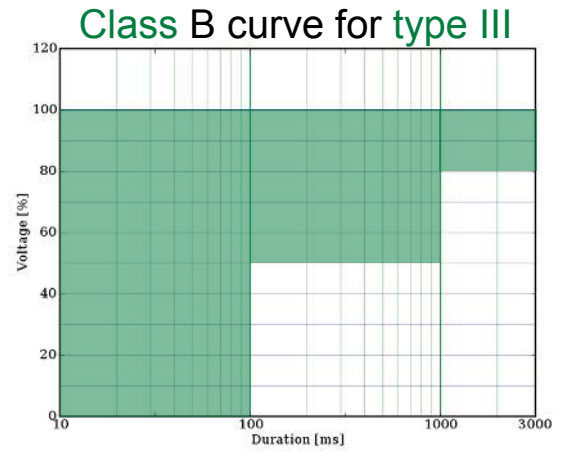
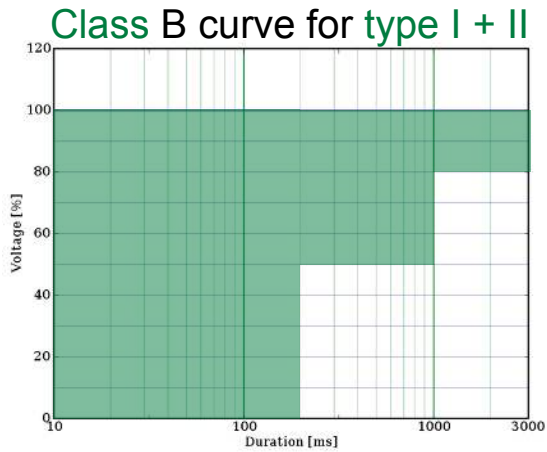

Voltage dip immunity label		Pass / Fail criteria		
		Full operation	Self-recovery	Assisted-recovery
Immunity class	B	<input type="checkbox"/>	<input type="checkbox"/>	<input type="checkbox"/>

Testing Procedure Requirements

Testing for Type I and II voltage dip required :

- 80% for 3 seconds
- 50% for 1 second
- 0% for 200 milliseconds

(Testing methods shall be according to IEC-61000-4-11 & IEC-61000-4-34)

Testing of Type III Voltage dip required

- 80% for 3 seconds
- 50% for 1 second
- 0% for 100 milliseconds

Class C1

As proposed by CIGRE-CIRED-UIE Joint Working Group C4.1.10

Equipment Immunity Specification

Voltage dip immunity Class C1

Class C1 curve for type I + II

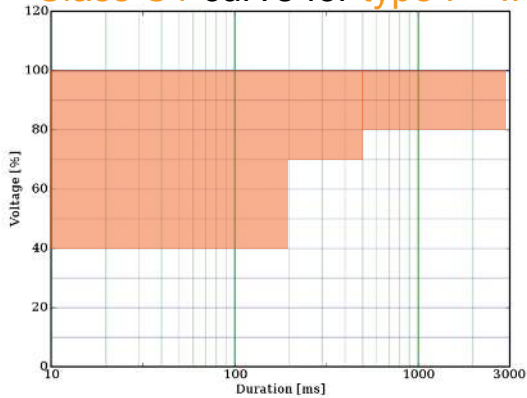

Class C1 curve for type III

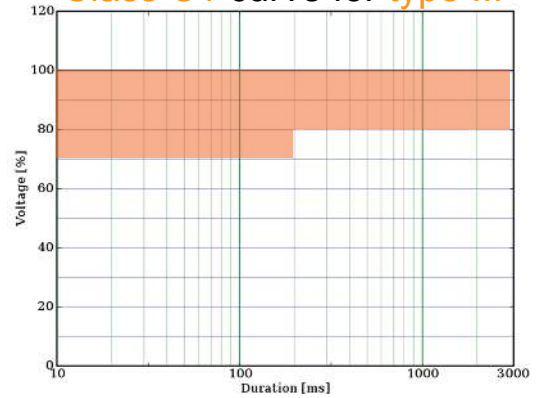

Voltage dip immunity label

Pass / Fail criteria

Full operation

Self-recovery

Assisted-recovery

Immunity class

C1



Testing Procedure Requirements

Testing for Type I and II voltage dip required :

- 80% for 3 seconds
- 70% for 500 milliseconds
- 40% for 200 milliseconds

(Testing methods shall be according to IEC-61000-4-11 & IEC-61000-4-34)

Testing for Type III voltage dip required :

- 80% for 3 seconds
- 70% for 200 milliseconds

Class C2

As proposed by CIGRE-CIRED-UIE Joint Working Group C4.1.10

Equipment Immunity Specification

Voltage dip immunity Class C2

Class C2 curve for type I + II

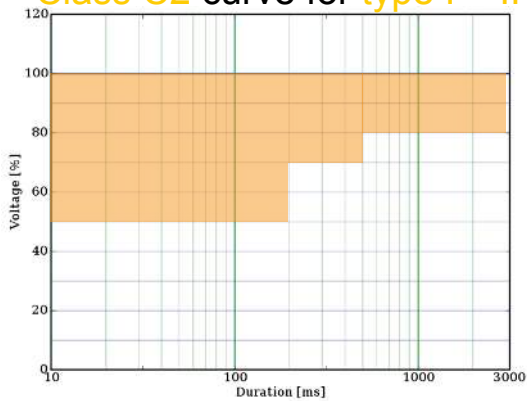

Class C2 curve for type III

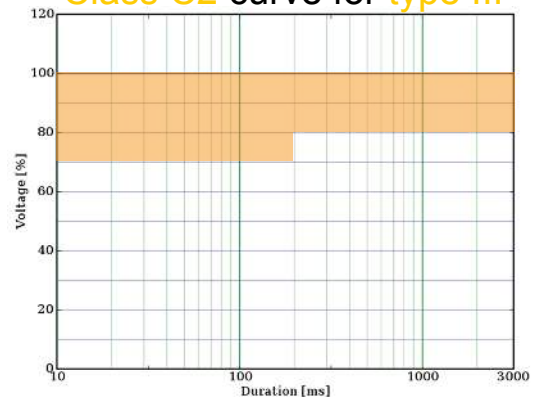

Voltage dip immunity label

Pass / Fail criteria

Full operation

Self-recovery

Assisted-recovery

Immunity class

C2



Testing Procedure Requirements

Testing for Type I and II voltage dip required :

- 80% for 3 seconds
- 70% for 500 milliseconds
- 50% for 200 milliseconds

(Testing methods shall be according to IEC-61000-4-11 & IEC-61000-4-34)

Testing for Type III voltage dip required :

- 80% for 3 seconds
- 70% for 200 milliseconds

Class D

As proposed by CIGRE-CIRED-UIE Joint Working Group C4.1.10

Equipment Immunity Specification

Voltage dip immunity Class D

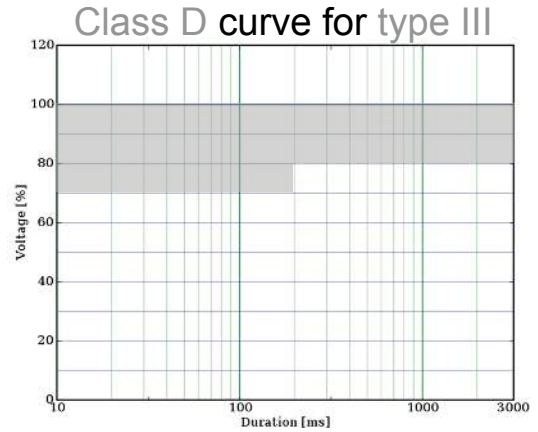
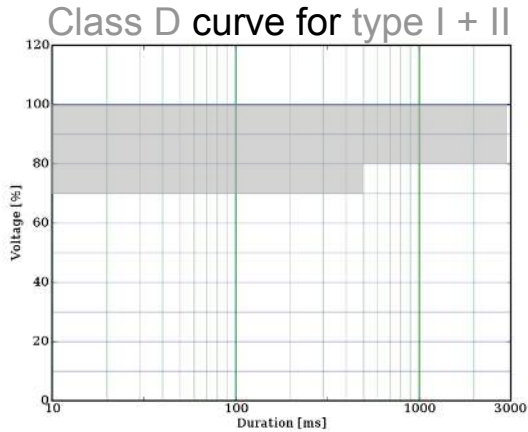

Voltage dip immunity label		Pass / Fail criteria		
		Full operation	Self-recovery	Assisted-recovery
Immunity class	D	<input type="checkbox"/>	<input type="checkbox"/>	<input type="checkbox"/>

Testing Procedure Requirements

Testing for Type I and II voltage dip required :

- 80% for 3 seconds
- 70% for 500 milliseconds

(Testing methods shall be according to IEC-61000-4-11 & IEC-61000-4-34)

Testing for Type III voltage dip required :

- 80% for 3 seconds
- 70% for 200 milliseconds

Appendix 7.C: Assessment and improvement of process dip immunity: A case study of a continuous industrial process³

Introduction

This appendix presents a step-by-step procedure for the analysis of the effects of voltage dips on sensitivity of a continuous manufacturing process in a typical pharmaceutical plant. The procedure includes analysis of voltage dip performance at the point of common coupling and their propagation to equipment terminals; modelling of critical electronic equipment and its sensitivity to voltage dips; establishing the process immunity time constant and finally examining mitigating options for the improvement of process immunity to voltage dips.

The presented results and discussions offer a comprehensive analysis based on various scenarios and operating conditions, and give a wide breadth of different options for achieving the most optimal and cost effective solution.

Finally, the study explores various potential solutions and scenarios from a practical applications point of view, i.e. by taking into account solution feasibility and commissioning time frame, costs and modifications to existing system.

Case study background

A typical pharmaceutical high-cost impact drug-based aseptic manufacturing site is considered in the study. Like most similar processes, it has an obligation to comply with the stringent sterility standards set by various drug regulatory bodies (World Health Organisation, Food and Drug Administration, Medicines and Healthcare products Regulatory Agency etc). A complex HVAC (Heating Ventilation and Air Conditioning) system is usually used to maintain the sterile environment in the production area by enforcing a positive pressure difference between the production area and the external areas surrounding it.

The structure of the sterility regime could be imagined as concentric layers, with the most sterile environment at its core (production area) and relaxed sterility as layers move further away from the production area. In fact, two-thirds of the entire manufacturing unit area is the HVAC system that maintains the sterile environment of one-third of the production area where the drug is manufactured (Figure 7-17). The HVAC system, consisting of ducts, fans, motors, etc., maintains this sterility by providing a constant flow of clean air circulation to enable a positive difference in pressure. Induction motors (IMs), typically used as a constituent part of an HVAC system, are generally driven/controlled by ASDs.

Increased occurrence of HVAC failure, as a consequence of ASD malfunction due to voltage dips (the ASDs considered are based on passive front-end technology), has been reported in one of the plants (Plant C in Figure 7-18). The HVAC failures caused total plant shutdown, leading to appreciable loss in revenue, long plant down-time for cleaning and restarting, and frustration among staff. Preliminary investigation found that these failures are direct consequence of ASD malfunction, coinciding with voltage dip events recorded at the 11kV main switchboard at the site entrance.

³ The text of this appendix has been provided by S.C. Vegunta and J.V. Milanovic, University of Manchester, Manchester, UK. The methodologies and terminology used in this appendix may be different from the ones used in the rest of the report.

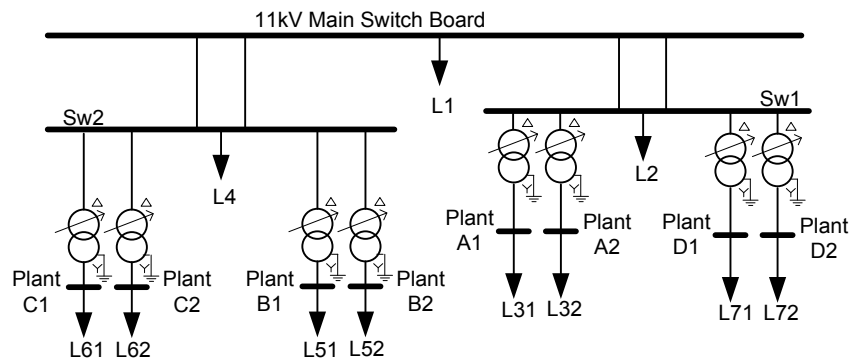

Figure 7-18 Single-line diagram of the local network (Load L4 feeds Plant D and others).

A Voltage Dip Monitor (VDM) placed at the 11kV Main Switch Board records all voltage disturbance events at this level. The VDM is configured to retain and store voltage dip information for each phase in a tabular format, i.e. the voltage dip magnitude and duration. Recorded voltage dip magnitude in each phase is the lowest rms voltage reached during the dip, and the dip duration is the longest duration among the three phases.

Manufacturing plant

The positive static air pressure of the plant's (Plant A, B, C or D) core sterile area (production area) is maintained by two sets of fan pairs: a pair for clean air supply and a pair for exhaust. As mentioned previously, all plants were designed to meet an N-1 security criterion. Each fan from the pair operates at 50% of nominal motor speed, and in the unlikely event that one fails (fan's speed falls below speed threshold of 0.083 pu), the Plant Control System (PCS) commands the other drive to ramp-up to full speed, to compensate for the incurred loss in air volume.

Although there are other fans controlling the static air pressures at the outer layers of the sterile core production area, failure of any fan among the sterile core supply or exhaust pair will cause a breach in sterility as a consequence of air reversal, leading to total plant shutdown.

Most of the low-power sensitive equipment, like PCs, servers, PLCs and data loggers, have a UPS back up, while high-power equipment, like ASDs, X-ray machines, etc., are vulnerable to voltage disturbances. Among various plant equipment sensitive to voltage dips and interruptions, the ASD were found to be the most sensitive and cause of plant stoppages, leading to substantial financial losses.

Study approach

The approach chosen to analyse plant sensitivity to voltage disturbances is a "bottom-up" approach and can be summarised as follows:

- Establish process sensitivity to loss of air supply.

- Establish relationship between parameters that affect process sensitivity and equipment controlling these parameters.

- Identify equipment behaviour and the cause of its malfunction to localise the problem area.

- Analyse potential voltage dip profile (available at the plant input terminals) variation through voltage dip propagation studies.

- Determine plant's annual trip frequency.

The above objectives are broadly categorised into three parts: voltage dip propagation, ASD's voltage tolerance, and HVAC system tolerance. Each of the parts is discussed below.

Voltage dip propagation study

In order to analyse voltage dip propagation from High Voltage (HV) buses representing the PCCs to Low Voltage (LV) buses, the relevant part of local distribution network is modelled with aggregated loads in PSCAD/EMTDC, as shown in Figure 7-18.

Two types of loads are considered: static and dynamic. The static loads consist of lighting, resistive heating, etc., and are represented as a function of voltage and frequency. Real and reactive powers are considered separately using the following equations [1,2]:

$$P = P_o \left(\frac{V}{V_o} \right)^{NP} (1 + K_{PF} \Delta F) \quad (1)$$

$$Q = Q_o \left(\frac{V}{V_o} \right)^{NQ} (1 + K_{QF} \Delta F) \quad (2)$$

where: P and Q are equivalent load real and reactive power, respectively. P_o and Q_o are rated real and reactive power per phase, respectively. V and V_o are loads voltage and rated load voltage (rms, phase-to-ground), respectively. NP and NQ are real and reactive power voltage exponents. K_{PF} and K_{QF} are frequency indices for real and reactive power, respectively. ΔF is frequency variation.

The coefficients, NP and NQ are typically chosen to be 0, 1, and 2, corresponding to constant power, constant current and constant impedance load types, respectively [2]. For most practical cases, frequency dependence of loads is not modelled, due to a very narrow range of frequency variations. In terms of system voltage support following voltage disturbances, constant power loads are the most inflexible, as they do not change with voltage drop. Constant impedance loads, on the other hand, are very "voltage supportive" as with the drop in voltage the load demand drops with the square of voltage (i.e., 20% in voltage reduction results in 36% reduction in load demand). From the network voltage and angular stability point of view, therefore, constant power loads represent the most critical type of the load [3].

Dynamic loads, i.e., loads that respond dynamically to voltage changes (exponential or oscillatory recovery), primarily comprise electrical (mostly induction) motors, tap changing transformers, thermostatically controlled loads, etc. Depending on their size and participation in total load demand, motors can have significant influence on bus voltages following the disturbance in the network.

Representation and detailed modelling of all types of loads in the plant is beyond the scope of this study and hence only five case studies have been considered, reflecting critical load compositions identified in the similar studies in the past: Case 1- constant power load; Case 2 - constant current load; Case 3- constant impedance load; Case 4 - combination of IM load and constant power load; Case 5 - combination of IM load, constant power load and constant impedance load.

The voltage dip monitoring equipment is connected at 11kV Switch Board, where it monitors and captures all voltage dip events. Each of the captured voltage dips is an aggregation of all the effects caused by the loads (static and dynamic) at that bus. For the purpose of analysing voltage dip propagation from 11kV bus down to the connection of critical process, a Voltage Dip Generator (VDG) with zero source impedance is connected to this 11kV bus. A zero impedance source is chosen so that the 11kV bus voltage can be fully controlled by the voltage dip generator.

Observations from Case 1, Case 2, and Case 3

Initially, all aggregated loads at each bus in the network are modelled as constant power, constant current and constant impedance loads for Case 1, Case 2, and Case 3, respectively (Table 7-3). The load frequency dependence is ignored.

Table 7-3. Considered case studies.

Case study number	Description
Case 1	Constant power load
Case 2	Constant current load
Case 3	Constant impedance load
Case 4	Combination of IM load and constant power load
Case 5	Combination of IM load, constant power load and constant impedance load

For Case 1, following a symmetrical three-phase voltage dip, the transformer secondary voltages follow the primary voltages, i.e., a 0.5 p.u. three-phase dip at primary produces 0.5 p.u. three-phase dip on the transformer secondary side. For asymmetrical voltage dips, characteristics at the secondary of the transformer are different from those at the primary. This change in voltage dip characteristics at the transformer secondary depends on the transformer’s admittance matrix (varies with vector configuration), sequence voltages and sequence load currents [4]. When a 0.5 p.u. generalised⁴ two-phase dip was applied at the 11kV Switch Board, the Plant C transformer terminals saw a 0.73 p.u. voltage dip in two phases and a 0.48 p.u. voltage dip in the third phase (i.e. a generalised single-phase dip). Similarly, 0.5 p.u. single-phase dip resulted in 0.97 p.u. voltage dip in one phase and a 0.73 p.u. voltage dip in the other two phases. Similar behaviour was observed in Cases 2 and 3 (Figure 7-19), with differences in voltage dip magnitudes at the transformer secondary of about 1-2%. The voltage dip magnitudes at the secondary improved whenever the load was modelled using a “more responsive/supportive load model”, i.e., the highest dip magnitudes were obtained with constant impedance loads and the lowest with constant power loads.

⁴ Generalised single-phase and two-phase voltage dips are defined similarly to Type I and Type II dips. For more details see: S. Ž. Djokić, J. V. Milanović, D. Chapman, M. McGranaghan, and D. S. Kirschen, “A New Method for Classification and Presentation of Voltage Reduction Events”, *IEEE Trans. on Power Delivery*, Vol. 20, No. 4, pp. 2576-2584, October 2005.

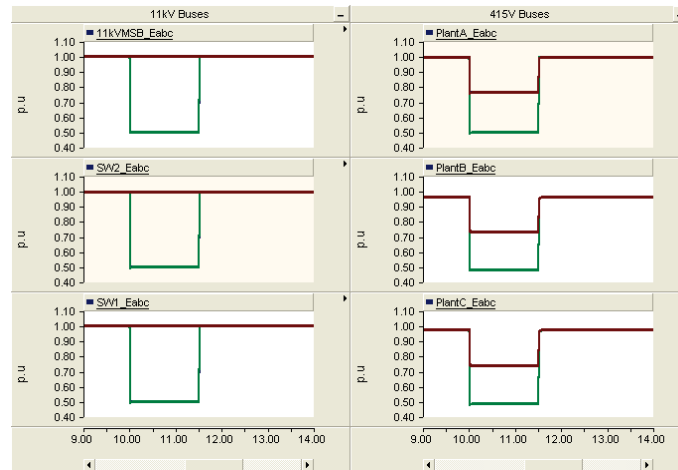

Figure 7-19. Case 3, typical voltage responses to 50%, 1.5s two-phase dips at 11kV (at Plant B and Plant C), resulting in an asymmetrical three-phase (i.e. generalised single-phase or Type I) dip at 415V (e.g. Plant C: 74% at Phase A, 48% at Phase B, 74% at Phase C).

Observations from Case 4, and Case 5

In Case 4, the load seen at each of the buses is split into IM and constant power loads in the proportions shown in Table 7-4.

Note: The above load distribution at PCC is considered due to a considerable amount of different load types (lighting, heating, etc.) connected in addition to drives and IMs. Other buses feed the production plants with substantial amount of drives and motors compared to other loads.

Table 7-4. Case 4 distribution system load composition.

Bus name(s)	IM load	Constant power load
PCC	50%	50%
All other buses	80%	20%

Since the previous case studies demonstrated that the type of static load has little influence on voltage dip characteristics, only the most critical constant power load is considered here.

When the same dips as in previous three cases were applied at the PCC, the voltage responses were similar in terms on how transformer changes the dip characteristics. The induction motors, however, cause a short delay in reaching final during-dip magnitude and introduce prolonged voltage recovery. When the voltage at the PCC recovers to nominal value, the plant side voltage reaches only 70-80% of the nominal value and then gradually recovers as the motors re-accelerate. The dip magnitude at the time of fault clearing depends on various factors including voltage dip severity, motor internal parameters (size, resistance and inductances), applied load inertia, etc.

It was also found that the Plant C bus voltage exhibits much quicker recovery compared to Plant A and Plant B buses. This is due to the fact that Plant C motor load consists of smaller motors and motors operating with a higher power factor.

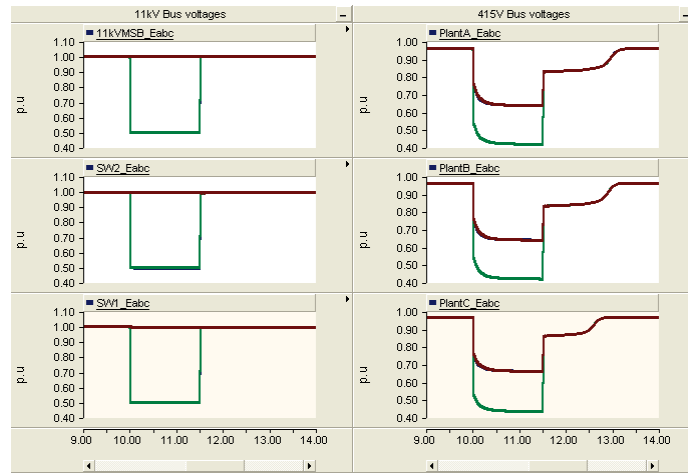

Figure 7-20. Case 5, typical voltage responses to 50%, 1.5s two-phase dips at 11kV (at Plant B and Plant C), resulting in an asymmetrical three-phase (i.e. generalised single-phase or Type I) dip at 415V (e.g. Plant C: 66% at Phase A, 44% at Phase B, 66% at Phase C).

Case 5 from Table 7-3 was a logical extension of the Case 4, with slight change in load distribution. The portion of constant power load considered in the previous case is halved to include constant impedance load. Voltage responses observed were very similar to those of Case 4, confirming previous findings that static loads have negligible influence on dip characteristics.

Plant sensitivity analysis

Voltage dips monitored at the 11kV Switch Board include the effect of loads fed through various feeders. The monitoring system stores only those dips whose magnitude falls below 0.95 p.u. (of bus rated voltage). Recorded voltage dip magnitude in each phase is the lowest rms voltage reached during the dip, and the dip duration is the longest among the three phases. During a voltage dip event, the dip monitoring system does not provide information on the unaffected phases, other than the knowledge that it is above 0.95 p.u. Hence, for simplicity and to consider the worst-case scenario, it is assumed that unaffected phase falls to 0.96 p.u. during a voltage dip event.

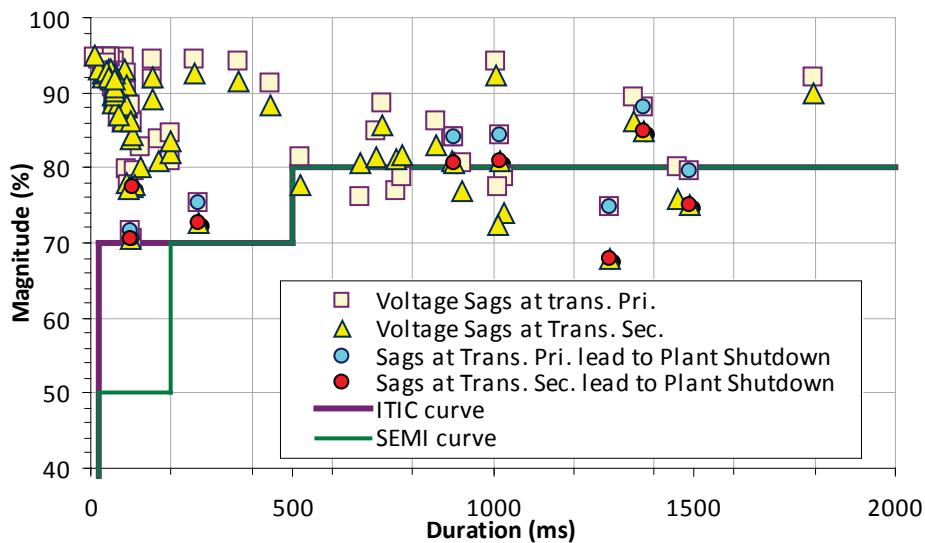

Figure 7-21. Effect of transformers on voltage dip severity and Plant C sensitivity.

Using the distribution network model presented in Figure 7-18 and constant impedance load model, all the voltage dips recorded at the 11kV substation are transformed to those seen at Plant C terminals. The recorded voltage dips for a period of nearly three years (01 Jan, 2004 – 31 Jan, 2007) at the primary substation and corresponding dips observed at Plant C terminal are plotted in Figure 7-21. Only the worst affected phase (with the minimum voltage magnitude) is presented.

The plant shutdown events corresponding to voltage dips at the transformer primary and transformed voltage dips to transformer secondary that are known to have caused the shutdown are also shown (red darker dots for transformer secondary and blue lighter dots for transformer primary). The critical events were all three-phase dips.

The results presented in Figure 7-21 suggest that all except two of the recorded voltage dips have magnitude of 70% and above, and became slightly more severe at equipment terminals due to the effect of transformers (all Dyn11 at this site). Also, it can be seen that the voltage dips that caused plant shutdown had magnitudes in the range 70-85%. These values could be used (at least initially and as a guide) for specifying the ride through requirements for any plant-level (e.g. Plant C) voltage dip recovery device (e.g. STATCOM, DVR, etc.) in the future. It is interesting to note that 6 out of the 8 dips (4 points were above the curve while 2 were on the curve itself) that are known to have caused plant shut were above SEMI curve and hence they should not have caused any problem to plant equipment.

ASD tolerance to voltage disturbances

Adjustable speed drive model

A typical passive front-end ASD was modelled in PSCAD based on the measurements (dc link capacitance and inductance, drive and motor's input and output power, voltage and current ratings, etc.) and parameters (motor equivalent circuit and nameplate data, drive protection system settings, etc.) that were taken from the drive and motor of one of the fans.

Two closed-loop drive control schemes were implemented in the model: Volts-Hertz (V-Hz) and Field-oriented Control (FOC). The control schemes were adopted from [5, 6 and 7]. The drive protection system models were adopted from [7] and the actual drive manual.

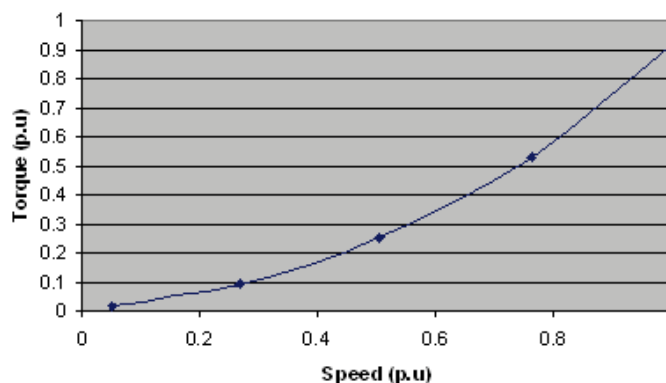

Figure 7-22. Measured torque-speed curve of the fan.

The model includes Under-Voltage Control (UVC, realised through regeneration) and “flying restart” capability. The UVC principle relies on the load’s kinetic energy to maintain the dc link voltage. For UVC principle to be effective, the motor and load mechanical rotating parts need to accumulate enough kinetic energy that can be harnessed during disturbance to maintain dc link voltage constant. The accumulated kinetic energy is a function of the sum of motor and load inertia, and operating speed. For the case study considered here, it was found through simulations that for a typical voltage dip (0.8 p.u., 1.5s) at the site entrance the ASD should drive the fan at speed >0.7 p.u. for the UVC to be effective. The inertia of the sample drive system was measured to be 8.67kg.m².

The UVC control is implemented by ramping down the drive’s output frequency quickly to zero, when the UVC is activated by drive protection circuit, thus converting motor into a generator drawing energy from the load. The control circuit tracks the motor speed during regeneration and drive trip scenarios, so when the drive is turned on, it picks the speeds from that instance and ramps-up to the set point if flying restart or UVC is enabled.

To accurately represent the fan-load model, a load test experiment was carried out on the chosen test drive. The motor output speed was varied and amount of load was directly read from the drive keypad, resulting in a fan torque-speed curve (Figure 7-22). This curve is used as a lookup table, to adjust the load torque at corresponding operating speeds.

The ASD model in simulations was powered by the voltage dip generator (VDG) model, which generates a rated power supply condition with additional functionality to produce desired voltage independently in each of the three phases at any point in time, of any dip magnitude, duration and phase jump. The VDG model (power circuit, logic circuit and control pane) implemented in simulations is adopted from [8].

ASD tolerance to dips

A significant difference in voltage tolerance and ride-through capability is observed between V-Hz and FOC based ASD when subjected to voltage dips (Figure 1-23).

Figure 7-25 illustrates these observed characteristics in detail. ASDs that are widely available in the market have usually two lines of defence: voltage tolerance (how much the equipment can tolerate the departure of the input voltage from the nominal) and ride-through (if it trips, how quickly it can restart and reach normal operating conditions). The voltage tolerance is related to drive’s component and overall ratings, internal protection system settings, inverter control algorithms, operating conditions, etc, while the ride-through restoration time depends on initial operating conditions, hardware and software restart delays and settings, etc.

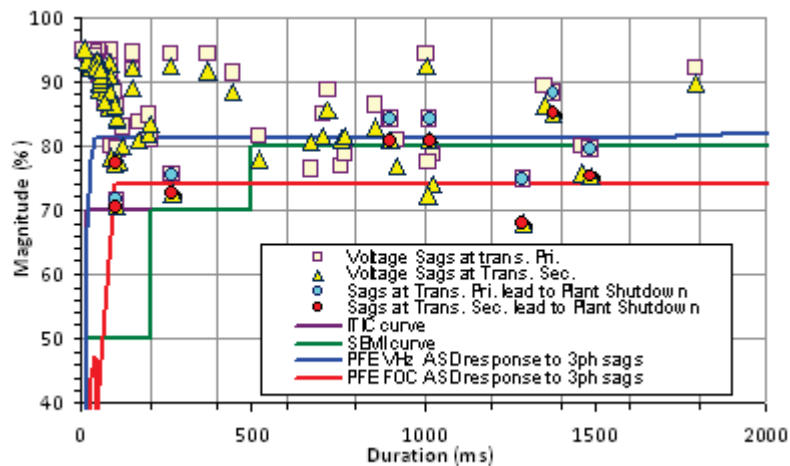

Figure 1-23. Voltage- tolerance curves of ASDs laid on plant/supply voltage dip profile (Figure 7-21).

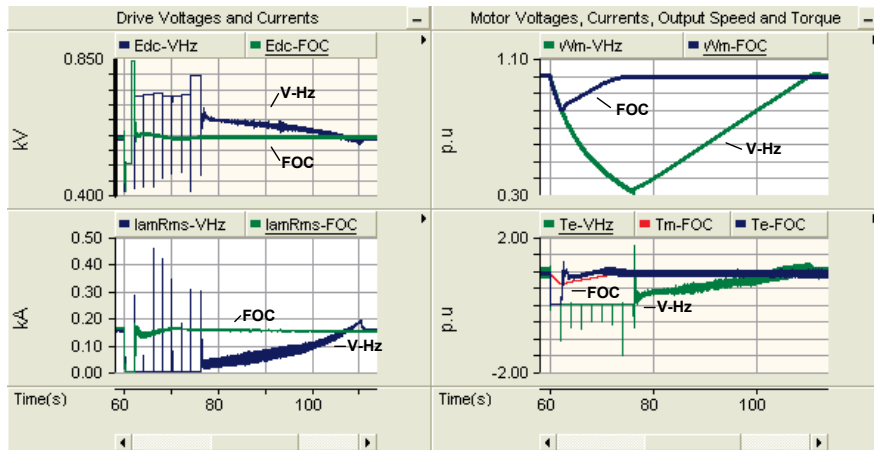

Figure 7-24. Flying restart performance of modelled ASDs with disabled under-voltage control.

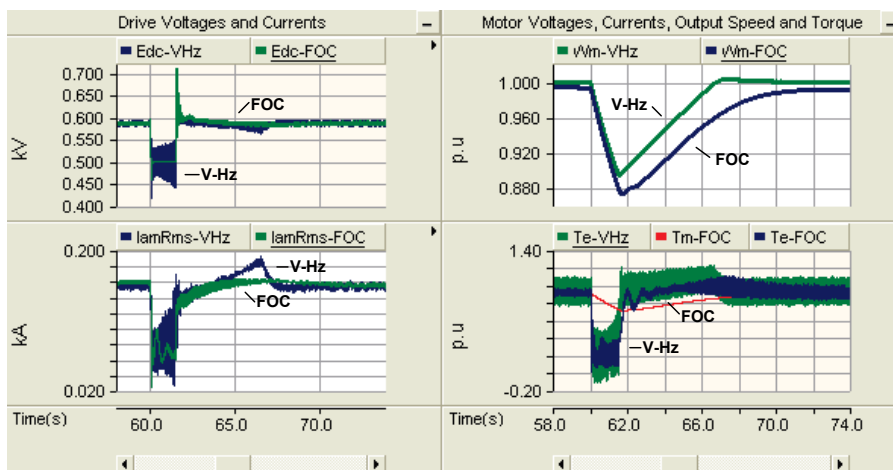

Figure 7-25. Under-voltage control performance of modelled ASDs.

Voltage-tolerance curves are widely used to assess ASD's voltage-tolerance performance. Each voltage-tolerance curve is specific to the drive's initial operating condition and test criteria. They are usually obtained through: testing, trip recording over a long period, and simulations. Voltage-tolerance curves obtained through simulations using the developed

ASD's models describe drive response with respect to the type of dip and process sensitivity. When the ASD's voltage-tolerance curves are laid over the plant's curve-scatter plots or voltage dip profile, one could roughly estimate the number of times the equipment (or the plant in this case, as tripping of ASD caused plant shutdown) is likely to trip (Figure 1 7-23). The plant voltage-dip profile or curve-scatter plots are obtained from recorded voltage dips (at the 11kV Switch Board). This is illustrated in Figure 1-23 using ASD's (both V-Hz and FOC) voltage tolerance curves to three-phase dips (0° phase shift and 0° point-on-wave of initiation) at nominal operating conditions. It is noted that V-Hz controlled ASD's are more sensitive than industry recommended ITIC and SEMI curves, however, the FOC controlled ASD's voltage-tolerance curve lies outside (with exception of its left top knee) the ITIC and SEMI curves, is less sensitive and is likely to ride through 50% (4 out of 8) of dips that lead to process disruption.

Figure 7-24 shows the drive's flying restart performance under both control schemes, i.e. V-Hz and FOC, and trip performance during the process of flying restart. The drive under V-Hz control mode took several attempts (trip of over-current protection) to restart before it started re-acceleration to set speed. The number of attempts that it had before it could re-accelerate reduced with operating speed. However due to effective current control in FOC, irrespective of the drive's operating load, it restarted at the very first attempt.

Figure 7-25 illustrates the effectiveness of UVC in providing ASD dip ride-through, by maintaining the dc link voltage at the set value. A drive (under both control schemes, i.e. V-Hz and FOC) operating at nominal speed increases the likelihood of voltage dip ride-through, as it benefits from kinetic buffering through UVC. Operation at 50% of the rated speed, however, does not offer the same benefits, as the regeneration functionality becomes less effective due to the reduced load of the drive (and therefore reduced accumulated kinetic energy), limiting its ride-through capability.

Table 7-5 and 7-6 summarise the observed characteristics of V-Hz and FOC control drives under various test conditions.

Table 7-5. Test characteristic and applied test criteria.

	Characteristic	Test voltage dip applied
1	Flying restart without under-voltage control	FOC was more tolerant to typical dip (0.8 p.u., 1.5s three-phase dip), hence the following dip configuration is chosen: 0.6 p.u., 1.5s three-phase dip
2	Trip performance	0.6 p.u., 1.5s three-phase dip
3	Under-voltage control	0.8 p.u., 1.5s three-phase dip
4	Drive tolerance performance	Arbitrary three-phase, two-phase and single phase dips in dip magnitude-duration plane
5	Estimated number of trips based on plant terminal voltage dip profile	Plant's voltage dip profile

Table 7-6. V-Hz and FOC performance comparison.

	V-Hz	FOC
1	Drive successfully restarts on 8th attempt (approx. at 16s, as drive attempts to restart after every 2s). Poor recovery.	Drive successfully restarts on 1st attempt. Quick recovery.
2	Under-voltage protection causes the initial trip; later subsequent trips are in combination with over-current protection system.	Under-voltage protection causes the initial trip; however the drive recovers immediately at the first restart attempt. This is due to improved torque and current control.
3	Speed falls by 0.105 p.u. in approximately 1.5s. Sustained dc link voltage oscillations. Increased torque ripples during regeneration. Increased inrush current at re-acceleration.	Speed falls by 0.12 p.u. in approximately 1.5s. Quickly damped dc link voltage oscillations. Relatively low torque ripples during regeneration. Relatively small inrush current is seen at re-acceleration.
4	Sensitive to single-phase dips. Less sensitive to two-phase dips than three-phase dips.	Not affected by single-phase dips. Relatively more voltage tolerant than V-Hz controlled drive for three-phase and two-phase dips.
5	7 potential trips, concluded from Figure 1-23.	4 potential trips

Effect of plant loading on plant shutdowns

Most of the processing plants (Plant B, Plant C, and Plant D) have drives of various sizes, continuously maintaining the production process environment conditions to meet various set sterility standards. The majority, if not all, of these ASDs drive a fan-load that is proportional to square of the operating speed.

If 'RPM', 'CFM', 'SP' and 'BHP' represent the fan speed, air volume flow rate, static pressure, and power respectively, then the following Fan Laws dictate their relationship [9-11].

Fan air volume flow rate is directly proportional to its operating speed,

$$CFM_2 = CFM_1 \cdot \left(\frac{RPM_2}{RPM_1} \right) \quad (3)$$

Fan static pressure is directly proportional to square of its operating speed,

$$SP_2 = SP_1 \cdot \left(\frac{RPM_2}{RPM_1} \right)^2 \quad (4)$$

Power drawn by the fan is directly proportional to cube of its operating speed,

$$BHP_2 = BHP_1 \cdot \left(\frac{RPM_2}{RPM_1} \right)^3 \quad (5)$$

When all the above equations, i.e., (3)-(5), are combined the following relation is derived,

$$\frac{BHP_2}{BHP_1} = \left(\frac{CFM_2}{CFM_1} \right)^3 = \left(\frac{RPM_2}{RPM_1} \right)^3 = \left(\frac{SP_2}{SP_1} \right)^{1.5} \quad (6)$$

A plant drive-speed survey was conducted on selected plants in the test manufacturing facility. Visual inspection of these results presented in Table 7-7 show that 21% and 7% of drives in some of the sub-processes of Plant C and Plant B, respectively, operate at speeds above 0.8 p.u., while 36%, 33%, 32% and 31% of the drives in other sub-processes of Plants B, C and D, respectively, operate at speeds between 0.64-0.8 p.u. Adding up these two speed ranges shows that Plant C has most (53%) of drives operating at speeds higher than 0.64 p.u., followed by Plant B with 40% of the drives operating at speeds above 0.64 p.u. This also indicates that Plant C is more heavily loaded, and as a consequence, more likely to be affected by voltage dips than Plant B and Plant D.

Table 7-7. Proportion of individual plant load.

Plant name	Drive operating speed range (p.u.)			
	< 0.5	0.5 – 0.64	0.64-0.8	0.8 <
Plant B process	0%	64%	36%	0%
Plant B packing	17%	43%	33%	7%
Plant C	0%	47%	32%	21%
Plant D	0%	69%	31%	0%

HVAC system tolerance

When subjected to a disturbance (e.g. HVAC failure, human error, component failure, etc.), the Process Immunity Time (PIT) is the amount of time taken before any of the process critical parameters (e.g. pressure regimes at the sterile core, volume deviations, etc.) reach their critical limits. The Plant Equipment Control Time Constant (PECTC) is the amount of time taken by the plant or specific equipment to restore the system, following a disturbance, to a pre-disturbance state or a state that will ensure process continuity. For a successful ride-through, the PECTC value should be less than PIT value.

From a HVAC sterile environment’s perspective, PIT depends on the initial plant operating regimes (e.g. differential pressures, air flows, etc.) and leakages within the system. Following a disturbance, the PIT may be used as a specification for any action taken by process control equipment to restore the system back to normal, if it is configured to such automatic restoration action.

Data collected on Plant C during both independent tests and voltage dip plant-shutdown scenarios were used to evaluate the PIT. In two independent dip-caused plant-shutdowns, the differential pressures collapse (reach warning/low limit level) within 34 sec when both the supply fans fail (Figure 7-26) and within 30 sec when one among the pair of supply fans fail (Figure 7-27). This indicated that process pressure regime at the production area took a longer time to collapse when both supply fans fail simultaneously than when only one among the pair of supply fans fail. This is because of the fact that when only one of the fans fail, the air is still circulating, causing the pressures to drop. However when all the fans fail simultaneously, the air circulation is reduced, maintaining pressures at the plant’s sterile region. Hence, only a “one fan fails” scenario was considered during tests, reflecting the worst case. According to fan laws, volume of the air blown by the fan is directly proportional to the fan speed. This is reflected in Figure 7.26b (both fans fail) and Figure 7-27b (one fan among the pair fails and unaffected fan maintains the speed until the Plant Control System (PCS) detects the failure and ramps it to full speed).

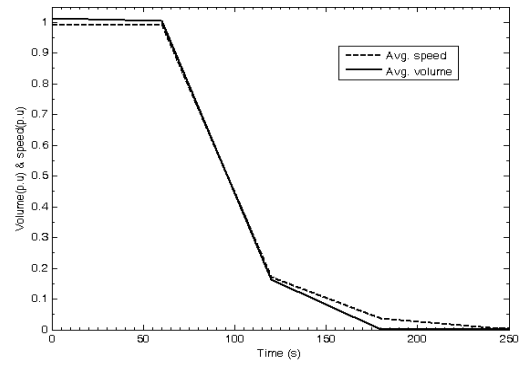
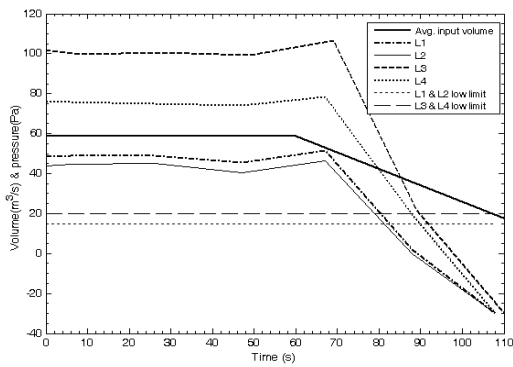

a. Differential pressure responses at various process critical locations (L1-L4). Volume scaled up by factor 4.
 b. Volume response to fan's speed response.

Figure 7-26. Process response to voltage dips on (21/06/2006), when both fans failed.

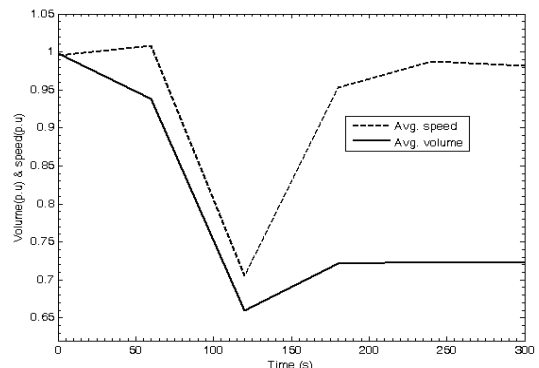
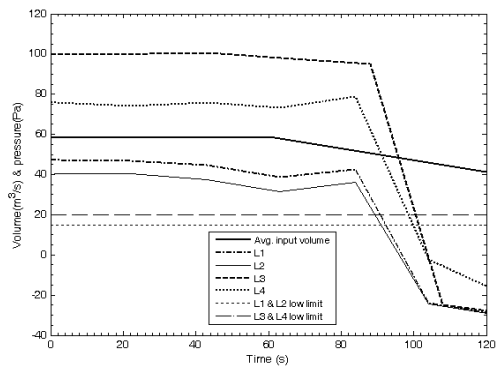

a. Differential pressure responses at various process critical locations (L1-L4). Volume scaled up by factor 4.
 b. Volume response to fan's speed response.

Figure 7-27. Process response to voltage dips on (02/07/2006), when only one among the supply fans failed.

The test results of Figure 7-28 show that when one among the pair of supply fans was forced to trip, the PCS ramps the other (still operating) fan to 100% speed. Though ramping up the other fan restores the pressures at process critical locations, the slow ramp-up-rate of the unaffected fan and delayed response time of PCS caused the pressures to dip, and lead to negative differential pressures.

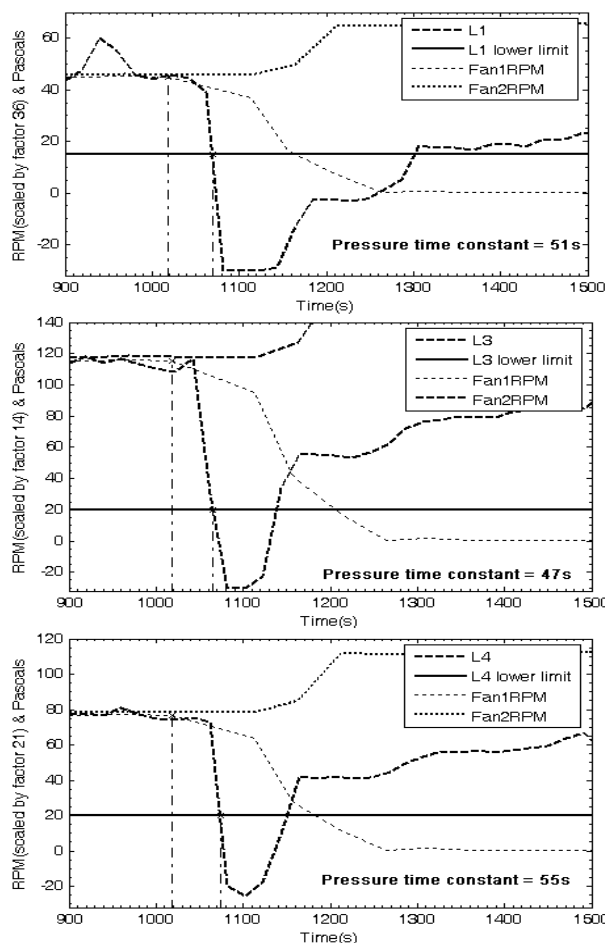

Figure 7-28. One fan fail test (08/06/2007).

All process critical differential pressures completely collapsed even before the unaffected fan begins to ramp to 100% speed. The PIT for each of selected critical locations under test is indicated in Figure 8.

Considering the worst-case scenario, the minimum PIT is estimated to be 30s. As the Facility Management System (FMS, which monitors plant's operating conditions) has a sampling time of 20 s, the PIT could deviate $\pm 10s$, resulting in worst-case scenario PIT of 20 s. This 20 s leeway is amount of time within which the PCS will have to detect the drop in fan speed and ramp up the speed of the other fan from the pair to 100% in order to restore the pressure at the production area.

The results presented in Figure 7-26 to 7-28 suggest that the PIT is roughly within a range of 20-45 s, considering the worst-case scenario. This is also the time within which the process control equipment, following its malfunction, should restart and restore the system to a nominal/acceptable/non-critical level of operation, thus PECTC < 20-45 s. This should be part of the specification, when procuring new sensitive equipment.

Investigation of various process control scenarios

Based on the results and discussions presented in the previous sections, it is clear that sensitivity of a plant's process widely depends on: plant loading condition, system configuration (volume and pressure requirements; ASDs, their design, internal set

parameters, ramp rate, and combination and robustness of various internal control schemes etc.), as well as on power distribution system site configuration.

One simple way of reducing ASD sensitivity (which in this case study represents the overall plant's sensitivity) is by reducing its operating speed, if the process does allow this. ASDs at Plant C drive a fan load, where operating speed dictates the operating torque, and reducing the speed results in reduced operating load. In most industrial applications this is achieved by introducing a pulley mechanism (usually at the motor side) or through ASD's speed reference signal.

A pulley or the pulley-belt mechanism, transfers one set of speed and torque to another set of speed and torque, by maintaining the sending and receiving power fairly equal, when friction losses are neglected. ASD's sensitivity reduces with reduction in both operating speed and load torque. However, a pulley does not provide any benefits, as the effective power drawn from ASD remains that same. Currently, literature or analysis of the effect of introduction of pulleys on ASD's sensitivity is lacking. The study presented here gives reasoning to engineers why introducing pulleys may not be effective in reducing ASD's sensitivity driving a fan load.

The most economical and practical pulley to replace is the motor pulley. The motor pulley is less costly, and it is also easy to change compared to load pulley, and as the smaller of the two pulleys, it probably has the greatest wear on it. The smaller pulley will always wear the fastest, as it is turning at the higher speed and it has a smaller circumference for the belt to spread the wear over.

This section explores various potential solutions and scenarios in order to arrive at the most optimum solution, while taking into account the consequences, such as: solution feasibility and commissioning, time frame, costs and modifications to existing system. Two scenarios are considered: taking into account N-1 design criterion and ignoring it.

Taking into account N-1 design criterion

As mentioned previously, the plant (drive-motor-fan system, power supply, etc.) under study was originally designed to meet an N-1 security criterion. Each of the pairs of fans is operated at 50% of nominal motor speed, so in case that one fails, the other ramps up its speed to compensate the loss. However, due to an increase in volume requirements over time, both fans were found to operate at 76% of their nominal speeds. The N-1 security design criterion facilitates system running for loss of any one component (ASD, motor or fan) either due to electrical or mechanical failure. The following sub-sections will present the investigation, assuming that frequent occurrence of electrical and mechanical failures.

Current operating scenario

An experimental load test was carried out on one of the supply fans in Plant C, to establish the fan load curve. The drive's output speed was varied and the amount of load was directly read from the drive keypad, resulting in a fan load curve as shown in Figure 7-22 and

Figure 7-29. This curve is used here to conduct further analysis to estimate system changes and new specifications if required, based on the N-1 security criterion.

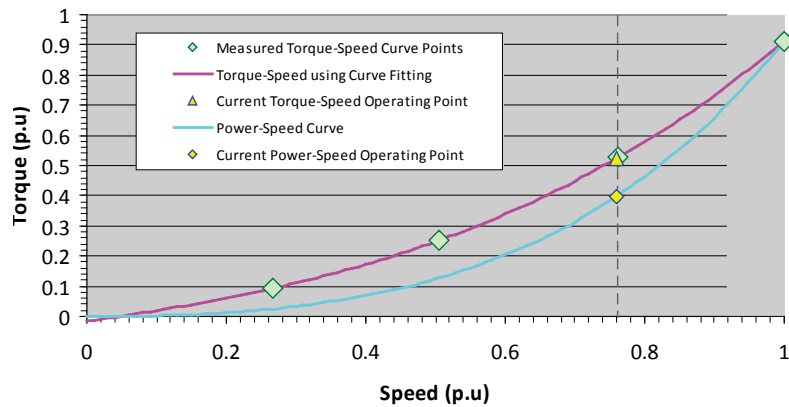

Figure 7-29. Load and power curve of existing fan load.

The measured load curve points obtained from the load-test experiment are clearly marked as shown in

Figure 7-29. A polynomial curve fitting technique is used to establish a mathematical relation between load torque and speed. The following polynomial equation provides the best fit for measured points at Figure 7-29:

$$T_L = 0.0405\omega_m^3 + 0.1945\omega_m^2 + 0.32839\omega_m - 0.0159 \quad (7)$$

The current operating point ($\omega_m = 0.76 p.u.$) on the torque-speed curve is also marked in Figure 7-29. The resultant power-speed curve is obtained using the relation $P = T_L \cdot \omega_m$. It should be noted that for any given torque-speed characteristic of the load, the drive's operating point will always follow the load curve in steady-state.

The power-speed curve thus obtained is more concave than the torque-speed curve, and the vertical projection of operating point on torque-speed curve (yellow triangle in Figure 7-29) on the power-speed curve represents the corresponding operating point on the power-speed characteristic of the load (yellow diamond in Figure 7-29).

Inverter, motor and fan specifications to meet N-1 security criterion

The analysis in this section proceeds to introduce new drives and motors to meet new torque-speed curve specification experienced by the motor with introduction of pulley-belt system. The load curves, i.e. fan load curve ($k = 1$) and motor load curve (with pulley-belt system, $k = 1.52$), are extended further using (5) and (6) as shown in Figure 7-30a, such that motor load curve ($k = 1.52$) meets 1 p.u. speed threshold. The fan load curve ($k = 1$) is also extended to a point where the end point relates (yellow square box with red perimeter aligns vertically with yellow square box with blue perimeter at 1 p.u. speed in Figure 7-30a) to motor load curve at 1 p.u. speed threshold.

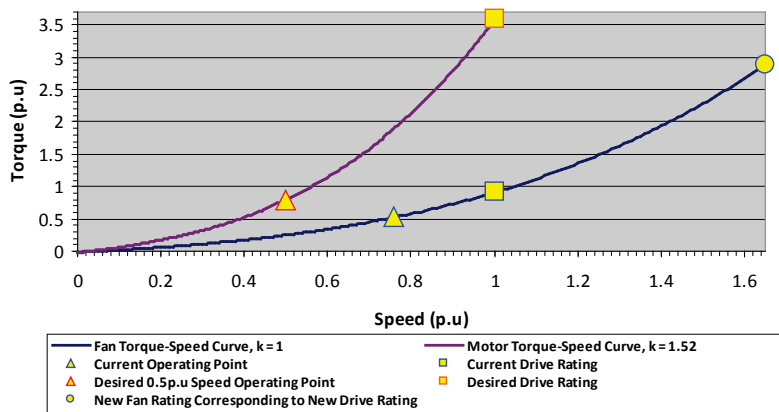

a. Torque-speed curves.

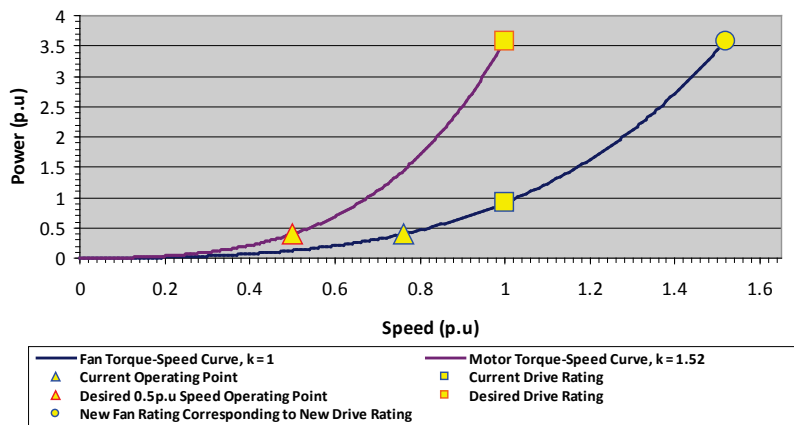

b. Power-speed curves.

Figure 7-30. Power-speed and torque speed curves for new drive, motor and fan ratings.

Required new specifications to follow N-1 criterion

Table 7-8 presents estimated equipment specifications to follow N-1 criterion.

Table 7-8. Current and estimated new device ratings taking N-1 security criterion into account.

Device	Current rating	Estimated new rating
Pulley-belt system	Not installed, $k = 1$	$k = 1.52$
Drive and motor	1 p.u. torque 1 p.u. power 1 p.u. speed	3.583 p.u. torque 3.583 p.u. power 1 p.u. speed
Fan	1 p.u. speed	1.65 p.u. speed

Summary

For any manufacturing plant, disruption of the process is of paramount concern, and any solution or recommendation therefore should take into account the tolerance of the process parameters to deviations in performance of the equipment controlling them. In the case study presented here, it is found that the ASDs, which control process environment, represent the weakest link.

The following recommendations can be drawn based on presented case study:

- An understanding of processes, process conditions, their limits and sensitivity to change in control has been established.
- The weakest links in the process chain that are sensitive to voltage disturbance directly/indirectly have been identified.
- Equipment sensitivity and control configuration options to voltage dips have been evaluated. (This may require liaising with equipment manufacturer and in case of ASDs these options may include: i) Reducing the ASD loading if possible; if this can not be done, slightly oversized drives should be installed, ii) Procurement of high performance drives (e.g. Field Oriented Control, Direct Torque Control), able to control torque and current, thus limiting the high inrush currents; they could also provide increased immunity to voltage dips compared to conventional V-Hz controlled drives, iii) Under-Voltage Control ride-through scheme utilises the loads kinetic energy to maintain dc link voltage; however, it is important to assess its steep speed ramp-down rate and speed drop impact on the process parameters to insure UVC's adequacy.)
- Establish plant's voltage dip profile through voltage dip propagation studies.
- Quantify cost of disruptions due to voltage dip to justify future investment in mitigating solution.

Implementation of change in system configuration (introducing new fans, motors, inverters, etc.) using previously discussed analysis and N-1 security criterion is likely to have the following advantages and disadvantages. (These conclusions are strictly valid for the case study considered here and, to some extent, to systems with similar configurations.)

Advantages with N-1 security criterion:

- The system will meet N-1 security criterion, as originally intended, in order to have backup during a mechanical failure (e.g. belt slipping, ball bearing failure etc.) and repair.
- Provides reduced ASD sensitivity to voltage dips with reduced load.

Disadvantages with N-1 security criterion:

- Changes in system configuration may include vast range of modifications, and will require considerable engineering effort (external contractors) for installation. This is a very expensive solution and is only suitable for new plant.
- Even after implementing the required changes, the reliability of the system will still depend on robustness of the drive's tolerance to dips and ramp up time to compensate the loss in the event one drive (from the pair) trips.
- Space constraints may put additional limitations on any new installation.

On the other hand, emphasis on drive's ride through capabilities with respect to voltage dips will have the following advantages and disadvantages:

Advantages without N-1 security criterion:

- No vast modification of system configuration is required.
- The idea of system overload (fans operating at 76% speed) vanishes and instead the remaining 24% speed capacity could be utilised in case of increased volume demand.
- Much cheaper solution compared to potentially significant modification of the system.

Disadvantages without N-1 security criterion:

- Though mechanical failures were rarely observed over the period of last 8 years, the occurrence of one could bring the whole HVAC system to halt. However, this could be reduced by regular maintenance.

References

- [1] "PSCAD 4.1 User's Guide," Manitoba HVDC Research Centre Inc., Manitoba, Canada 2004.
- [2] "Load representation for dynamic performance analysis [of power systems]," *IEEE Transactions on Power Systems*, vol. 8, pp. 472-482, 1993.
- [3] M. H. Kent, W. R. Schmus, F. A. McCrackin, and W. L. M., "Dynamic Modeling of Loads in Stability Studies," *IEEE Transactions on Power Apparatus and Systems*, vol. PAS-88, pp. 756-763, 1969.
- [4] M. T. Aung and J. V. Milanovic, "The influence of transformer winding connections on the propagation of voltage dips," *IEEE Transactions on Power Delivery*, vol. 21, pp. 262-269, 2006.
- [5] P. C. Krause, O. Wasynczuk, and S. D. Sudhoff, *Analysis of Electric Machinery and Drive Systems*, 2nd ed. Piscataway: Wiley-IEEE Press, 2002.
- [6] "SimPowerSystems online documentation: Field-Oriented Control Induction Motor Drive," The MathWorks Inc.
- [7] M. Barnes, *Practical Variable Speed Drives and Power Electronics*, 1st ed: Newnes, 2003.
- [8] S. Z. Djokic, J. V. Milanovic, and K. A. Charalambous, "Computer simulation of voltage dip generator," 10th International Conference on Harmonics and Quality of Power, pp. 649-654 vol.2, 2002.
- [9] P. Rosenberg, *HVAC/R Professional Reference*, Master ed. Pottstown: Pal Publications Inc., 2006.
- [10] F. P. Blietier, *Fan Handbook: Selection, Application and Design*: McGraw-Hill Professional, 1998.
- [11] P. Rosenberg, *HVAC Pal*, Miniature ed: Pal Publications, 1999.
- [12] S. Z. Djokic, K. Stockman, J. V. Milanovic, J. J. M. Desmet, and R. Belmans, "Sensitivity of AC adjustable speed drives to voltage dips and short interruptions," *IEEE Transactions on Power Delivery*, vol. 20, pp. 494-505, 2005.

Appendix 7.D: Testing documentation requirement

Documentation of test report shall be as per the latest IEC 61000 4 11/34, or SEMI F47 standards. Find below the key requirements:

- Type designation of the equipment under test (EUT), EUT manufacturer, manufacturer address, and manufacturer primary phone contact information, model number and serial number
- The test date
- The test location
- Any conditions of use for the EUT and test arrangements, such as voltage range limitations, required modifications, process limitations, equipment configuration(s), special/unusual installation requirements, etc.
- The range of model numbers and/or serial numbers to which test results apply
- Information on possible connections (plugs, terminals, etc.) and corresponding/required cables, and peripherals; dedicated protection circuits and their default settings and allowed ranges for re-adjustment
- Input power port(s) of equipment to be tested
- Information about the cold-start and hot-restart inrush current requirements of the equipment
- The EUT should be tested in a representative operational mode, e.g.:
 - Relevant loads and loading conditions
 - Expected environmental temperature
 - Expected environmental humidity
 -
- Performance criteria to which equipment was tested (full operation, self-recovery, and assisted-recovery) need to be documented in details:
 - What are the (technical) allowed tolerances and deviations for full operation criterion
 - How long the self-recovery takes and what is the behavior of EUT
 - What is the behavior for the assisted-recovery and what needs to be done in order to manually restart the equipment
- Test generator used
 - For equipment with input nominal current over 250 A, or for equipment where required tests can not be done, simulations are accepted, but should be fully described and validated
- Test result for each measurement point of the voltage dip immunity labels
- the qualifications/authorisation of the engineers who performed or participated in the testing
- The voltage and current waveforms for all phases, including pre-dip and post-dip data, for at least a single worst-case voltage dip (worst-case being defined by the largest current drawn by the EUT, either during or after a voltage dip)

- A complete list and description of all dips applied during the testing, including for each dip: the phase(s) to which the dip was applied, the depth and duration of the dip, the process state of the EUT, the results of the dip, and any other useful comments or observations on equipment performance during and after the dip
- Any other important recommendations and/or conclusions that resulted from the testing

8 Need for Further Work

Much has been achieved by the Working Group but a number of issues have not yet been resolved. In addition a number of new issues arose from the work done by the Working Group. Finally, a number of issues have not been addressed by the Working Group, mainly due to lack of resources. In this chapter, some of the issues will be presented that, according to the Working Group, should receive more attention in the future.

Some of the future work is most appropriate for academic studies. In other cases practical work is needed or new working groups should be formed.

8.1 Chapter 2: A description of voltage dips

The description of voltage dips presented in this report is based on dividing a dip into transition segments and event segments. The characteristics of event segments are well understood and described in detail in the report. However, further work is needed on the characteristics of transition segments.

A basic methodology is needed for quantifying voltage-dip characteristics. One challenge is to develop methods for automatic detection of transition segments. Commonly-accepted methods are also needed for quantifying the proposed characteristics of event and transition segments. These methods, when they become available, should be used to obtain statistics about these new characteristics. Statistics on voltage-dip unbalance (Type I, Type II or Type III) are needed as a basis for discussions on equipment immunity requirements, and are important information for end-users when applying the methodology introduced in Chapter 7 of this report. Statistics on phase-angle jump and point-on-wave may be useful at a later stage. The summary of voltage-dip characteristics (known informally as the “checklist”) is aimed at providing equipment developers with a method for anticipating dip-related immunity problems at an early stage. Feedback is needed from equipment developers regarding the usefulness of such a checklist. If the list is useful, similar checklists could be developed for other types of power-quality disturbances.

8.2 Chapter 3: Assessment of equipment and process immunity

More information is needed on the impact of repetitive dips (e.g. due to reclosing into a sustained fault) on equipment immunity. Potential equipment damage due to repetitive dips should be investigated. Further work is also needed to quantify the impact of the pre-dip voltage, and the impact of the source impedance, on equipment immunity against voltage dips. Also restart mechanisms and restart time for equipment need to be determined.

Validation of the process-immunity time is needed for fast processes. The Working Group recommends starting a new activity, composed predominantly of end-users, to quantify the process-immunity time for different types of industrial processes. The results of such a study would assist, indirectly, to quantify the economic losses due to voltage dips. More generally, it is still not known what level of immunity is typical of a well-designed industrial installation.

Further work is needed to understand end-user equipment immunity to other power-quality disturbances; such as voltage swells, long-duration overvoltages, and long-duration undervoltages. The end-user equipment should include commonly-used domestic and office equipment.

8.3 Chapter 4: Immunity testing and characterization

The Working Group failed to reach consensus regarding test vectors for testing against three-phase unbalanced voltage dips. The resulting compromise, to allow a number of different test vectors, is seen by several members as a temporary compromise but unacceptable as a permanent solution. The majority of the Working Group members concluded that we recommend to IEC to allow any set of test vectors mentioned in the IEC standards. However, following the same reasoning, other members argued that we neither have sufficient information to disagree with the practice of disallowing one set of test vectors, as prescribed in the existing version of the IEC standards. Further work on this is strongly encouraged.

Fundamental work is needed to estimate the error made by applying test vectors that are a simplification of reality. Although our analysis of the voltage-dip database has shown that some test vectors are closer to reality than others, the Working Group is aware of the fact that no simple set of test vectors can reproduce the range of voltage dips that occur in reality. The estimation of the error made should proceed along the same lines as the illustrative example for phase-angle jump. Guidelines to initiate such a study are included in an annex to Chapter 4. The economic consequences of prescribing a specific set of test vectors should also be considered. This holds especially for compliance testing, and, to a lesser extent, for characterization testing.

In this report, the Working Group recommends that characteristics like phase-angle jump and point-on-wave not be included in the characterization testing. Even when such characteristics were included, there would not be any method available for presenting the results in such a way that a comparison could be made with equipment immunity. The development of methods similar to the voltage-dip contour chart is needed for including additional characteristics in the testing of equipment that is especially sensitive to these characteristics.

The occurrence of multiple dips within a short period of time (e.g. due to reclosing into a sustained fault) was recognized and discussed at length within the Working Group. However due to lack of available data, no recommendation could be given. The Working Group recommends further work on this issue, in which manufacturers would provide information on the impact of multiple events on their equipment and network operators would provide information on the occurrence of multiple events. There is especially concern due to reports about damage to equipment because of multiple voltage-dip or short-interruption events.

The Working Group did not reach a clear conclusion about including Type III dips in compliance testing. Although the Working Group recommends including Type III dips in the compliance testing, further work is needed to determine appropriate immunity objectives. The economic consequences of including Type III

dips in the compliance testing should be better understood and considered in this further work. Close cooperation with equipment manufacturers is needed here.

The work in this report has been restricted to voltage dips. Further work is needed on immunity testing for short interruptions, swells, and voltage magnitude variations.

8.4 Chapter 5: Economics of voltage dip immunity

Power-quality economics is within the scope of CIGRE/CIREC Joint Working Group C4.107. The need for further work on this subject will also result from the conclusions reached by Joint Working Group C4.107.

During several of the discussions within our Working Group, the lack of economic data prevented us from reaching a conclusion or making a recommendation. This especially concerns the economic consequences of decisions that impact all equipment, such as dip immunity standards. A considerable amount of further work is needed. The results of such work are an essential foundation for setting standards-based dip immunity requirements.

8.5 Chapter 6: Statistics

The global data base created by the working group is the first of its type and it will be a very good base for further enlargement and contributions. By adding data from more countries and systems, the data will become more globally representative. It is important that the data is sufficiently representative for equipment in industrial installations as well as for all equipment. The former is important, among others, for the discussion on which immunity requirements to place on industrial equipment in accordance with the different immunity classes discussed in Chapter 7 of this report. A representative set of data for voltage dips as experienced at the equipment terminals is important input to the discussion on what are appropriate immunity requirements that all equipment should comply with.

The need to obtain voltage-dip data before setting immunity requirements is well understood by the Working Group. It is however also understood that this is not a sufficient incentive to network operators and others for gathering this data. Other applications for voltage-dip statistics could be found that would justify gathering this data in a global database.

The way in which the results of the global database are presented in this report (using percentiles and contour charts for the three dip types) could serve as a template for presenting the results of national voltage-dip surveys.

8.6 Chapter 7: Dip immunity classes and application

The Working Group selected the immunity requirements for the five classes using the available information about the economic consequences of the selection made. The curves should obviously be seen as one of many possible choices. The Working Group encourages others to continue this work and to come with alternative immunity requirements based on more information. The Working Group especially encourages equipment designers to suggest less expensive alternatives.

Multiple case studies, covering a range of production process types, would help to evaluate the methods proposed in this report for selecting electrical equipment. Especially the detailed use of the process immunity time needs to be evaluated.

8.7 Other power quality disturbances

The work in this report has been restricted to voltage dips. Further work is needed on immunity requirements for short interruptions, swells, and voltage magnitude variations. The results presented in this report may serve as a basis for that work.

9 Conclusions

This chapter summarizes the main contributions made by the Working Group.

9.1 Chapter 2: A description of voltage dips

The Working Group has created a detailed description of the different properties and characteristics of voltage dips. This description divides the voltage waveform into pre-dip, during-dip and recovery segments. Special emphasis has been placed on the three-phase character and the occasional non-rectangular character of voltage dips.

Based on this detailed description a summary of voltage-dip characteristics has been created that may be used by equipment manufacturers and researchers as a checklist when they development new equipment. For voltage dips in three-phase systems the Working Group accepted a classification that is based on the number of phase-to-neutral voltages that show a significant drop in magnitude. The three types of dips (Type I, Type II and Type III) correspond to a significant drop in magnitude for one, two or three phase-to-neutral voltages, respectively.

It is pointed out that measurement of phase-to-neutral voltages gives more information but that the phase-to-phase voltages are more relevant for voltage-dip statistics on medium-voltage and high-voltage networks. Only for low-voltage networks with phase-to-neutral connected loads (as are common in most countries) should the phase-to-neutral voltages form the basis for voltage-dip statistics.

9.2 Chapter 3: assessment of equipment and process immunity

The Working Group has presented an overview of the immunity of different types of equipment against voltage dips. The impact of voltage-dip characteristics (magnitude, duration and others) on equipment immunity is illustrated in a quantitative way.

The Working Group introduced a useful new concept, "process-immunity time". A distinction is made between equipment failure and process failure. This distinction allows better economic assessment of the impact of dips on industrial installations. A methodology has been developed for analysing an entire process, and finding a process immunity time for each individual device or section of that process.

9.3 Chapter 4: immunity testing and characterization

The Working Group has made a careful distinction between characterization testing and compliance testing. Guidelines are given for characterizing dip immunity of equipment. The Working Group proposed that the immunity of equipment be presented as a "voltage tolerance curve", which is one simple way for equipment manufacturers and users of their equipment to communicate about dip immunity.

The Working Group recommends that compliance testing includes only two dip characteristics: residual voltage (magnitude) and duration. Based on the presently available knowledge, the Working Group does not

see sufficient justification to perform additional tests covering characteristics such as phase-angle jump and point-on-wave.

For characterization testing of three-phase equipment, the Working Group recommends that the equipment immunity be presented by voltage tolerance curves for each of the three types of dips introduced in Chapter 2. The working group recognizes that it may not be practical to exactly reproduce the unbalanced voltage dips introduced in Chapter 2. In many cases approximations need to be made to allow the use of available test equipment. The Working Group is not able to argue for or against any of the methods due to lack of information that any of the methods is significantly less likely to accurately assess compatibility between equipment and the system.

For compliance testing of three-phase equipment the Working Group recommends including tests for Type I, Type II and Type III dips. The statistical data gathered in Chapter 6 shows that a significant number of dips are of Type III. However due to a lack of data about the economic consequences of including Type III dips in the compliance testing, the Working Group gives no recommendations regarding the form in which Type III dips should be included in compliance testing.

9.4 Chapter 5: economics of voltage dip immunity

The economics of voltage-dip immunity have been described in a qualitative way. A distinction is drawn between dip immunity of individual installations, and dip immunity requirements that are placed on all equipment through standards. The economics of dip immunity at individual installations are well understood, but for a specific installation the data may not always be available. The steps in quantifying the economics of dip immunity at individual installations are described in detail in this report.

So far, the economics of setting global standards for equipment dip immunity are still not understood. The discussions within the Working Group have resulted in a high-level description of the economics involved. The Working Group concluded that economics play an important role in selecting the appropriate voltage-dip immunity, both for individual installations and for immunity requirements that impact all equipment.

9.5 Chapter 6: statistics

A global database of voltage-dip statistics has been created. This database includes statistics from several countries on several continents. The database has permitted the Working Group to reach new insights about the ratio between balanced and unbalanced dips, about the variation in number of dips between different sites, about the appropriateness of different equipment immunity requirements, and about the characteristics of three-phase test vectors, among other dip-related questions.

The results of the database analysis are presented as a set of contour charts for Type I, Type II and Type III dips. These contour charts vary significantly for different sites, so a percentile method is used to describe worst-case sites, median sites, and so on.

9.6 Chapter 7: Dip immunity classes and application

A number of voltage dip immunity classes and associate curves are introduced. These classes will further simplify communication between equipment manufacturers and equipment end-users about dip immunity, while at the same time allowing equipment end-users a sufficient level of choice in selecting equipment. Test levels (combinations of duration and voltage magnitude; for each of the three types of dips) for each class are proposed.

The Working Group emphasizes that performance criteria (how the equipment recovers after a dip-induced trip) are a critical concept next to the immunity requirement. Three performance criteria are proposed: “full operation”; “self-recovery”; and “assisted recovery”. A “voltage-dip immunity label” is introduced that combines the immunity class with the performance criterion for a specific device.

Finally, a systematic methodology, based on the voltage-dip immunity label, is introduced for selecting electrical equipment to ensure a required level of dip immunity for an industrial process.